

REFERENCE GUIDE



>Machine
Vision



Datalogic Automation Machine Vision at a glance	4
Automotive	6
Electronics	8
Packaging	10
Medical & Pharma	12
General Manufacturing	14
Impact software: VPM and CPM	16
Tools and Controls	18
Machine vision basic principles	20
Vision sensors	24
Smart cameras	26
Vision processors	28
Digital cameras	30
Accessories	32
Training and Support	33



MACHINE VISION

The Machine Vision Business Unit of Datalogic Industrial Automation is built upon the acquisition of PPT Vision Inc. in 2011. For over 30 years, PPT Vision has focused exclusively on the development of machine vision technology for in-line automated inspection and factory automation. Thanks to its extensive experience of thousands of successful machine vision installations throughout the world, PPT has become a recognized world leader in machine vision innovation and has brought unique benefits to customers:

- **A single machine vision software platform** - Programming software that is flexible, powerful, and common to all smart cameras and embedded vision system products. This means no operator cross-training and no need to maintain different software platforms— just select the hardware you want and go! Transfer inspection programs from one camera to another and back again without redeveloping the application.
- **Flexibility and Security** – Control Panel Manager (CPM) - a control panel software that is not only secure, but field-configurable and common to all products. Protect your inspection and system configuration from unauthorized users, but allow qualified personnel as much flexibility as they need. CPM provides ultimate flexibility when compared to complicated software programming languages and allows you to create control panels in a mere fraction of the time. Connect and view data from one or many vision systems with just a click of a button.

- **Time-to-market** - Personalized, technically superior and committed customer support. We can provide you with as much support as you need when it comes to delivering application solutions. Choose one of our highly skilled and qualified application engineers or training specialists, or select a certified partner to guide you from application concept to installation and qualification of your system.
- **Large product portfolio** - Hardware platforms that allow our customers to expand their range of applications. From the simplest vision sensors to the highest performance embedded processors, we can deliver a vision system optimized for your inspection needs. Choose a smart camera in an inline or right angle version, color or greyscale sensor, CCD or CMOS sensor; it does not matter because we have you covered. For vision processors, select from a single to multi-headed area scan or line scan cameras that range from VGA to ultra-high resolution images.

Today, after completion of the integration process between Datalogic Industrial Automation and PPT Vision Inc., the combined product lines of the two companies encompasses both hardware and software while covering a wide range of performance and price point requirements. Selling through a global network of experienced distributor and integration partners, Datalogic Automation is the complete solution provider for all your machine vision needs.

TIMELINE

1982	1984	1991	1991	1994	1997	1997	2000	2001	2002	2002
Founded as Pattern Processing Technologies	APP 200 Series Vision System Introduced	Vision Process Controller (VPC) Product Released	Vision Program Manager (Classic) Software Released	PPT Vision releases the Passport Scout Product Lineup	PPT Acquires 3D Scanning Moiré Interferometry (SMI) Technology	DSL Vision System Introduced – World's First Full Digital Vision System	Microelectronics Product Group (MPG) Developed	PPT 861 3D Product released for Semiconductor Business	IMPACT C – Series Tethered Smart Camera Product Introduced	IMPACT Software Suite Released (Vision Program Manager & Control Panel Manager)

TECHNOLOGY



KEY BENEFITS

MACHINE VISION PRODUCT GROUPS

- Vision Sensors
- Smart Cameras
- Vision processors
- Machine Vision Software

Our complete family of high-performance smart cameras and embedded machine vision systems utilize the same software across all products. The hardware consists of vision sensors, smart cameras, and embedded vision systems. These products are specifically designed and developed by our engineers to meet all your manufacturing inspection requirements and to get your application up and running faster than anyone else in the industry – Guaranteed!

INNOVATION

Through continuous development and refinement, our product line is the most complete hardware and software solution available on the market today.

EXPERIENCE

With 30 years in the machine vision business and thousands of successful customer installations, our organization and your partners are able to solve the most challenging inspection applications within a wide variety of markets and manufacturing settings.

RESPONSIVENESS

Together with our global distribution and integration partners, pride our self on providing a level of training and support that is unmatched in the industry. We listen, then execute – turning our customers' requirements into solutions faster than anyone else.

2003

Integrates CameraLink into C-Series Processor

2003

OCR Software Released

2004

IMPACT T-Series In line Smart Camera Introduced

2005

Datalogic SCS1 Smart Camera Introduced

2006

IMPACT A-Series Right Angle Smart Camera Introduced

2007

Datalogic DataVS Vision Sensor introduced

2010

MX40 Multi camera vision processor Introduced

2010

New Improved Pattern Finding Software Released

2011

PPT Vision acquired by Datalogic

2012

PPT Vision Inc. becomes the Machine Vision BU of Datalogic Industrial Automation

2013

A30 and T4x-Series Smart Camera Introduced



AUTOMOTIVE

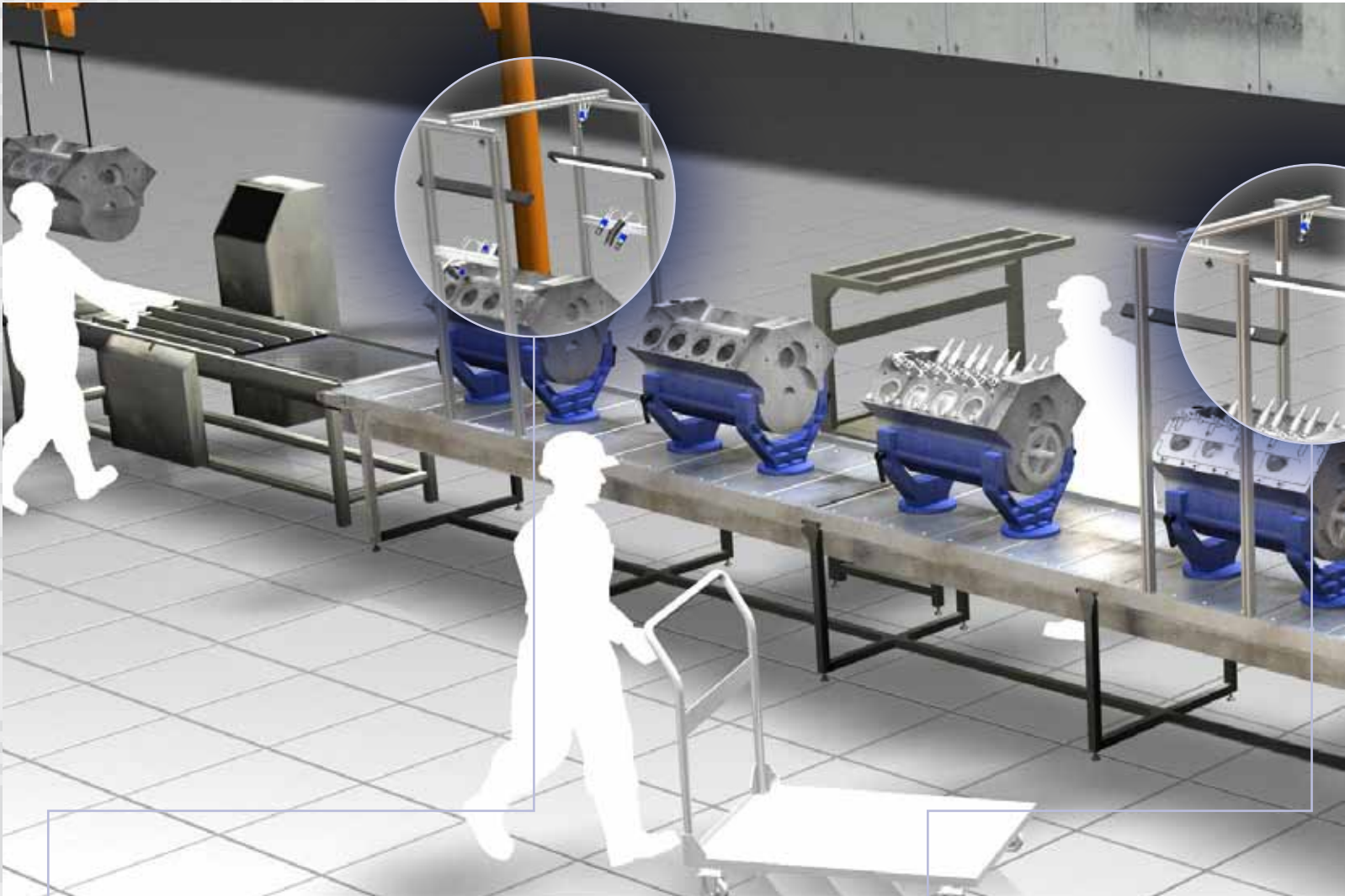

ENGINE BLOCK VERIFICATION



Allows manufacturers to verify and quantify the proper placement and size of critical bolt hole locations as well as to identify if secondary processes, such as thread tapping or surface machining, have been successfully completed. This type of early inspection prevents the manufacturer from adding more cost to defective materials or allows for the identification of flawed high value parts that can be reworked.

EPOXY BEAD VERIFICATION

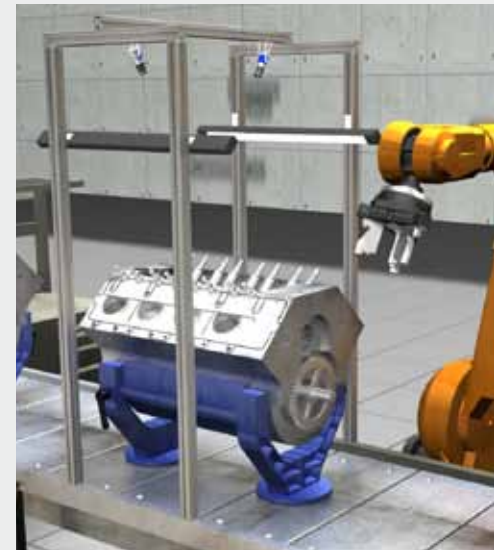

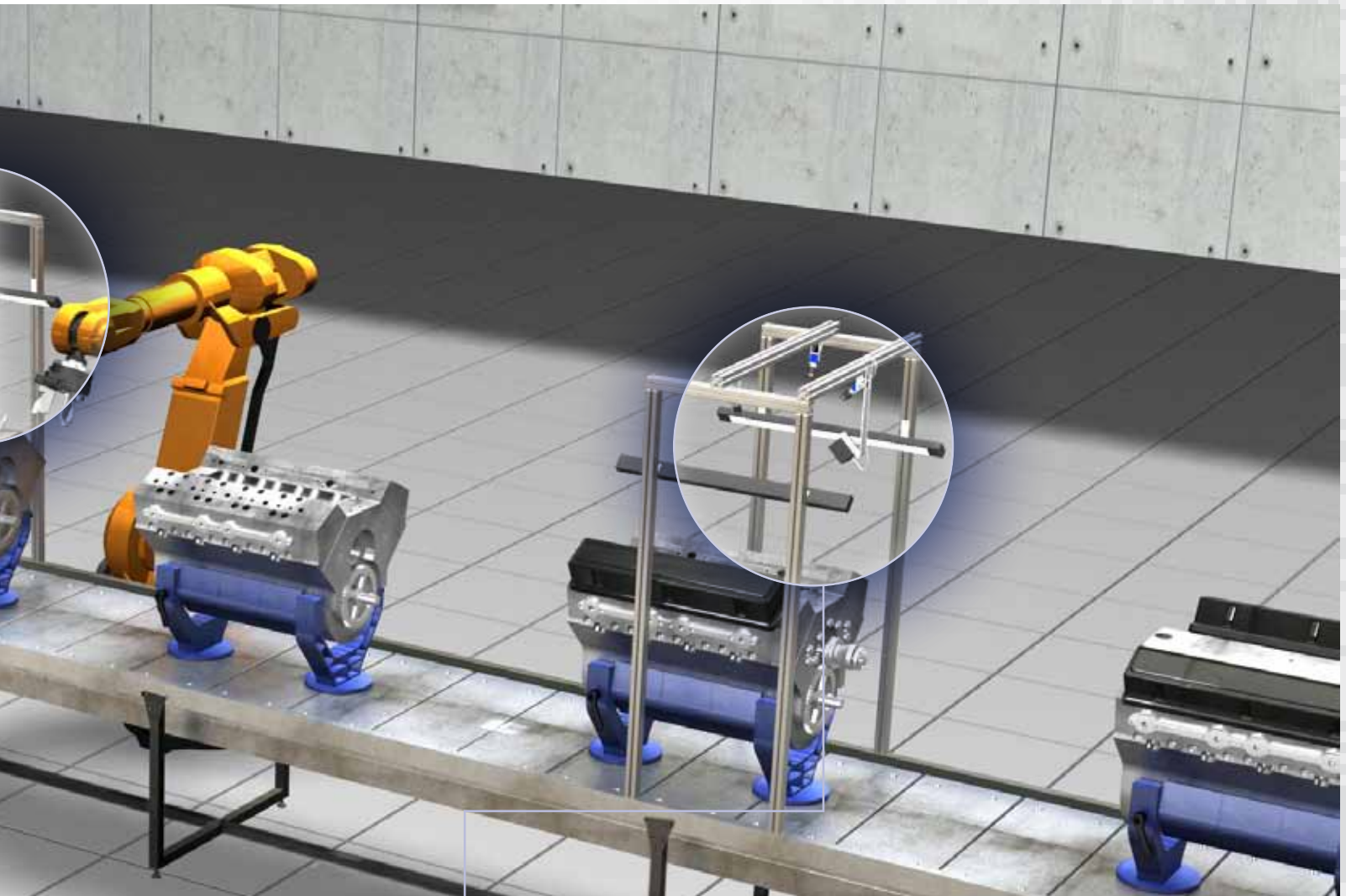

N



This verification checks for the proper placement, shape or quantity of a sealant or epoxy bead on a surface that will be mated with other critical surfaces or components. Damaged or improperly formed beads, identified by the system, can also indicate issues with the bead application process. Early identification of these problems can provide huge savings to the manufacturer as well reduced quality issues to the customer.

COMPONENT PRESENCE / POSITION



This inspection eliminates the need for manually verifying single or multiple features or components on a single assembly. These features may include proper orientation, right size or correct color as well as the ability to confirm multiple product configurations or variations. The benefit of 100% inspection, provided by the vision system, insures only the properly assembled product gets to the customer.

ELECTRONICS



RAW MATERIAL INSPECTION

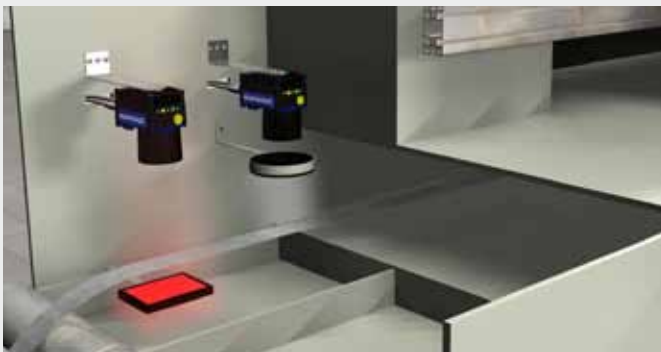

The pre-process inspection allows for inspection of raw material prior to secondary processing. This eliminates adding value to low quality material. In connector manufacturing, the strip width and pilot hole locations are critical to the process. Likewise, surface defects such as porosity, stains and scratch inspection is critical to the final product.

GOLD PLATING INSPECTION

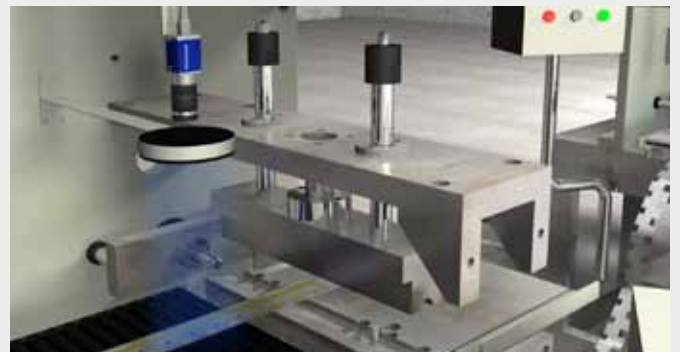

Post plating inspection provides assurance that highly value material such as gold is accurately placed in the correct position on the brass strip. 100% inspection of the plating allows the operator to monitor the process and make on the fly corrections to the high value continuous product with little or no downtime as well as low waste of processed material.



TRIMMED MATERIAL INSPECTION



Post stamping inspection verifies 100% dimensional tolerance acceptance on internal features that cannot be inspected, without destructive methods, after the secondary forming or assembly is completed. Other types of inspections that can be addressed simultaneously include burr detection and secondary plating inspection.

INSERT MOLDING INSPECTION



Insert molding inspection allows for verification of properly formed molded plastic housings as well as performing final measurement checks on critical dimensions of the connector. This inspection identifies areas of material shortage as well as excess material that can cause non sealing or locking conditions or excessive connector insertion forces.

PACKAGING



POST BAKING INSPECTION



This high speed inspection checks for the consistency of food products after coming out of the baking or frying process to guarantee the food is not over cooked or discolored and reducing customer complaints.

FRUIT CLUMP DETECTION



Clump detection identifies when certain types of food stick together to form large masses of food. Masses of food may not be fully processed or cooked, too large for the subsequent process and ultimately cause large amounts of waste or possible health concerns by being under processed.

CONTENT FILL AND MIX INSPECTION



The content fill inspection provides assurance that the product is properly placed in the package and verifies the presence of any secondary components before the sealing of the package. With a properly configured system additional information such as product fill height can also be determined. These inspections help to guarantee the customer always receives the correct amount of product.



OPEN FLAP DETECTION



Flap detection verifies all of the flaps on a box food package are fully formed and sealed to insure freshness of the product as well as uniform shape for secondary packing of the product and a positive visual effect for the customer.

EXPIRATION DATE PRESENCE



100% verification of date and lot codes and code quality can be accomplished with machine vision at extremely high rates of speed. This allows for traceability and regulation requirements of food products.

LABEL INSPECTION



Verifying the different variables on a label (e.g. product weight, cost, ingredients and current promotions) can be accomplished through the use of optical character recognition (OCR) as well as reading barcodes to identify product contents. This feature is especially important when tracking products that contain allergens or require the presence of other health related information on the label.

MEDICAL & PHARMA

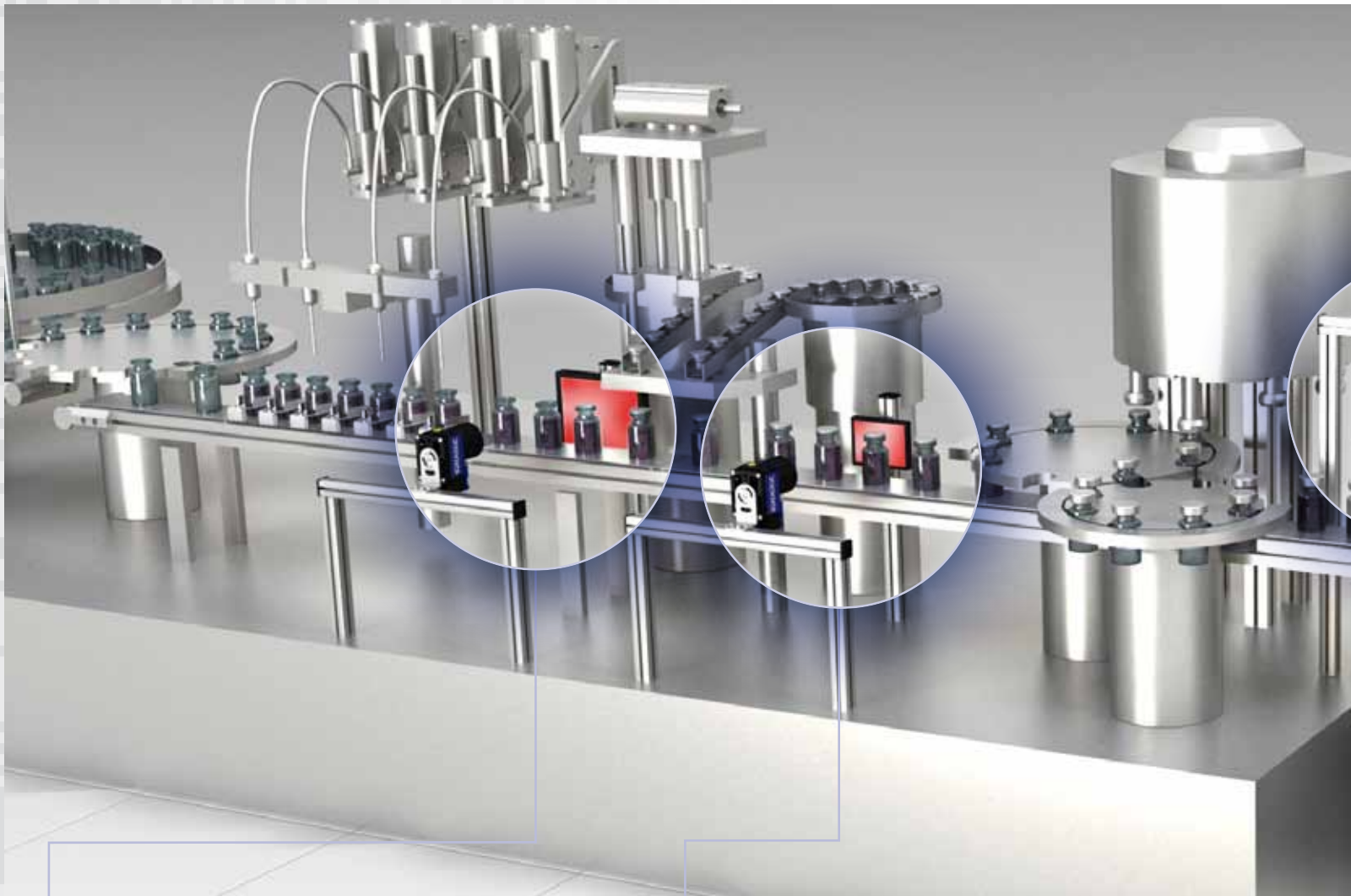

LIQUID LEVEL INSPECTION



This inspection provides for the amount of liquid in transparent bottles and can be done quickly and effectively through the use of machine vision. Properly applied, this inspection ensures the bottle is filled to specification while eliminating waste and costs associated with overfill or under fill conditions.

CAP INSPECTION



This inspection ensures the product quality by verifying the bottle cap is present and applied correctly. Normally, this inspection is performed at high rates of speed prior to the sealing and final packaging process where visual inspection is not possible without reopening the sealed package.

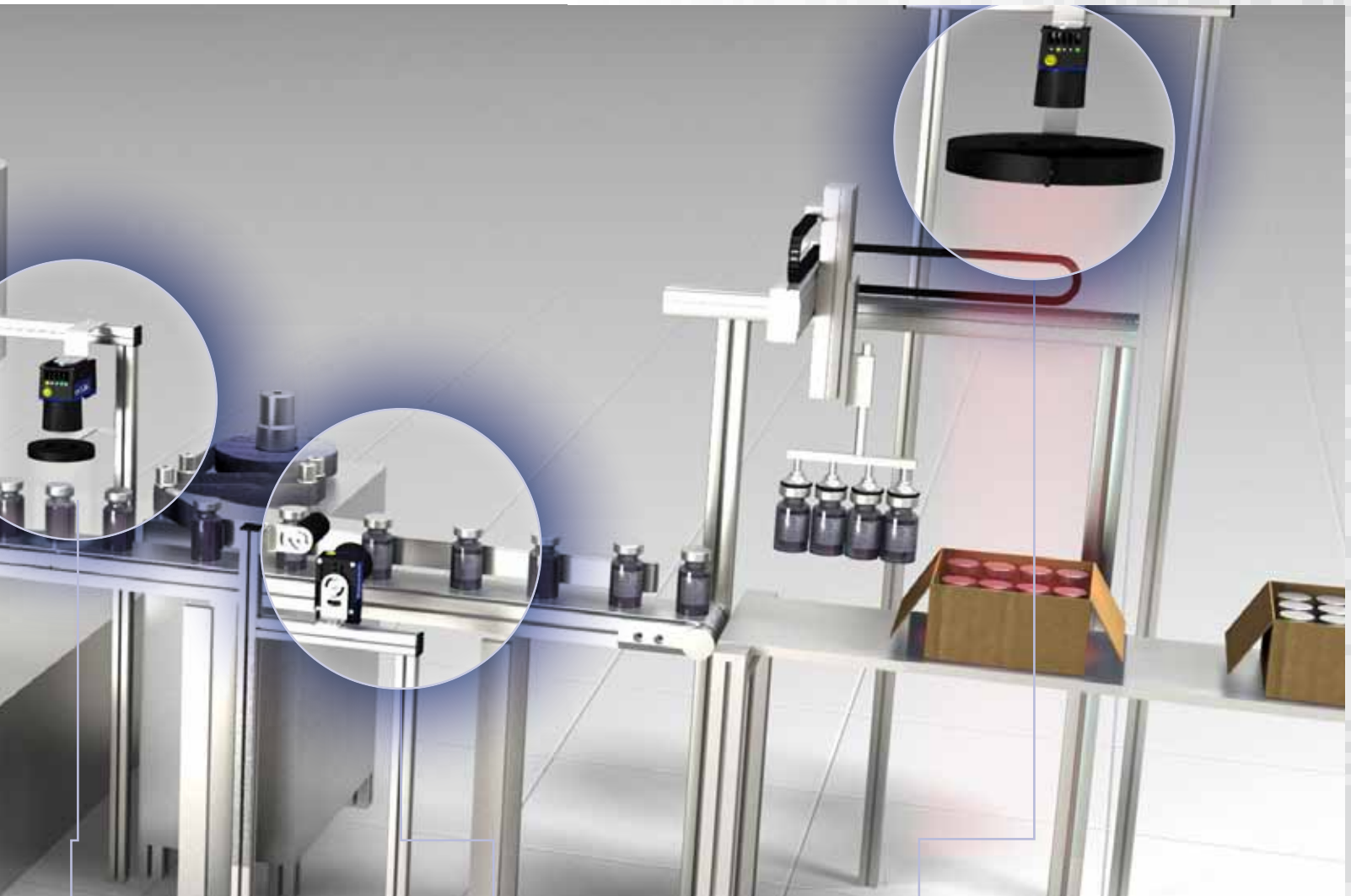

SAFETY SEAL INSPECTION



Verifies the product is protected with a properly applied tamper proof seal before leaving the factory or a clean area within the manufacturing facility. Ultimately, this inspection eliminates product contamination through the packaging integrity of the product.

LABEL INSPECTION



Checking for critical variable product information on labels (including product weight, ingredients, warnings, etc.) can be accomplished through the use of optical character recognition (OCR), barcode or matrix code readers – all available on smart cameras and vision systems. This feature is especially important when tracking products that contain materials that are ingested or require the presence of other health related information to be printed on the product label.

BOX INSPECTION



Allows the user to check for and verify the completeness of product packaging. This includes verification of the product count, product type and any miss-packaged or damaged items inside the product carton.

GENERAL MANUFACTURING

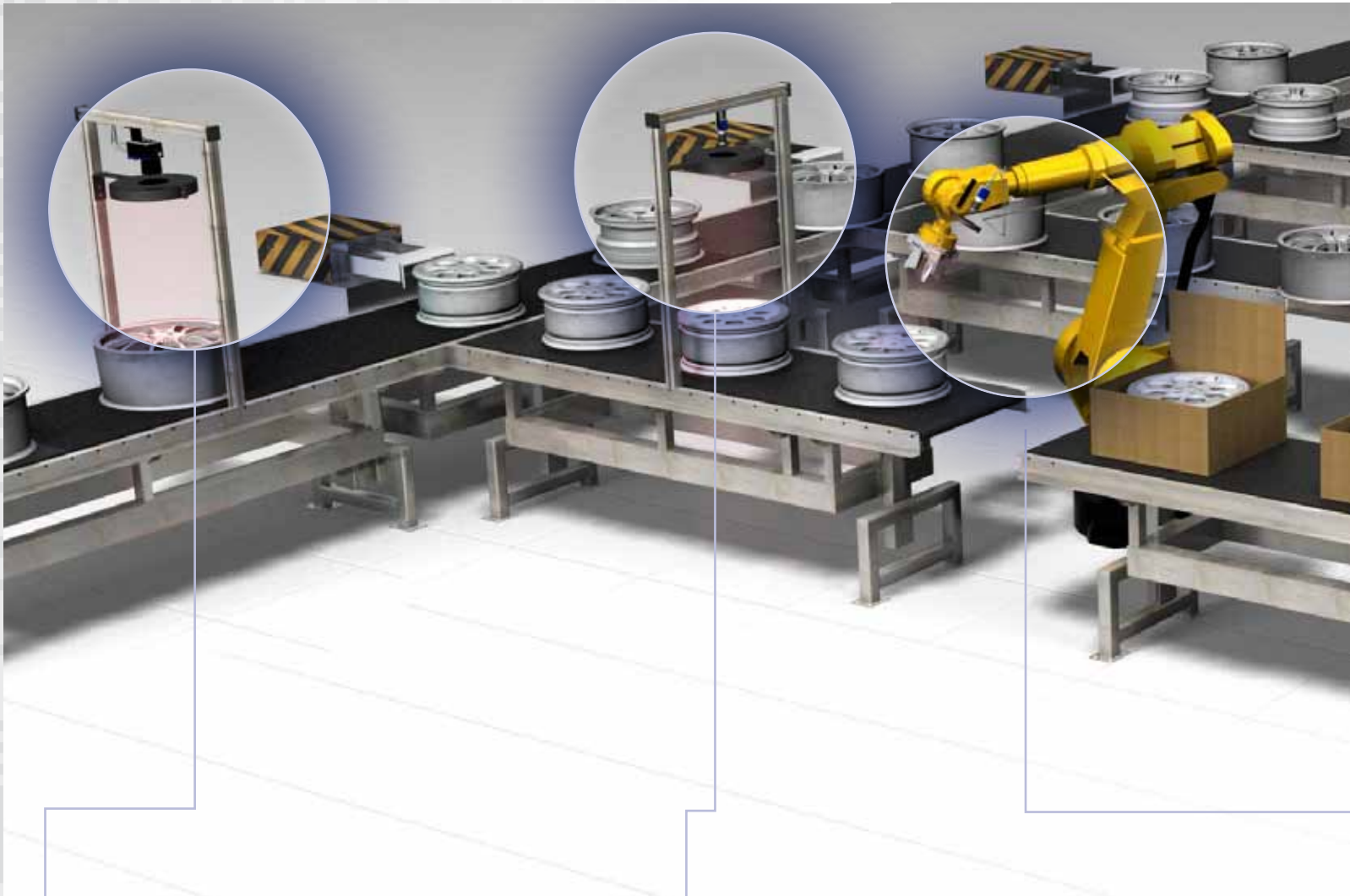

RIM SORTING

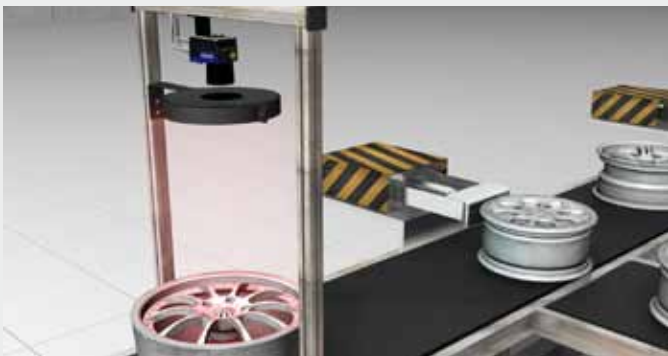

The vision system determines the product model by gross physical characteristics of the inspected rim. In this particular inspection, the key characteristics are the spoke pattern and product diameter. This type of inspection allows for more automation, which in turn, reduces added potential product damage by manual handling and increases the production rates through higher line efficiency.

RIM INSPECTION



This vision system verifies the surface quality and inspects critical dimensions of key features. These inspections reduce any human subjectivity and collect process information that can be used to identify problem areas in the manufacturing line. This captured data is used for further analysis of the process and ultimately problem resolution, reducing costs related to returned products from unsatisfied customers.



RIM ROBOT GUIDANCE



The vision system identifies the position and orientation of the rim to allow the robot to position itself correctly for picking up the rim. This type of guidance prevents damage to the rim due to incorrectly aligned fixtures on the robot.

LABEL INSPECTION



The vision system verifies the printed label matches the current product and ensures the label is readable for transportation and customer identification. This inspection prevents the return of incorrectly labeled parts from the customer and ensures stocking accuracy reducing costs related to miss marked parts.

IMPACT SOFTWARE

Impact Software Suite, with over 120 inspection tools and 50 user interface controls, allows users to create unique inspection programs and develop user interfaces quickly and easily.

All this can be done without the loss of flexibility, like traditional configurable systems, or the need for vast amounts of development time like traditional SDK environments.

VISION PROGRAM MANAGER (VPM)

Vision Program Manager (VPM) provides hundreds of image processing analysis functions. VPM enhance images, locate features, measure objects, check for presence and read text and codes.

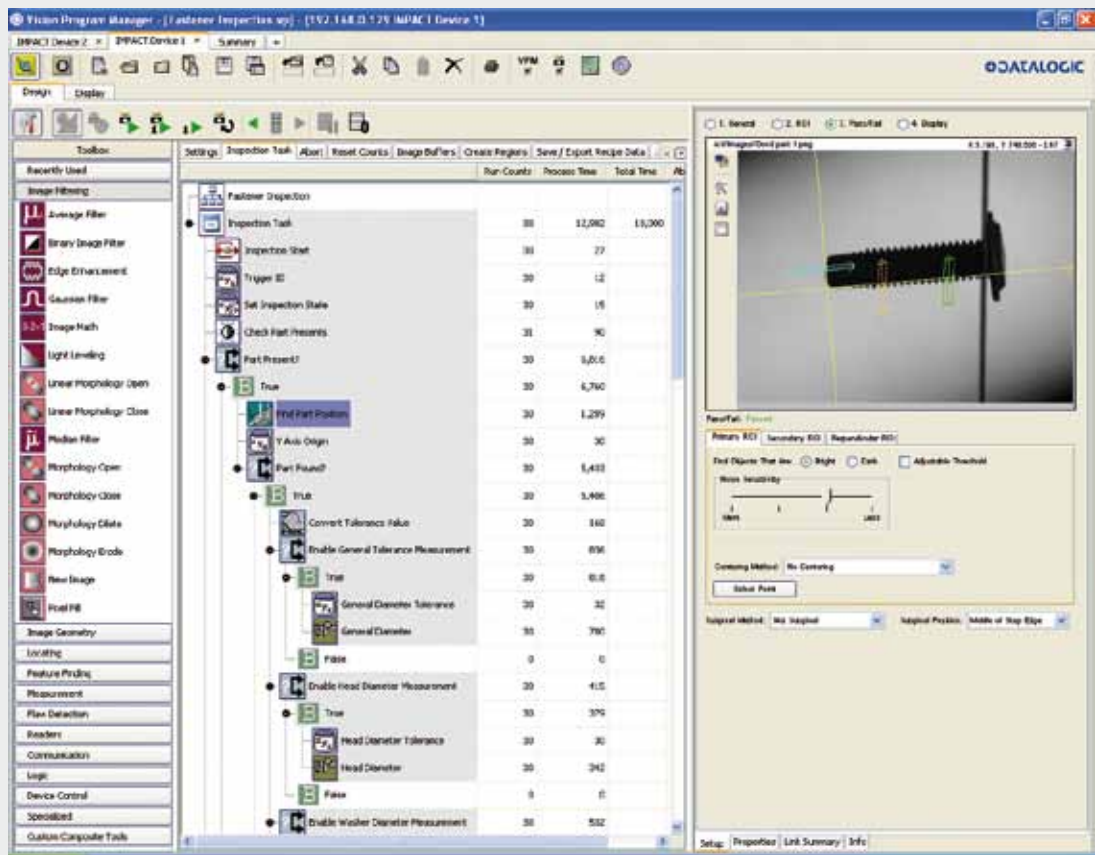

and Use to bar

FEATURES AND BENEFITS

One software fits all

The entire range of smart cameras and vision processors can be configured through the Impact Software suite. Users need only learn one program thus shortening their learning curve. Once developed, the same application can be used on different hardware platforms with no modifications or reprogramming.

Ease-of-use

Impact Software suite is a graphical user interface where no programming is required. Neither VPM nor CPM forces a user to write code. Rather, developers need only to drag-and-drop tools into the tree view and set parameters. Thanks to the embedded emulator, settings can be tested immediately with images previously stored on the PC.

Wide range of controls

With more than 120 controls, Impact is one of the most complete machine vision software suites available on the market. Image filtering, calibration, feature locating, flaw detection, measurement, and code reading are just few examples of the wide range of tools available which allow users to solve even the most challenging applications.

Control Panel Manager (CPM)

Developers can easily create a customized user interfaces thanks to Control Panel Manager (CPM). This software allows users to build up full HMIs just by dragging and dropping controls onto a panel. Authorized operators have the possibility to check images, results and statistics as well as to adjust or modify the working parameters of inspection tasks.

Impact Software powers the full line of integrated vision solutions, from simple to complex. The investment in software and training is preserved as inspections grow. Programs for the same inspections

can be easily shared or transferred across multiple inspection points within the factory.

One software – countless applications!

CONTROL PANEL MANAGER (CPM)

Control Panel Manager (CPM) simplifies development of operator interfaces while providing the ability to make on-the-fly adjustments to critical machine controls. Use CPM to create operator interface panels to view and adjust critical machine controls.

Tolerances (inches)

	Enable	Add in Dist.	Nominal	High	Low	Current	
General Diameter:	<input checked="" type="checkbox"/>		0.500	0.008	0.008	0.170	
Head Diameter:	<input checked="" type="checkbox"/>		1.025	0.020	0.020	0.365	
Washer Diameter:	<input checked="" type="checkbox"/>		0.590	0.020	0.020	0.221	
Head Height:	<input checked="" type="checkbox"/>		1.400	1.420	0.040	0.040	-0.405
Major Diameter:	<input checked="" type="checkbox"/>		0.000	0.025	0.005	0.005	0.222
Minor Diameter:	<input checked="" type="checkbox"/>		0.000	0.530	0.005	0.005	0.186
Spiral Detection:	<input checked="" type="checkbox"/>				0.050	0.000	0.017
Length:	<input checked="" type="checkbox"/>		1.561	2.350	0.020	0.020	-0.297

Setup Parameters | Recipe Manager

Part Present: Max % out of Range: 75.0, % out of Range: 0.0

Peak Valley: Create Regions, Edge Strength: 8.0, 100.0, Minimum Amplitude: 0.012

Spiral Detection Steps: Steps: 1

Test Current Image, Image Buffer Override

ROI Displays

- Part Present ROI
- Origin Setup ROI's Found Origin
- General Measurement ROI
- General Measurement Result
- Head Diameter ROI Head Dia. Result
- Washer Diameter ROI Washer Dia. Result
- Head Height ROI
- Peak / Valley Bounding Region
- View Peak / Valley Search Region's
- View Peak / Valley Points
- Regression Line Segments
- Spiral Detection Results

Unselect All, Select Results

Zoom Percent: 100, 200, 300, 400, 500

Image window: A/0/Images/Good part 1.jpg, X:404.815, Y:162.017 - 173

HIGHLIGHTS

- **Easy to understand**, tree-view logic flow
- Tool Setups guide users through **step-by-step tool configuration**
- Includes **inspection and user interface development programs** as well as a runtime user interface
- Runs on **all smart camera and vision processor platforms**
- Provides **complete programmatic or manual control of hardware settings**
- Provides **real time parameter changes of cameras**
- **Controls and displays images and data** from multiple smart cameras or vision processors
- **Password protection** allows only authorized users to make changes
- **Built-in Emulator** saves time when creating, testing and debugging your vision program without a camera
- Software easily communicates with **higher level control system via TCP/IP, Ethernet/IP, Modbus and OPC protocols.**

TOOLS

FEATURE FINDING

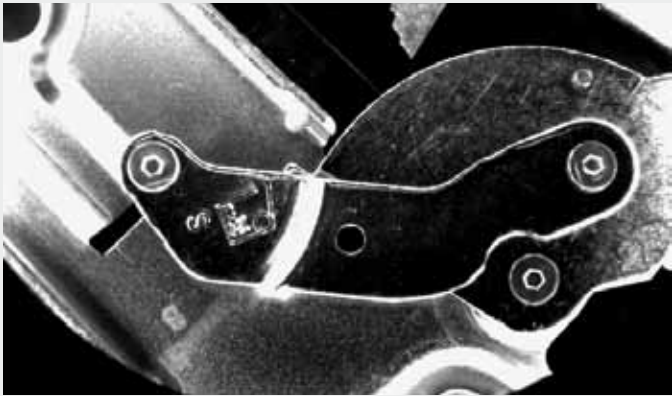

- Detect presence/absence of objects
- Detect randomly oriented or amorphously shaped objects
- Verify whether an object grayscale or color is within acceptable range
- Identify edges of uniformly bright or dark objects
- Determine the sharpness of an edge through the use of gradient

FLAW DETECTION



- Determine if objects are out of range
- Filter objects based on size and shape
- Detect differences between a trained object and run-time objects.
- Detect subtle defects in varying background
- Detect defects along the boundary edge of objects

LOCATE

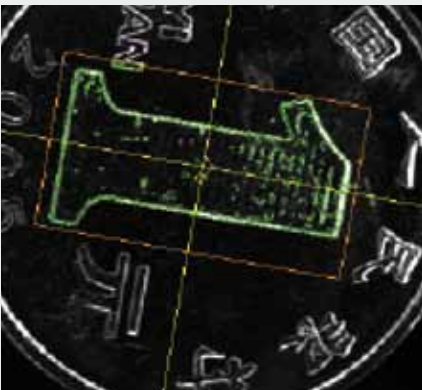

- Use a locate tool to find the object itself or a feature within the object to use as a reference for other tools
- Edge detection to find the corner of an object
- Find the center of mass of an object
- Multiple pattern find tools can be used to find a trained pattern within the image in 360° rotation

IMAGE FILTERING



- A complete set of image filtering tools available:
- Average, Median, Gaussian
 - Morphology open, close, erode, dilate
 - Edge enhancement
 - Binarization
 - Image subtraction
 - Light leveling
 - Pixel fill

COLORS



- Find randomly orientated or amorphously shaped colored objects
- Compare an object color with a trained color
- Color image offers red, green, blue, yellow, magenta, cyan and greyscale formats for use by other tools

MEASUREMENT

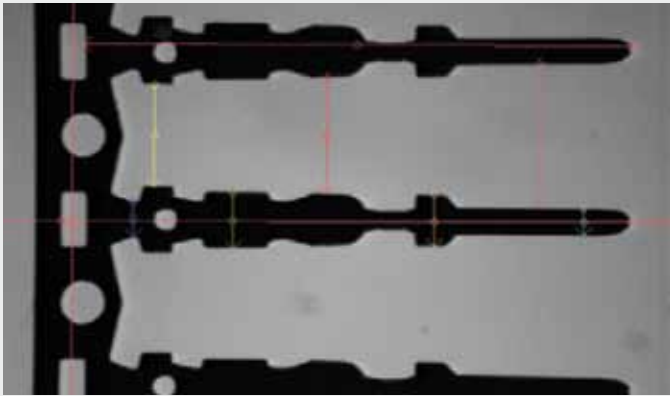

- Pixel or subpixel accuracies are possible
- Measure the angle between to linear objects
- Make multiple measurements within one tool
- Point to point and point to line measurements
- Measure radius, center, and concentricity of circular objects

CODE READERS & OCR



- State of the art 1D and 2D barcode readers. Find multiple codes within one image
- Extremely wide range of code symbologies supported
- Omni-directional code reading
- OCR – Optical Character Recognition – able to read character strings
- OCV – Optical Character Verification – able to verify if the content of a string matches with a trained one

LOGIC PROGRAMMING



- Tree-view programming structure allows for better tool organization and only run tools when requested
- Logic tools allow for decision-making capabilities without scripting
- Perform logical and mathematical calculations in a flexible and easy way

IMAGE CALIBRATION

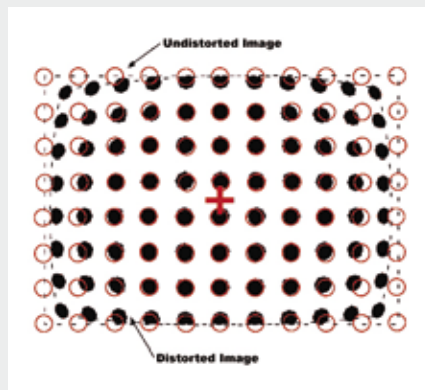

- Allows a user to remove perspective and radial distortion from an image as well as convert pixel to real world values
- Unwrap a curved object or correct a slanted object within an image (primarily used with OCR)
- Combine multiple images into one large image
- Reduce resolution by sampling the image

DATA COMMUNICATION

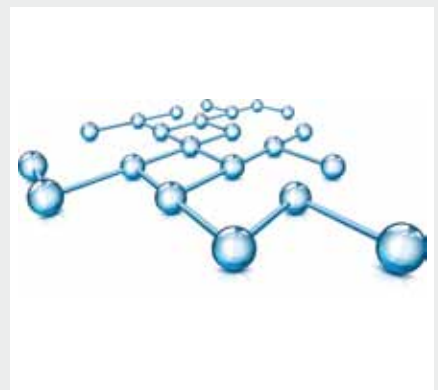

- Discrete I/O, serial, TCP/IP and Ethernet/IP available
- Supports HTTP, FTP and web serving protocols
- ActiveX controls available for 3rd party Microsoft® applications
- Modbus, PCCC and OPC server communication

UNDERSTANDING MACHINE VISION

MACHINE VISION

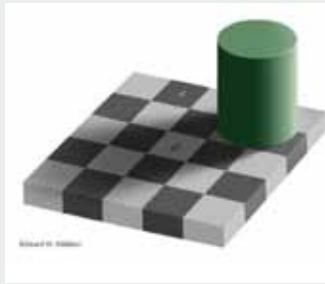

Machine vision is different from human vision. Human brain infers what eyes cannot see. It can create composite images from multiple angles.



A and B squares seem to have different colors (i.e. A darker than B) but actually they do not. By removing surroundings, they have exactly the same greylevel and this is how they are perceived by an electronic eye.

A machine vision monochromatic (greyscale) image will only show differences in contrast. So, a good image for machine vision is different than for human vision.

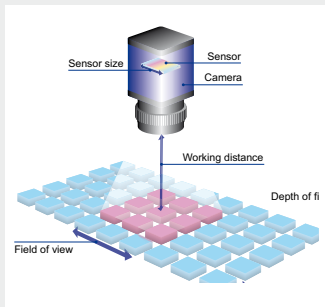

MACHINE VISION GLOSSARY

Working Distance (WD): The distance from the front of the lens to the object when in sharp focus.

Field-of-View (FOV): The imaging area that is projected onto the imager by the lens. Note that most imagers used today provided a 4:3 aspect ratio (4 units wide and 3 units high).

Depth-of-Field (DOF): The range of the lens-to-object distance over which the image will be in sharp focus. Note that the shorter a lens' focal length is, or the more closed a lens' aperture is, the greater the available depth of field.

Resolution: The ability of an optical system to distinguish two features that are close together. Note that both imagers and lenses have their own respective resolutions. Always consider the benefits of better camera resolution, but lens resolution is nearly always better than needed for most factory applications.

CAMERA SELECTION

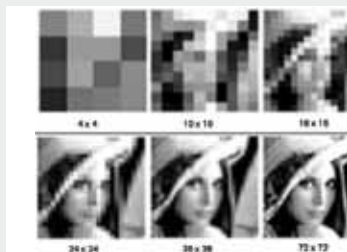

Resolution

Resolution is a measure that identifies the camera capability to acquire image details. Higher resolution means more image detail. The convention is to describe the pixel resolution with the set of two positive integer numbers, where the first number is the number of pixel columns (width) and the second is the number of pixel rows (height), for example as 640 by 480. Another popular convention is to cite resolution as the total number of pixels in the image, typically given as number of megapixels, which can be calculated by multiplying pixel columns by pixel rows.

Acquisition (frame) rate

Frame rate is the frequency (rate) at which a camera is able to acquire consecutive images (area scan camera) or consecutive lines (line scan camera). Frame rate is typically expressed respectively in Frames Per Second (FPS) or Thousands of Line per Second (KHz).

Greyscale VS Color

Most of machine vision applications are solved using greyscale cameras. In a greyscale image the value of each pixel represents the light intensity information. The color depth identifies the number of different intensities (i.e. shades of grey) that can be detected by every image pixel. Color depth is typically expressed in bits or greylevels (e.g. 8 bits = 256 different shades of grey).

8 bit(256 greylevels)	0	26	51	77	102	128	153	179	204	230	255

On the contrary color images contain 24 bits of information per pixel (as opposed to a grayscale's 8 bits), thus giving a color camera 3x more dynamic sensitivity. Note that most color cameras actually use a grayscale imager with a Bayer Filter. Intensity passing through 2x2 pixel grids are interpreted and converted into a color image. Note that there are twice as many green pixels since the human eye is most sensitive to green.



LENS SELECTION

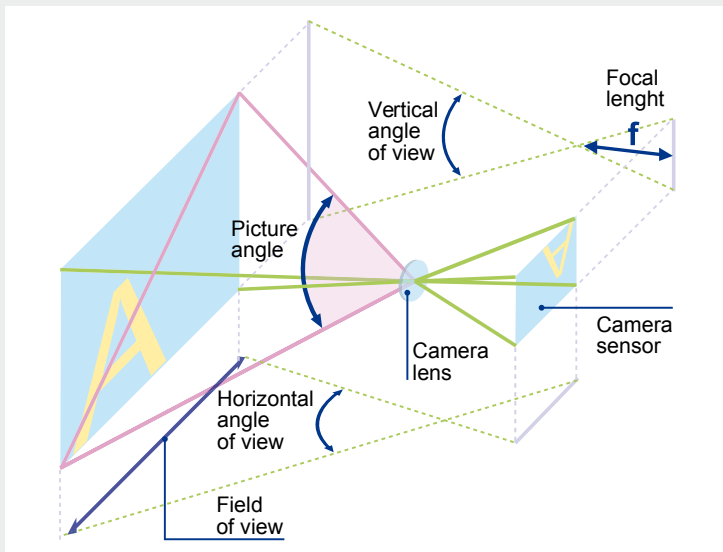

Focal Length:

The focal length of a lens is defined as the distance from the optical center of the converging lens to the focal point, which is located on the imager, when 'in focus'. Units are typically in mm.

Aperture (f-stop):

The ratio of the focal length of the lens to its effective diameter. Shown as f-stop or f/f . Each f-stop would allow either 1/2x or 2x light compare to the next f-stop. A larger aperture opening results in a smaller f-stop value. Note that the more closed a lens' aperture is, the greater the depth of field.

S-MOUNT



S-Mount lenses feature male M12 thread with 0.5 mm pitch on the lens and a corresponding female one the lens mount. Most commonly used with 'remote-head' cameras or with very compact devices like Vision Sensors.

C-MOUNT



C-mount lenses provide a male thread which mates with a female thread on the camera. Most common standard, used with VGA resolution (640x480) up to 2 Megapixel cameras.

F-MOUNT



F-Mount lenses feature a three lug bayonet mount with a 44 mm throat and a flange to focal plane distance of 46.5 mm. Mainly used for high resolution cameras.

CONVENTIONAL VS TELECENTRIC LENSES

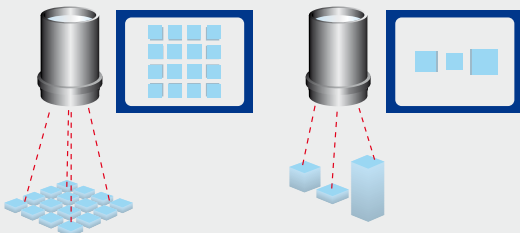

Conventional Lenses view in a conical shape and generally produce magnification errors in radial bands about its center, thus producing magnification errors when viewing objects at different distances.

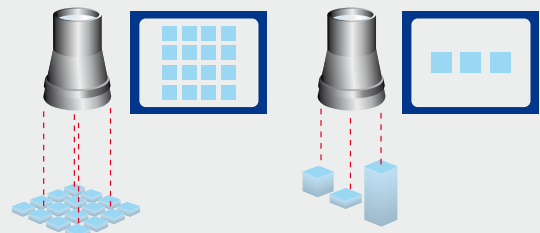

Telecentric Lenses offer constant magnification with change in distance. These lenses are used for high-precision measurement of objects at different depths.

UNDERSTANDING MACHINE VISION

BASIC CONCEPT

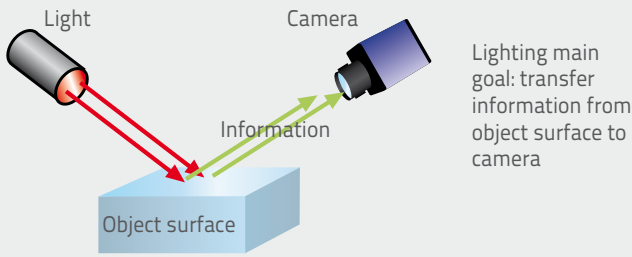

THE IMPORTANCE OF MATERIALS

Material and surface finishing are important as well.



Surface reflectivity difference between the machined aluminum and cast aluminum (direct vs. scattered light)

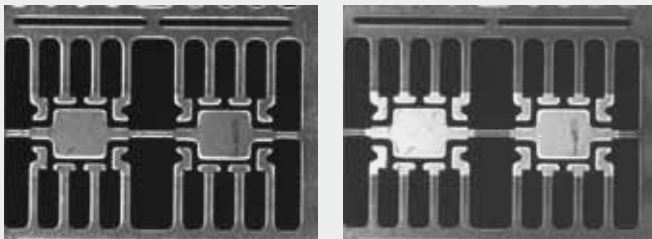

Copper & Silver terminals: red illuminator (on the left), blue illuminator (on the right)

LIGHT INTERACTIONS

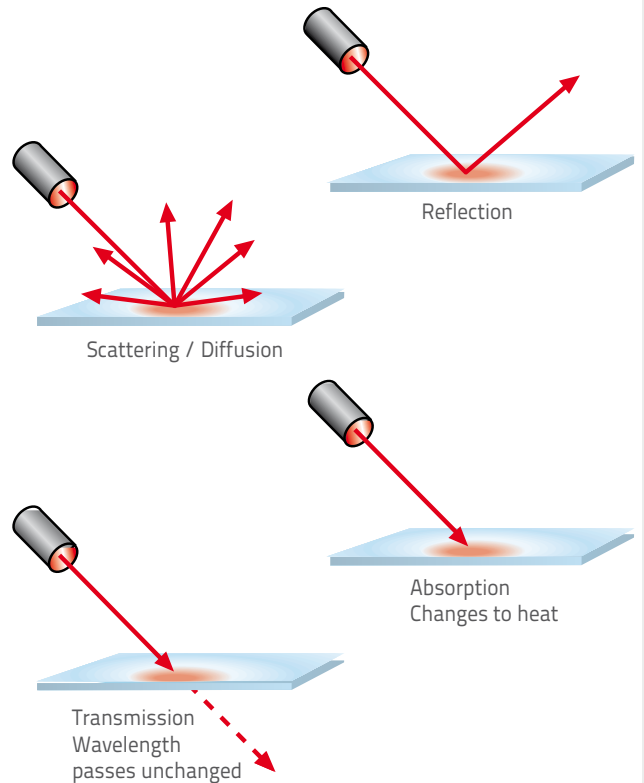

In machine vision the main goal is to optimize the contrast between the features that must be inspected and their background. In order to do so, light interaction principles must be taken into consideration and properly exploited. The characteristics of an object will determine how light is reflected or absorbed.

LIGHTING TECHNIQUES

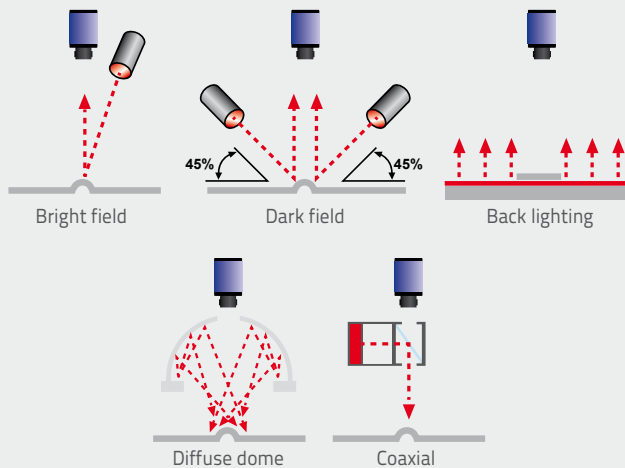

THE IMPORTANCE OF COLORS



Colors affect acquired images even when monochrome cameras are used. Rule of thumb:

- In order to brighten, use same color lighting as compared to the object
- In order to darken, use opposite color lighting as compared to the object

LIGHTING COLOR

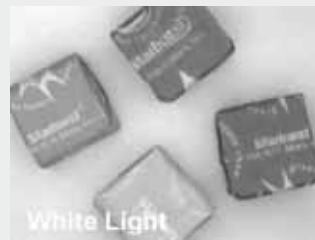

CONSTRAINTS

camera & lens
sharp cut filter R64

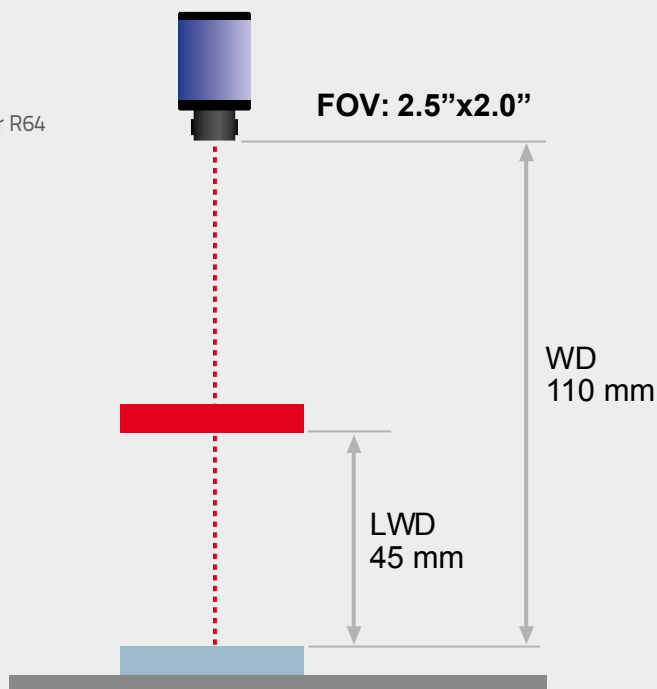

When evaluating a machine vision application, mechanical constraints must be carefully evaluated and considered since they may limit the lighting and lensing solutions.

Space (volume) constraints

- What space is available for lighting?

Speed of inspection

- Limits what lighting (strobed or static) and what inspection tools can be used

Environmental issues

- Specific IP rating requirements?

VISION SENSORS

DATAVS1



- Quick setup without PC
- Fully embedded vision sensor
- 3.5" colour display, 8 push-buttons, 8 LEDs
- 8 different controls
- Memorization of 20 different inspections

The DATAVS1 series is the easiest solution for machine vision applications. The setup is very quick and intuitive thanks to the VSC unit, the external configurator with 3.5" colour display. The sensor setting is carried-out through three simple steps: region of interest definition, control type selection, parameter adjusting. DATAVS1 is a fully embedded vision sensor able to acquire images, control them and activate digital outputs according to the result. The VSC unit can provide a real time monitoring of the images, but it is not required during the functioning of the sensor and so it can be disconnected and used to setup multiple sensors. DATAVS1 is able to carry-out 8 different controls: Brightness, Contrast, Position, Width, Edge counting, Pattern match, Pattern match counting, OCV. Its flexibility together with the VSC configurator make the sensor ideal for plants with frequent format changes (packaging, food, cosmetic, bottling, labelling,...).

DATAVS2



- Flexible and intuitive setup via PC through Ethernet
- Memorization of 20 inspections
- 14 different controls
- Logical operators: AND, OR, NOT, NAND, NOR, etc.
- TURBO mode to double elaboration speed
- VSM compatibility

The DATAVS2 vision sensor series presents all the characteristics able to solve artificial machine vision applications in a flexible and intuitive way. DATAVS2 is a completely embedded device: the optic, the red LED illuminator and electronics are included in an extremely compact housing. The sensor is configured via PC through Ethernet communication. The configuration software is included in the product and it has been developed in order to lead the customer through the configuration process step by step. DATAVS2 is available in four different versions according to the installed control tools: Object Recognition (OBJ), Advanced Object Recognition (AOR), Identification (ID) and Professional (PRO). Many different control typologies are available: brightness, contrast, position, width, count, pattern match, contour match, 360° pattern match, barcode and datamatrix reader, OCV, 360° contour match.

VSM



- 3.5" LCD color display and 8 push buttons
- 20 additional memory slots
- Image and result visualization
- Parameter fine tuning
- DIN rail or panel mounting
- 2 industrial M12 connectors

VSM is a monitoring device compatible with all DataVS2 vision sensor models. The device features a 3.5" LCD color display and 8 push buttons. It also embeds a standard TCP/IP Ethernet interface thus it can be connected either directly to a specific vision sensor or to a LAN where more sensors have been previously installed.

VSM allows to display images and results as well as to change the running inspection or also to adjust the vision sensor functioning parameters.

Thanks to this wide range of functionalities, the device represents an excellent and complete HMI interface ideal for automated production lines attended by operators.

VISION SENSORS



DataVS1

DataVS2

CMOS 8-bit gray-scale, 60 fps

CMOS 8-bit gray-scale, 60 fps

640 x 480 (VGA)

640 x 480 (VGA)

Integrated (RED)

Integrated (RED)

Integrated S-Mount
(6, 8, 12, 16 mm)

Integrated S-Mount
(6, 8, 12, 16 mm)

Configuration through Vision Sensor Configurator (VSC).
No PC needed.

Configuration through PC
(the DataVS2 Graphical User Interface software is supplied with the product)

Basic

Basic (OBJ)
Advanced (AOR)
Identification (ID)
Professional (PRO)

Up to 20 inspections

Up to 20 inspections

2 IN (trigger, inspection selection)
4 OUT

OBJ and AOR models
2 IN (trigger, inspection selection)
4 OUT

ID and PRO models
1 IN (trigger)
3 OUT

NETWORK INTERFACE

10/100 Mbps Ethernet

SERIAL COMMUNICATIONS

RS232 (ID and PRO models)

VSC COMPATIBILITY

▪

VSM COMPATIBILITY

▪

CONNECTORS

2 x M12 8-pole

M12 8-pole (Power Supply + I/Os)
M12 4-pole (Ethernet)

SUPPLY VOLTAGE

24 Vdc ± 10%

24 Vdc ± 10%

CURRENT DRAW WITH ILLUMINATOR

Max 200 mA @ 24 Vdc

Max 200 mA @ 24 Vdc

DIMENSIONS

70 x 52 x 40 mm
(2.76 x 2.05 x 1.57 in)

70 x 52 x 40 mm
(2.76 x 2.05 x 1.57 in)

OPERATING TEMPERATURE

-10 °C ... +55 °C

-10 °C ... +55 °C

MECHANICAL PROTECTION

IP50

IP50

CERTIFICATIONS
(SAFETY COMPLIANCE)

CE, UL

CE, UL

SMART CAMERAS

A20



- Cost effective Smart Camera series
- Right-angle format
- WVGA (752x484) grey-scale imager
- Built-in digital I/Os and Serial interface
- 10/100 Ethernet Port

The A20 smart camera provides the perfect balance of size, functionality and pricing to easily support a wide multitude of tasks ranging from simple quality controls to complex machine vision inspections. The A20 Smart Cameras features a WVGA 1/3" greyscale imager, discrete I/Os, Serial and Ethernet interfaces thus representing a fully embedded stand-alone device able to offer high return on investment solutions.

A30



- Cost effective Smart Camera series
- Right-angle IP67 rated enclosure
- VGA (640x480) grey-scale imager
- Built-in digital I/Os and Serial interface
- Gbit Ethernet Port

The A30 Series is a stand-alone, general purpose and cost effective Smart Camera that can be installed even in harsh industrial environments thanks to its IP67 rated housing. The A30 Series features a VGA (640x480) CCD imager, built-in discrete I/Os as well as Ethernet and Serial interfaces. Thanks to the ultimate programming flexibility offered by Impact software, the A30 Series represents the answer to every machine vision need.

T2x



- Mid performance Smart Camera series
- In-line or Right-angle formats
- Up to 2Mpix grey-scale or color imager
- Built-in digital I/Os and Serial interface
- 10/100 Ethernet Port

The T2x Series smart camera products are stand-alone, general purpose, industrialized machine vision inspection systems that allow for incredible flexibility in programming through the Impact software. With models ranging from standard VGA resolution up to 2 Megapixels, the T2x Series smart cameras can deliver the right solution for your general-purpose machine vision needs or specific application inspection requirements.

T4x



- High performance Smart Camera series
- Right-angle IP67 rated enclosure
- Up to 5Mpix grey-scale imager
- Built-in digital I/Os and Serial interface
- Gbit Ethernet Port

The new T4x-Series smart camera provides customers with outstanding performance in an industrialized and compact package. Equipped with a powerful 1.1 GHz processor, the T4x-Series performance is exceptional in value and functionality. The T-Series comes in 3 different camera resolutions, VGA, 2 Mega-Pixel and 5 Mega-Pixel all in a sealed, industrially hardened enclosure for maximum protection. Combined with Impact software, the new generation T-series delivers the most rugged and versatile smart camera solution in the market today.

SMART CAMERAS



	A20	A30	T2x	T4x
FORMAT	Right angle	Right angle	Right angle In line	Right angle
IMAGER	<ul style="list-style-type: none"> 752 x 484, 1/3" CMOS, 60 fps 	<ul style="list-style-type: none"> 640 x 480, 1/3" CCD, 60 fps 	<ul style="list-style-type: none"> 640 x 480, 1/3" CCD, 60 fps 1024 x 768, 1/3" CCD, 16 fps 1600 x 1200, 1/1.8" CCD, 12 fps 	<ul style="list-style-type: none"> 640 x 480, 1/3" CCD, 60 fps 1600 x 1200, 1/1.8" CCD, 15 fps 2448 x 2048, 2/3" CCD, 15 fps
IMAGE	8-bit gray-scale	8-bit gray-scale	8-bit gray-scale 24-bit color	8-bit gray-scale
LENS MOUNT	C-Mount	C-Mount	C-Mount	C-Mount
PROCESSOR	667 MHz Power PC	800 MHz DaVinci	667 MHz Power PC	1.1 GHz DaVinci
ON-BOARD IMAGE BUFFERING	Up to 46	Up to 16	Up to 54 @ VGA resolution	Up to 16
ON-BOARD PROGRAM STORAGE	512 MB flash	256 MB flash	512 MB flash	256 MB flash
DEDICATED ON-BOARD OPTICALLY ISOLATED I/O	1 IN / 1 OUT	1 IN / 1 OUT	1 IN / 1 OUT	1 IN / 1 OUT
CONFIGURABLE ON-BOARD OPTICALLY ISOLATED I/O	2 IN / 4 OUT	1 IN / 2 OUT	2 IN / 3 OUT	1 IN / 2 OUT
RS-232 SERIAL	▪	▪	▪	▪
ETHERNET	▪	▪	▪	▪
EXTERNAL BUTTON		▪		▪
POWER REQUIRED	24 VDC 0.5A	10 ... 30 VDC 1 ... 0.33 A	24 VDC 0.5 A	<ul style="list-style-type: none"> T40 10 ... 30 VDC 1 ... 0.33 A T47 10 ... 30 VDC 1.05 ... 0.35 A T49 10 ... 30 VDC 1.2 ... 0.4 A
DIMENSIONS	140 x 68 x 24 mm (5.5 x 2.68 x 0.94 in)	123 x 60 x 86 mm (4.84 x 2.36 x 3.41 in)	<ul style="list-style-type: none"> In-line: 138 x 63 x 45 mm (5.43 x 2.5 x 1.75 in) Right-angle: 127 x 76 x 66 mm (5 x 3 x 2.54 in) 	123 x 60 x 101 mm (4.84 x 2.36 x 3.98 in)
MECHANICAL PROTECTION	-	IP67	-	IP67
OPERATING TEMPERATURE	0 °C ... +50 °C	0 °C ... +45 °C	-5 °C ... +45 °C	0 °C ... +50 °C
HUMIDITY (NON-CONDENSING)	20 ... 80 %	0 ... 90 %	20 ... 80 %	0 ... 90 %
CERTIFICATIONS	CE, UL	CE, CSA	CE, UL	CE, CSA

VISION PROCESSORS

MX20



- Cost effective Vision Processor
- Intel® T3100 dual-core 1.90 GHz processor
- Up to two 2 Mpix cameras connected
- Win XP® or Win 7® operating systems

The MX20 Series is an entry-level, affordable processor. This rugged, compact model features an Intel® T3100 dual-core 1.90 GHz processor and two independent PoE (Power over Ethernet) camera ports. The MX20 is easy to deploy, supporting up to two 2.0 Megapixel area scan cameras for a wide range of flexible, robust inspection tasks. The MX20 offers a cost-effective mean to migrate from smart-camera applications to an embedded vision system.

MX40



- Mid performance Vision Processor
- Intel® P8400 dual-core 2.26 GHz processor
- Up to four cameras connected
- Win XP® or Win 7® operating systems

The MX40 Series is a ruggedized and compact embedded vision processor that features Intel® multi-core processors and four independent PoE (Power over Ethernet) camera ports. The MX40's long-life embedded components provide a very robust and reliable vision system for critical inspection applications. The MX40 eliminates the need to purchase and install multiple cameras thus saving additional costs and reducing setup and networking time.

MX80



- High performance Vision Processor
- Intel® Core™ i7 quad-core processor
- Up to four cameras connected
- Win XP® or Win 7® operating systems

The next-generation MX80 Vision Processor extends the power and performance of MX-Series to faster applications, advanced algorithms and higher-resolutions. The MX80, with its Intel® Core™ i7 quad-core microprocessor, 4GB memory and four independent Gigabit PoE (Power over Ethernet) ports provides more image processing speed and power for up to four unique MX-Series camera inspections running parallel.

VISION PROCESSORS



	MX20	MX40	MX80
CPU	Intel® T3100 dual-core 1.90 GHz	Intel® P8400 dual-core 2.26 GHz	Intel® Core i7-2710QE 4-core 2.10 GHz
SYSTEM MEMORY	4 GB DDR3 RAM	4 GB DDR3 RAM	4 GB DDR3 RAM
STORAGE	40 GB SSD	40 GB SSD	40 GB SSD
GRAPHICS	Intel® GM45/ICH9 video chipset (1600 x 1200 resolution), VGA	Intel® GM45/ICH9 video chipset (1600 x 1200 resolution), VGA	Intel® QM67 Express chipset (2048 x 1536 resolution), DVI
CAMERA INTERFACE	2-1000 Mbps Base-T, PoE camera ports (up to 7 W per channel)	4-1000 Mbps Base-T, PoE camera ports (up to 7 W per channel)	4-1000 Mbps Base-T, PoE camera ports (up to 7 W per channel)
CAMERA IMAGER LIMIT	2Mpixel or lower No LineScan support	None	None
NETWORK INTERFACE	2-10/100/1000 Mbps Base-T, LAN ports	2-10/100/1000 Mbps Base-T, LAN ports	2-10/100/1000 Mbps Base-T, LAN ports
SERIAL COMMUNICATIONS	2-RS-232 serial ports	2-RS-232 serial ports	5-RS-232 serial ports
USB	3-USB 2.0 ports	3-USB 2.0 ports	4-USB 2.0 ports 2-USB 3.0 ports
KEYBOARD/MOUSE	Combined PS/2 type mini-DIN connectors	Combined PS/2 type mini-DIN connectors	Combined PS/2 type mini-DIN connectors
COMM CONNECTIVITY	Supports Ethernet/IP, Modbus TCP and OPC	Supports Ethernet/IP, Modbus TCP and OPC	Supports Ethernet/IP, Modbus TCP and OPC
I/O	16 isolated digital inputs 16 isolated digital outputs 2 event inputs (shared with the Polled Inputs)	16 isolated digital inputs 16 isolated digital outputs 2 event inputs (shared with the Polled Inputs)	16 isolated digital inputs 16 isolated digital outputs 2 event inputs (shared with the Polled Inputs)
OPERATING SYSTEM	Windows XP Pro 32-Bit Windows 7 Pro 64-Bit	Windows XP Pro 32-Bit Windows 7 Pro 64-Bit	Windows XP Pro 32-Bit Windows 7 Pro 64-Bit
POWER REQUIREMENTS	24 VDC (+/- 10%, 3.5 amp min)	24 VDC (+/- 10%, 3.5 amp min)	24 VDC (+/- 10%, 4.5 amp min)
DIMENSIONS	200 mm x 85 mm x 165 mm (7.8 in. x 3.3 in. x 6.5 in)	200 mm x 85 mm x 165 mm (7.8 in. x 3.3 in. x 6.5 in)	230 mm x 82 mm x 206 mm (9.06 in. x 3.23 in. x 8.11 in)
OPERATING TEMPERATURE	0 to 55° C (+32 to +131° F)	0 to 55° C (+32 to +131° F)	0 to 55° C (+32 to +131° F)
HUMIDITY	0 to 90% (non-condensing)	0 to 90% (non-condensing)	0 to 90% (non-condensing)
CERTIFICATIONS (SAFETY COMPLIANCE)	CE/FCC, RoHS, UL	CE/FCC, RoHS, UL	CE/FCC, RoHS, UL

DIGITAL CAMERAS

MX-SERIES CAMERAS

MX-Series cameras enable fast integration of challenging machine vision solutions. The unique ability to mix and match color, gray-scale and line scan cameras with an MX-Series

processor lets the user define, select and deploy a solution for high-speed, multi-camera machine vision inspections.

MX-SERIES GIG-E CAMERAS

	GRAY-SCALE MODEL	COLOR MODEL	RIGHT ANGLE	RESOLUTION	IMAGER	FRAME RATE (FPS)	DIMENSIONS*
	M100	M100C		640 x 480	1/4" CCD	100	29 x 29 x 60.3 mm (1.14 x 1.14 x 2.37 in)
	M110	M110C		640 x 480	1/3" CCD	90	
	M115	M115C		659 x 494	1/2" CCD	100	
	M125	M125C		782 x 582	1/2" CCD	75	
	M150	M150C		1296 x 966	1/3" CCD	30	
	M180	M180C		1628 x 1236	1/1.8" CCD	20	
	M190	M190C		2048 x 1088	2/3" CMOS	50	
M195	M195C		2048 x 2048	1"	25		
	M200	M200C	▪	659 x 494	1/3" CCD	70	44 x 29 x 85.5 mm (1.73 x 1.14 x 3.37 in)
	M202	M202C	▪	659 x 494	1/2" CCD	79	
	M205	M205C	▪	752 x 480	1/3" CMOS	64	
	M210	M210C	▪	782 x 582	1/2" CCD	55	
	M230	M230C	▪	1034 x 779	1/3" CCD	31	
	M250	M250C	▪	1280 x 960	1/3" CCD	32	
	M270	M270C	▪	1392 x 1040	2/3" CCD	30	
	M290	M290C	▪	1628 x 1236	1/1.8" CCD	14	
M295	M295C	▪	1628 x 1236	1/1.8" CCD	28		
	M300	M300C	▪	648 x 488	1/3" CCD	210	44 x 29 x 98.5 mm (1.73 x 1.14 x 3.88 in)
	M330	M330C	▪	1004 x 1004	2/3" CCD	60	
	M350	M350C	▪	1608 x 1208	1" CCD	35	
	M390	M390C	▪	2448 x 2050	2/3" CCD	17	

*in-line models

MX-SERIES LINE-SCAN GIG-E CAMERAS

	MODEL	RESOLUTION	MAX. LINE RATE	IMAGER SIZE	C-MOUNT	F-MOUNT
	M510	1024	18.7 KHz	10.24 mm	▪	▪
	M520	1024	35.7 KHz	10.24 mm	▪	▪
	M530	1024	56.1 KHz	10.24 mm	▪	▪
	M540	2048	9.7 KHz	20.48 mm	▪	▪
	M550	2048	18.7 KHz	20.48 mm	▪	▪
	M560	2048	29.2 KHz	20.48 mm	▪	▪

MX-SERIES SPECIALTY CAMERAS

MX-Series specialty cameras support today's complex vision requirements that call for high-speed, high-quality inspections and measurements. These GigE Vision-compliant models represent

the industry's latest advances in camera technologies, powered by Impact Software and supported globally by exceptional engineering expertise and customer service.

MX-SERIES SPECIALTY GIG-E CAMERAS

MODEL	RESOLUTION	IMAGER	MONOCHROME/COLOR	ACQUISITION RATE	LENS MOUNT
JAI					
Remote Head	656 x 494	1/3" CCD	Monochrome	120 fps	C-Mount
UV Sensitive	1380 x 1040	1/2" CCD	Monochrome	16 fps	C-Mount
8 MegaPixel	3296 x 2472	4/3" CCD	Monochrome	10 fps	F-Mount
16 MegaPixel	4872 x 3248	43.3mm CCD	Monochrome	3 fps	F-Mount
3 CCD Color	1392 x 1040	1/2" CCD	Color	20 fps	C-Mount
3 CCD Color	XZ1620 x 1236	1/1.8" CCD	Color	15 fps	C-Mount
BASLER					
Aviator	1K x 1K	1/2" CCD	Monochrome - Color	100 fps	C-Mount
Aviator	1600 x 1200	2/3" CCD	Monochrome - Color	50 fps	C-Mount
Aviator	1920 x 1080	2/3" CCD	Monochrome - Color	50 fps	C-Mount
Aviator	2330 x 1750	1" CCD	Monochrome - Color	25 fps	C-Mount
SVS-VISTEK					
IP67	640 x 480	1/3" CCD	Monochrome - Color	124 fps	C-Mount
IP67	640 x 480	1/2" CCD	Monochrome - Color	125 fps	C-Mount
IP67	640 x 480	1/4" CCD	Monochrome - Color	150 fps	C-Mount
IP67	780 x 580	1/2" CCD	Monochrome - Color	86 fps	C-Mount
IP67	1024 x 768	1/3" CCD	Monochrome - Color	47 fps	C-Mount
IP67	1280 x 960	1/3" CCD	Monochrome - Color	30 fps	C-Mount
IP67	1360 x 1024	1/2" CCD	Monochrome - Color	25 fps	C-Mount
IP67	1360 x 1024	2/3" CCD	Monochrome - Color	34 fps	C-Mount
IP67	1600 x 1200	1/1.8" CCD	Monochrome - Color	26 fps	C-Mount
IP67	2448 x 2050	2/3" CCD	Monochrome - Color	10 fps	C-Mount
TELEDYNE DALSA					
Linescan	1K	Linear Imager	Monochrome	36 KHz	C-Mount F-Mount
Linescan	1K	Linear Imager	Monochrome	68 KHz	C-Mount F-Mount
Linescan	2K	Linear Imager	Monochrome	18 KHz	C-Mount F-Mount
Linescan	2K	Linear Imager	Monochrome	36 KHz	C-Mount F-Mount
Linescan	4K	Linear Imager	Monochrome	18 KHz	F-Mount

ACCESSORIES



OPTICS AND FILTERS



ILLUMINATORS

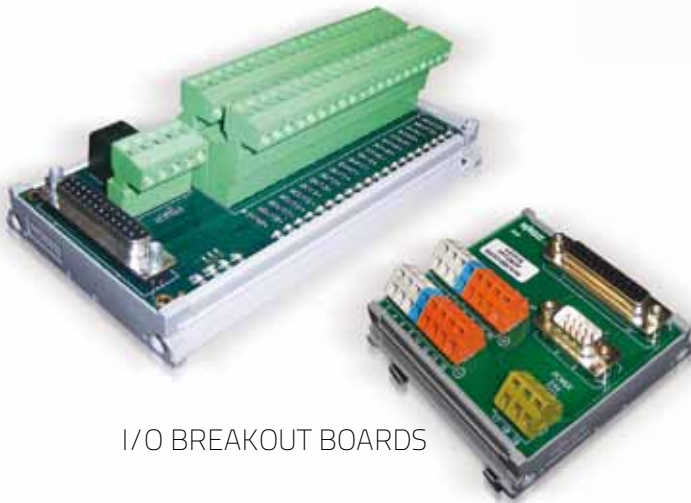

I/O BREAKOUT BOARDS



OTHER ACCESSORIES

Datalogic Automation is able to provide a broad and comprehensive range of accessories to allow customers and partners to fully leverage the power and capabilities of its machine vision systems. A wide and complete portfolio of lenses, filters, illuminators, enclosures, breakout boards, etc... either designed and manufactured internally or coming from selected leading machine vision suppliers.

OPTICS AND FILTERS

- Standard, flat field and telecentric lenses available in C-Mount and F-Mount formats
- Lens filters

I/O BREAKOUT BOARDS

- Standard I/O boards
- Expansion I/O boards
- Connectivity to industrial fieldbus

ILLUMINATORS

- Different technologies such as LED, fluorescent, xenon, halogen, laser, etc...
- Different colors, formats and shapes
- Backlighting, bright-field and dark-field illuminators

OTHER ACCESSORIES

- Camera enclosures
- Industrial monitors
- Cables
- Mounting hardware

TRAINING & SUPPORT

WWW.DATALOGIC.COM

- FREE full-feature trial software
- FREE download product literature, technical specifications and drawings
- FREE online training material to do at your own pace
- FREE IMPACT application videos and sample programs
- FREE MV initial application evaluation



BASIC - 1.5 DAYS

- What is machine vision
- Vision products overview
- Application examples and proven solutions
- DataVS training
- I/O wiring of the hardware - basics
- VPM basic training

INTERMEDIATE - 2 DAYS

- VPM intermediate training
- CPM basic training.
- Application Specific training – attendees are requested to bring their parts to work on them

ON-SITE TRAINING

- Customized for Your Application, Location and Schedule
- Contact our Training Department for pricing

SUPPORT

- Phone support Mon to Fri, 8 to 5
- Email support – contact Datalogic Automation Application Engineering dept. at mvsupport@datalogic.com
- Complete Turn-key solutions with:
 - a. In-depth application evaluations
 - b. VPM and CPM programming
 - c. On-site installations

HEADQUARTERS

Datalogic Automation Srl

Via Lavino, 265
40050 Monte San Pietro - Bologna - Italy
Tel. +39 051/6765611
Fax +39 051/6759324
info.automation.it@datalogic.com

BRANCHES AND SALES OFFICES

EUROPE

BENELUX

Datalogic Automation Benelux

Newtonweg 3
4104 BK Culemborg
The Netherlands
Tel. +31 345/589489
Fax +31 345/511419
info.automation.nl@datalogic.com

FRANCE

Datalogic Automation Srl

Succursale en France
Le Parc Technologique de Lyon
333 cours du 3ème Millénaire - Le Pôle
69800 Saint Priest
Tél. +33 (0)4/72476180
Fax +33 (0)4/72470721
info.automation.fr@datalogic.com

GERMANY

Datalogic Automation Srl

Niederlassung Central Europe
Carl-Zeiss Str. 31
73230 Kirchheim/Teck
Tel. +49 (0)7021/509700
Fax +49 (0)7021/5097029
info.automation.de@datalogic.com

ITALY

Datalogic Automation Srl

Via Lavino, 265
40050 Monte San Pietro - Bologna
Tel. +39 051/6765611
Fax +39 051/6759324
info.automation.it@datalogic.com

Datalogic Automation Srl

LASER MARKING

Via Le Gorrey, 10
11020, Donnas - Aosta
Tel. +39-0125-8128201
Fax +39-0125-8128401
info.automation.it@datalogic.com

Via Dell'Industria 20, 21018
Sesto Calende - Varese
Tel. +39-03319180601
Fax +39-03319180801
info.automation.it@datalogic.com

SPAIN

Datalogic Automation Iberia

Sucursal en España
C/Samontà, 21 Planta baja, Local O
08970 Sant Joan Despí - Barcelona
Tel. +34 (0)93/4772059
Fax +34 (0)93/4777272
info.automation.es@datalogic.com

NORDIC

Datalogic Automation AB

Höjdrodergatan 21
21239 Malmö - Sweden
Tel. +46 (0)40/385000
Fax +46 (0)40/385001
info.automation.se@datalogic.com

UNITED KINGDOM

Datalogic Automation UK

Datalogic House
Dunstable Road, Redbourn - Hertfordshire
AL3 7PR
Tel. +44 (0) 1582 791750
Fax +44 (0) 1582 791769
info.automation.uk@datalogic.com

NORTH AMERICA

Datalogic Automation Inc

511 School House Road
Telford, PA 18969-1196 - United States
Tel. +1-800-BAR-CODE or +1-215-723-0981
Fax +1-215-721-5551
info.automation.us@datalogic.com

Datalogic Automation Inc

MACHINE VISION

5775 W Old Shakopee Rd
STE 160, Bloomington, MN 55437
United States
Tel. +1-952-996-9500
Fax +1-952-996-9501
info.automation.us@datalogic.com

APAC

AUSTRALIA-NEW ZEALAND

Datalogic Automation Pty Ltd

Unit 130, 45 Gilby Road
Mt Waverley - Victoria, 3149 - Australia
Tel. +61 (0)3/95589299
Fax: +61 (0)3/95589233
info.automation.au@datalogic.com

CHINA

Datalogic Automation Asia

Floor 20, Room 2017, Building 2,
16 West Nan San Huan Road
Fengtai District, Beijing
Tel: +86 (0)21-5836 6692
Fax: +86 (0)21-5836 6695
info.automation.cn@datalogic.com

Suite 1301, Hua Rong Plaza,
1289 South Pudong Road, Pudong District
Shanghai 200120
Tel: +86 (0)21-5836 6692
Fax: +86 (0)21-5836 6695
info.automation.cn@datalogic.com

Room 1104B, 5#Tower, Fantasta MIC Plaza,
West Nanhai Road, Nanshan District,
518054 Shenzhen, Guangdong, China
Tel: +86 (0)755-8629 6779
Fax: +86 (0)755-8628 1280
info.automation.cn@datalogic.com

JAPAN

Idec Datalogic Co. Ltd

10-40, Mikuni-Honmachi 1-Chome,
Yodogawa-ku, Osaka 532 0005
Tel. +81(6) 6398/3200
Fax +81 (6) 6398/3202
www.idljp.com

Rev. 04, 11/2013



9C512100U



Product and Company names and logos referenced may be either trademarks or registered trademarks of their respective companies. We reserve the right to make modifications and improvements.



DATALOGIC

www.datalogic.com