

PIPE SEALS - HIGH PRESSURE BOOT
 TANK SEAL - FEDERAL SPEC. ASTM C990
 CONCRETE - STEEL REINFORCED
 - 28 DAY 6100 PSI

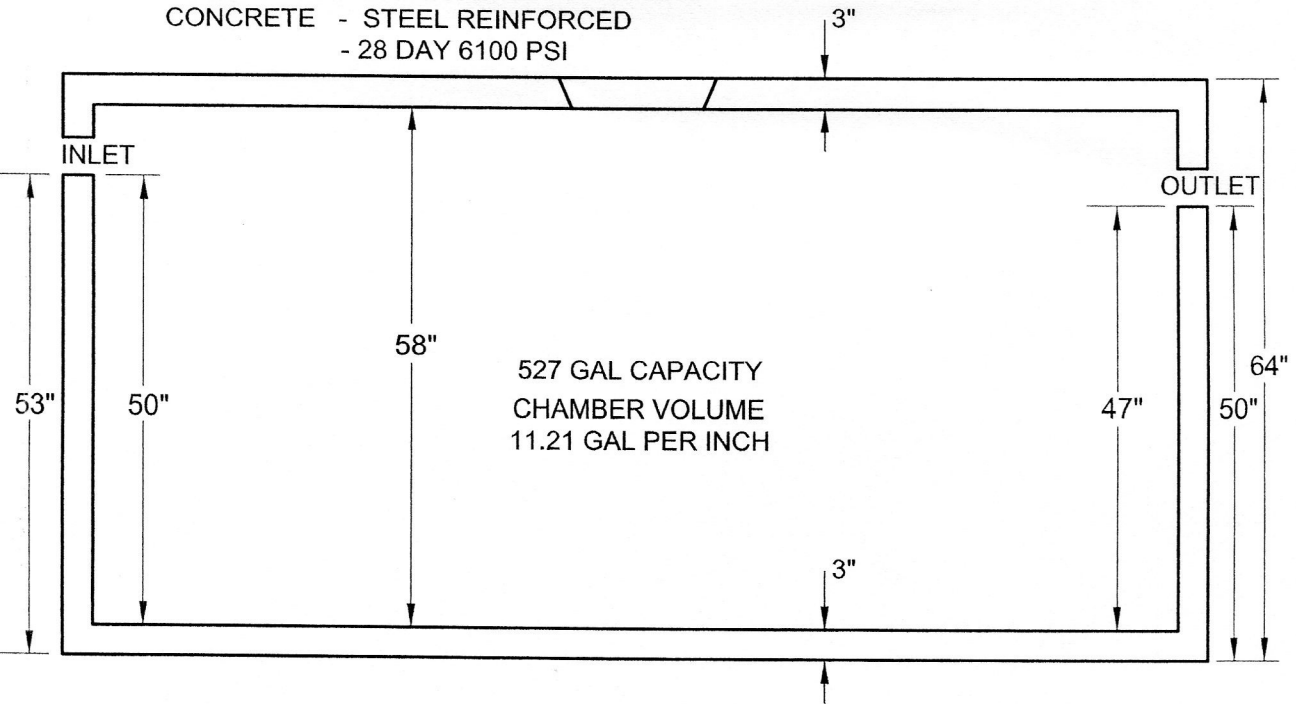

Concrete 500 gal. Pump Tank

Lycoming, A division of Lycoming Burial Vault Co., Inc.

350 Spruce Street Montoursville, PA 17754

Phone: (570) 368-8642 Toll Free: (800) 640-0052 Fax: (570) 368-2299



Drawn by: Wentz & Webster Engineering 11/21/08