

B&L
persianas
INTERIOR & EXTERIOR



CATÁLOGO
AS EN TU
SUPERFICIES



SUPERFICIES INSPIRADORAS PARA VIVIR

COSENTINO CREA ESPACIOS CONTEMPORÁNEOS Y ACTUALES CON LA ELEGANCIA DE LA PIEDRA NATURAL CON MATERIALES LUJOSOS Y PRECIOSOS.



B&L
persianas

INTERIOR & EXTERIOR



SILESTONE

90% CUARZO NATURAL

- REQUIERE POCO MANTENIMIENTO, ALTA RESISTENCIA AL IMPACTO, MANCHAS, RAYADO Y AL ÁCIDO
- EPUEDE USARSE EN PIEZAS GRANDES SIN REQUERIR JUNTAS
- MÁS DE 50 COLORES CON DIFERENTES TEXTURAS, BORDES Y FORMATOS
- USOS SUGERIDOS:



COCINA



REVESTIMIENTOS



BAÑOS



PISOS



SILESTONE

TEXTURAS



SUEDE



VOLCANO



PULIDO



POLISHED N-BOOST



SUEDE N-BOOST



MATTE



SUEDE

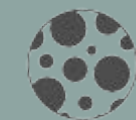

VOLCANO



SILESTONE

MEDIDAS DISPONIBLES



MEDIDAS TABLA:
ESTÁNDAR: 306 x 140 cm
JUMBO: 325 x 159 cm

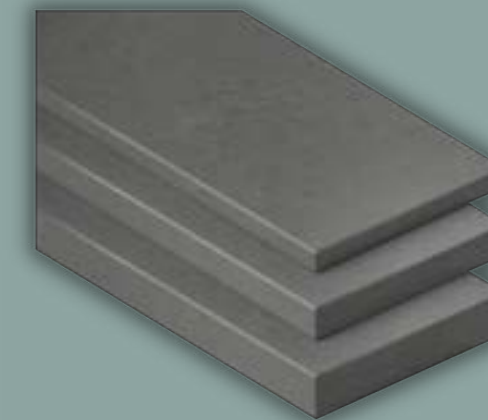

ESPESOR TABLA:
1.2 CM
2 CM
3 CM

MEDIDAS PISOS Y REVESTIMIENTOS: 30X30 CM;
60X30 CM; 60X40 CM; 40X40 CM; 60X60 CM

ESPESOR PISOS Y REVESTIMIENTOS: 1.2 CM; 2 CM

SILESTONE ETHEREAL

HYBRIQ⁺
TECHNOLOGY[®]



ETHEREAL HAZE



DUSK



HAZE



GLOW

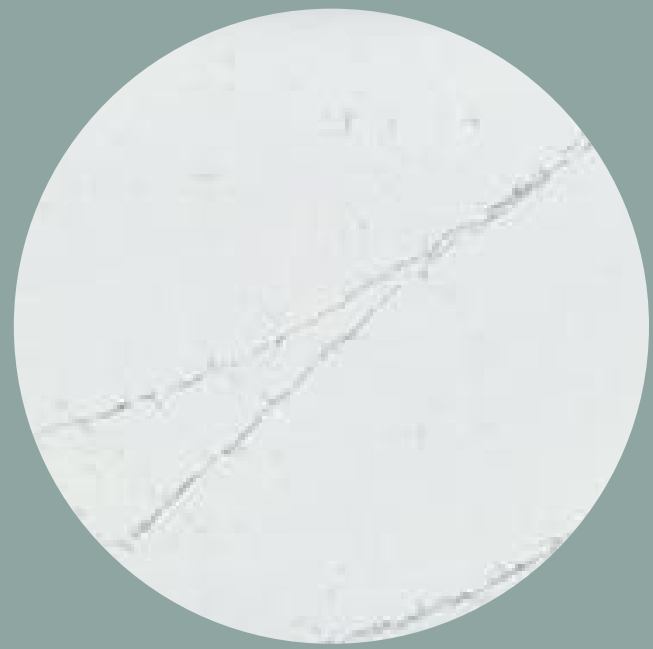

NOCTIS



CORKTOWN



NOLITA



POBLENOU



CAMDEN



SEAPORT



CORKTOWN

 silestone®

HYBRIQ+

TECHNOLOGY

SILESTONE

TECNOLOGÍA HYBRIQ

- DISPONIBLE EN LAS COLECCIONES ETHEREAL Y LOFT
- SUPERFICIE HÍBRIDA BASADA EN MINERALES Y VIDRIO RECICLADO
- UTILIZA ENERGÍA 100% RENOVABLE
- 98% DE AGUA RECICLADA
- MÍNIMO DEL 20% DE MATERIAL RECICLADO (VIDRIO)
- MÁS BELLEZA, MÁS SOSTENIBLE, MENOR IMPACTO

SILESTONE SUNLIT DAYS



POSIDONIA GREEN



FARO WHITE



CINCEL GRAY



POSIDONIA GREEN

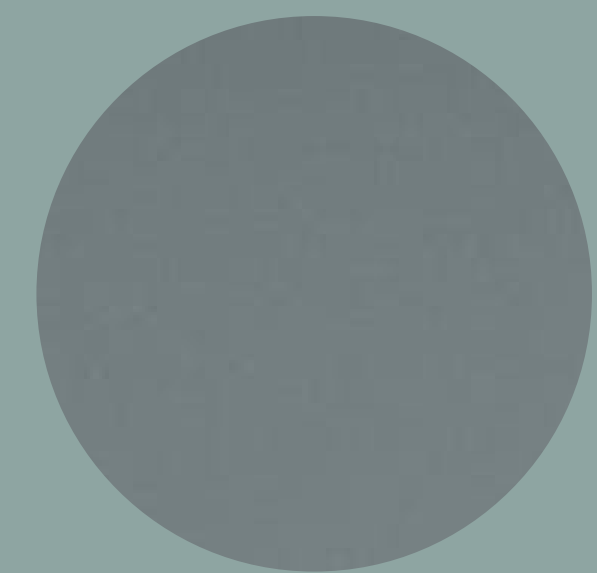

CALA BLUE



ARCILLA RED

DESERT SILVER



SILESTONE ETERNAL



ET NOIR



DESERT SILVER



PEARL JASMINE



CHARCOAL SOAPSTONE



ET MARQUINA

SILESTONE ETERNAL



ET MARQUINA



ET STATUARIO

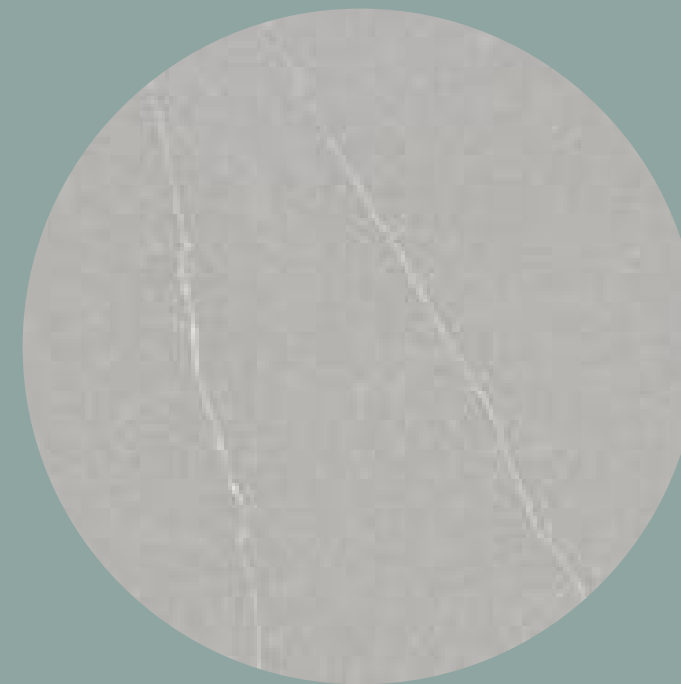

ET SERENA



ET CALACATTA GOLD



MIAMI VENA

SILESTONE NEBULA



MIAMI VENA



LAGOON



SNOWY IBIZA

SILESTONE NEBULA ALPHA



SNOWY IBIZA



ARIEL



CALYPSO

SILESTONE MYTHOLOGY



GRIS EXPO



NEGRO TEBAS 18



MIAMI WHITE 17



BLANCO NORTE 14

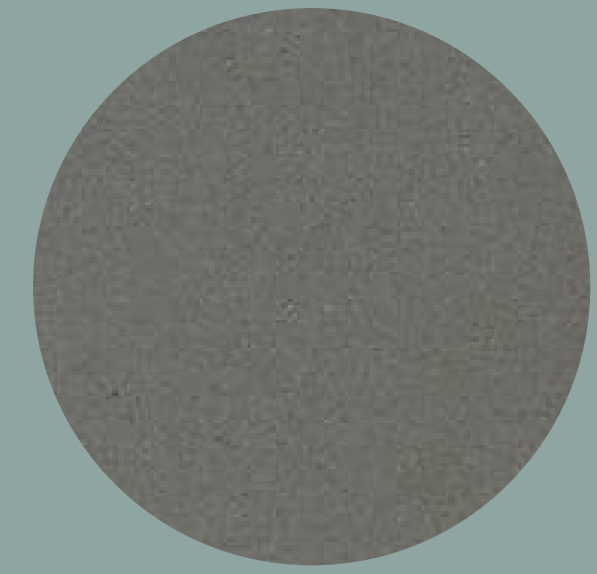

GRIS EXPO



BLANCO ZEUS

CORAL CLAY



SILESTONE BASIQ

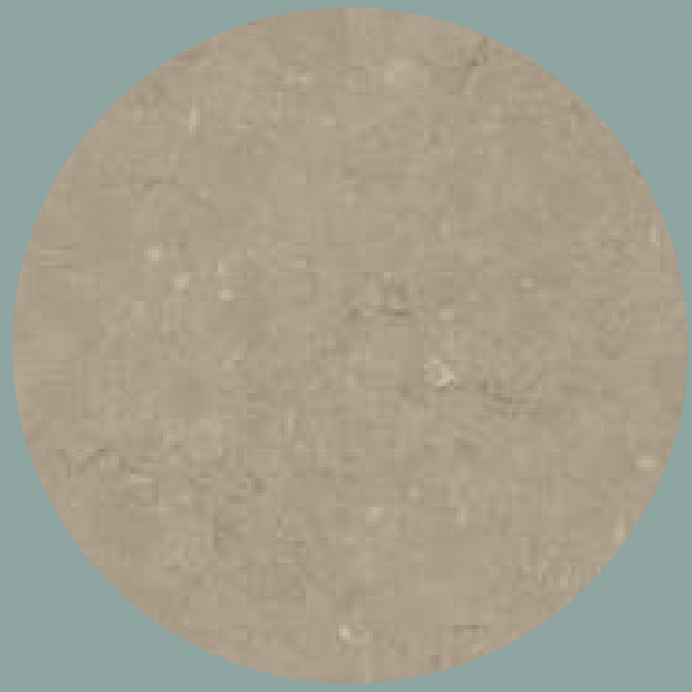

CORAL CLAY COLOUR



WHITE STORM



NIEBLA



ROUGUI



CEMENTO SPA

SILESTONE BASIQ

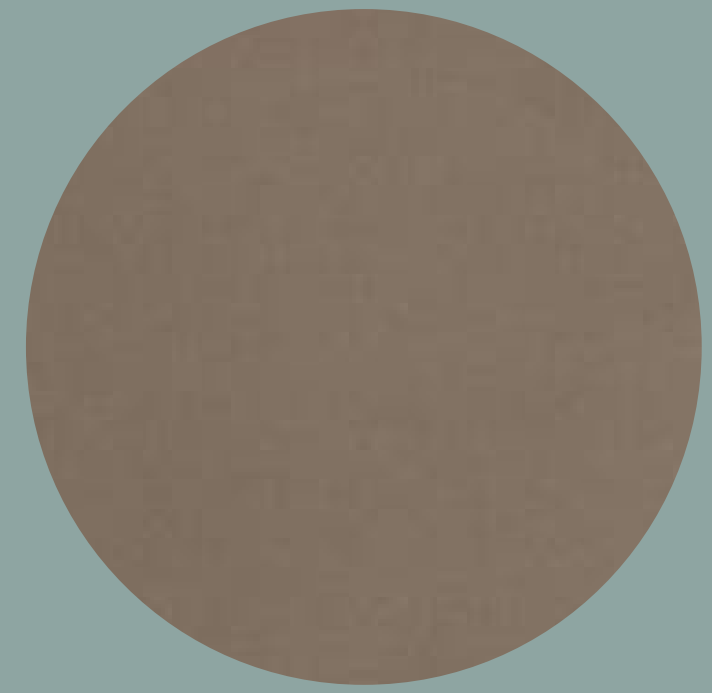

NOKA

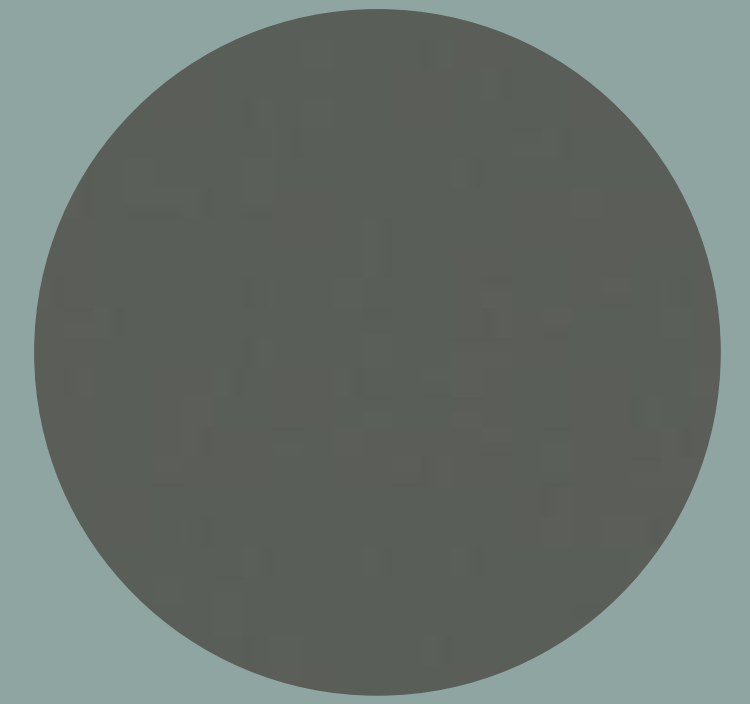

CEMENTO SPA



MARENGO



NEGRO

SILESTONE STELLAR



BLANCO 13



NEGRO



WHITE

SILESTONE ICONIC

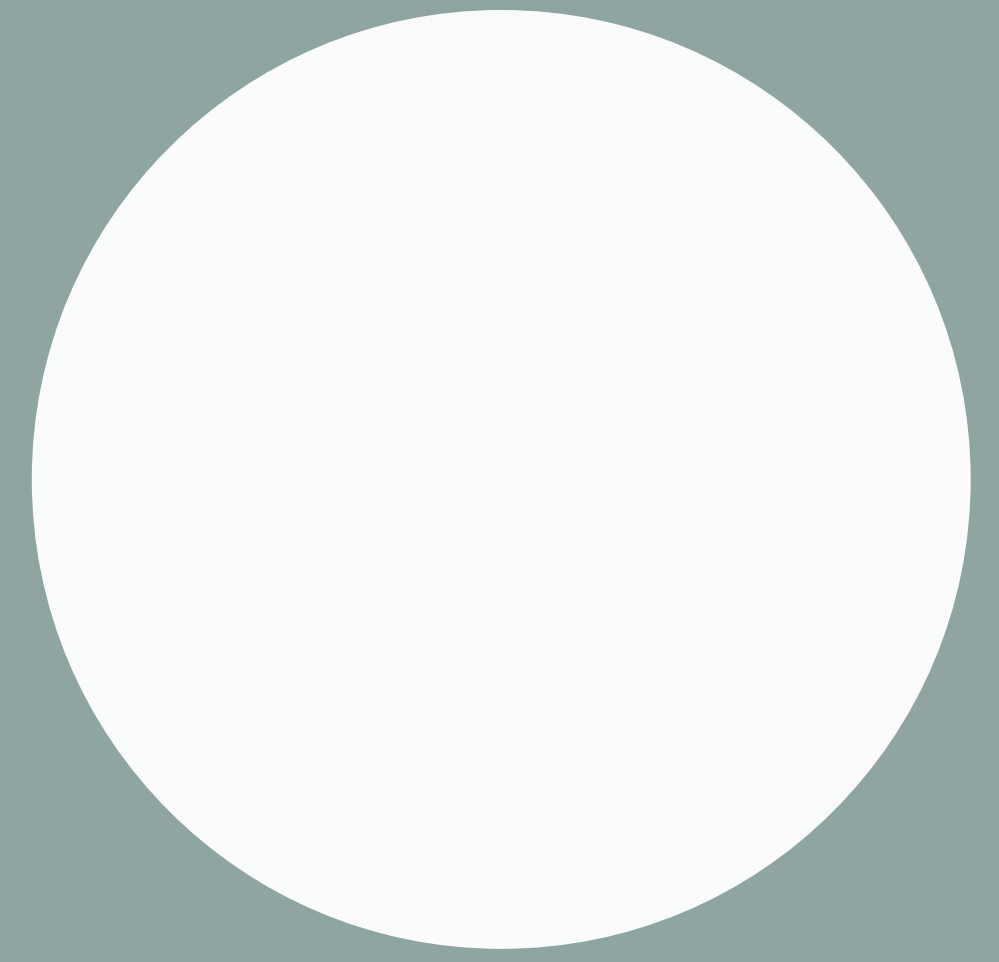

WHITE



BLANCO MAPLE 14



SILESTONE TROPICAL FOREST



BLANCO MAPLE 14

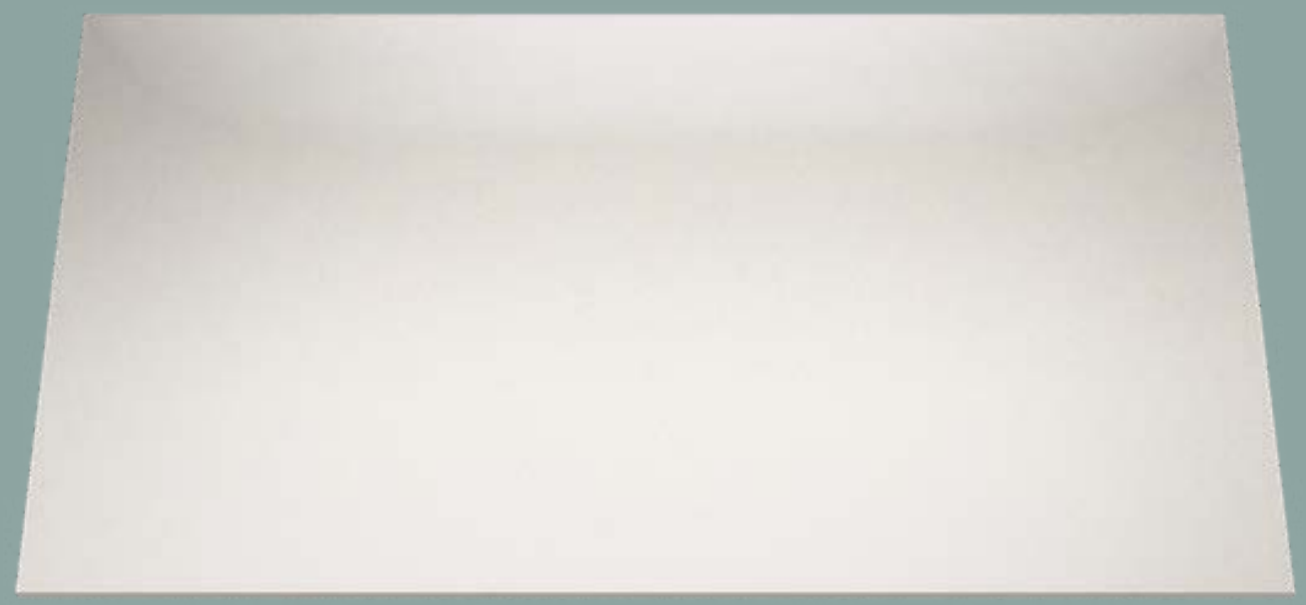



KENSHO

SILESTONE ZEN



KENSHO





ARDEN BLUE

SILESTONE STONE



ARDEN BLUE



YUKON



SILESTONE RIVER



YUKON

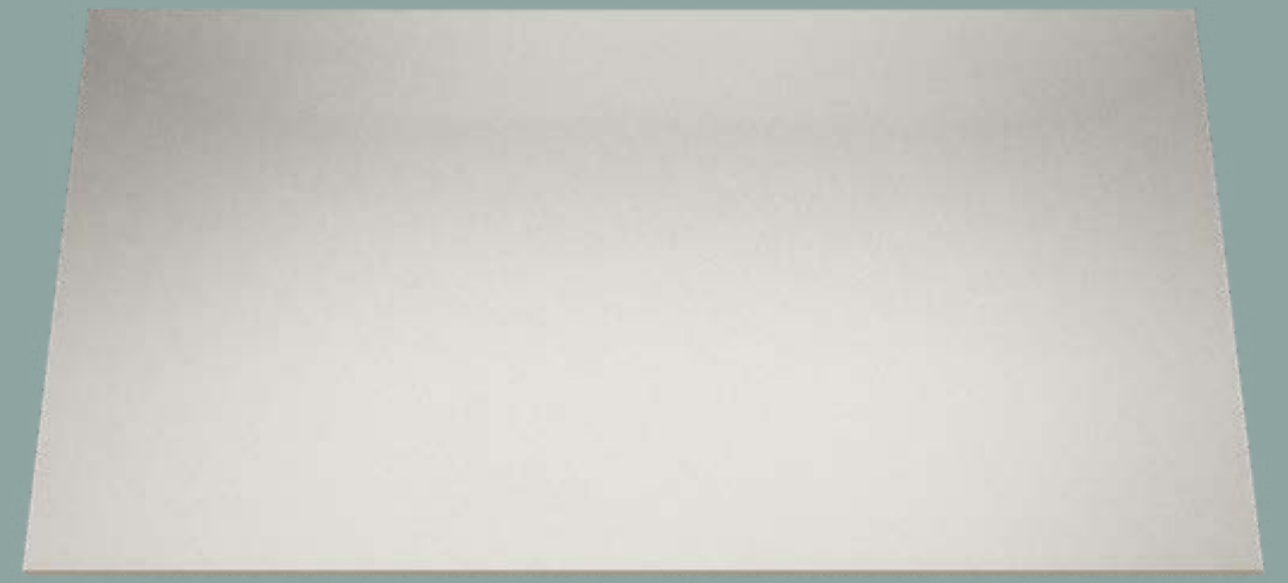

SILESTONE: INSPIRACIÓN MUEBLES



SILESTONE TIPOS DE BORDES

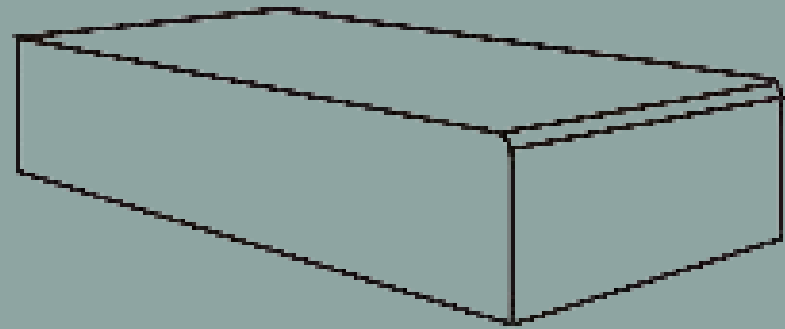

RELIEVE

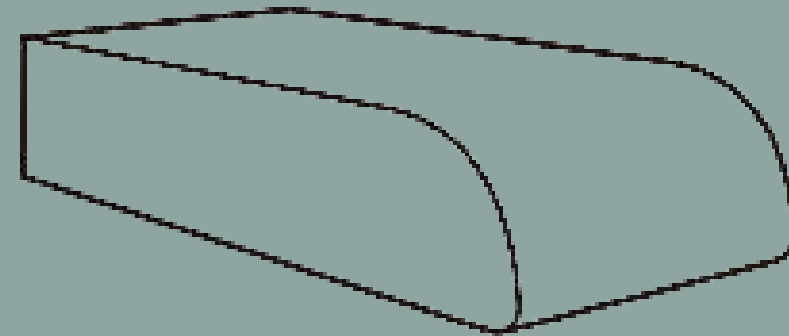

SEMI REDONDO

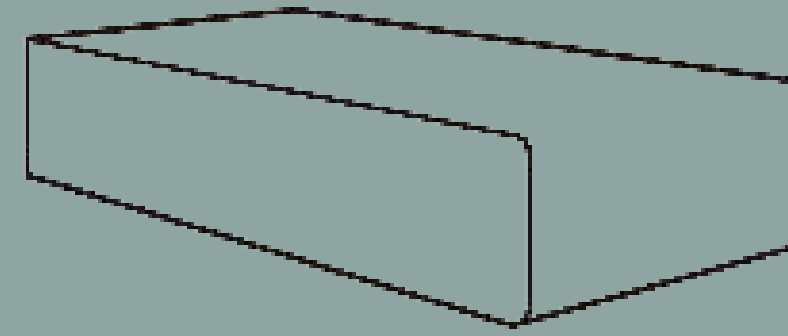

CASCADA

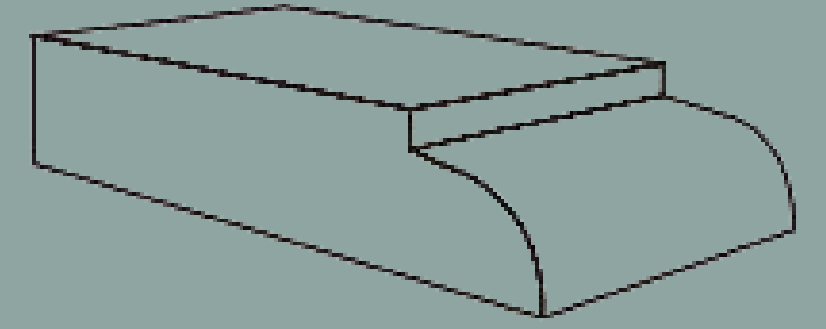

MEDIO ESCALÓN REDONDO

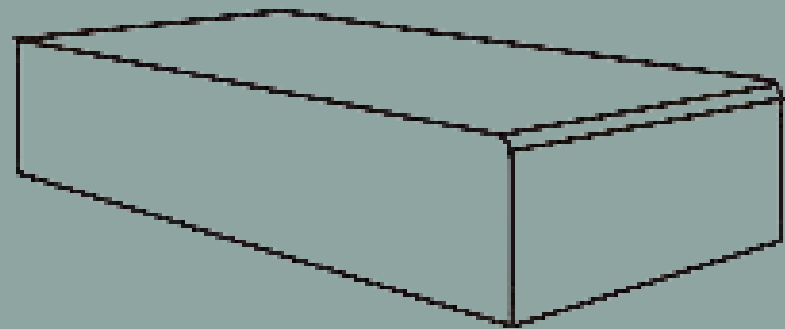

BISEL

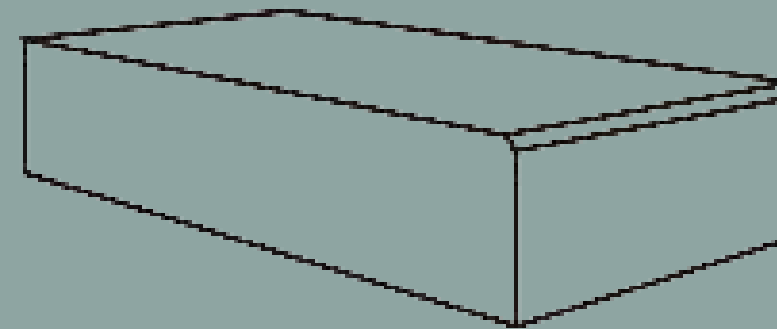

REDONDO

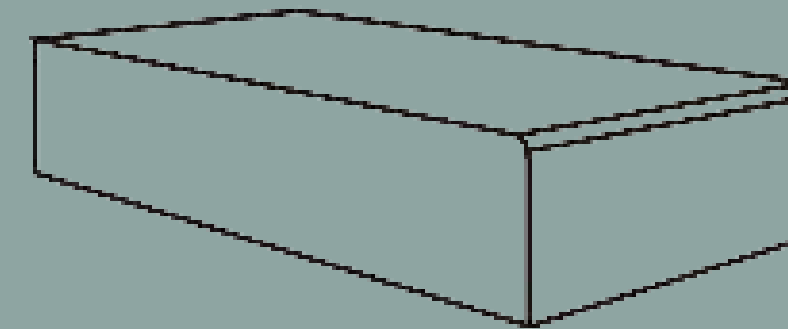

CÓNICO

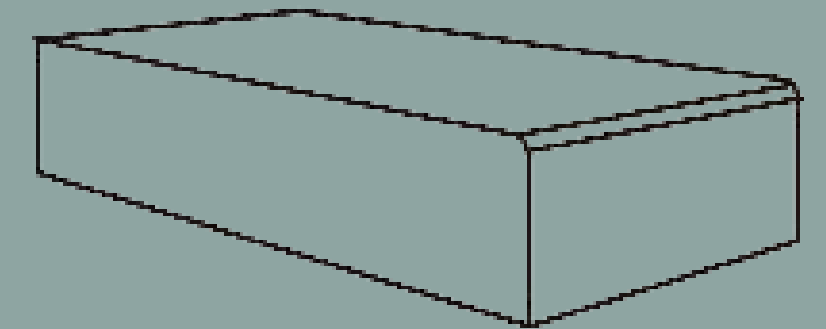

SUPERIOR REDONDEADO

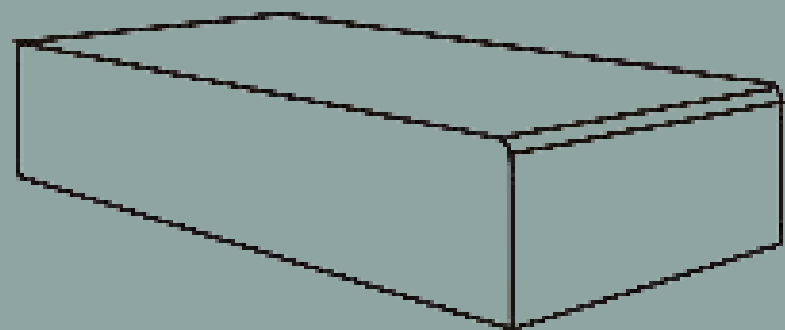

BISEL ACUÑADO

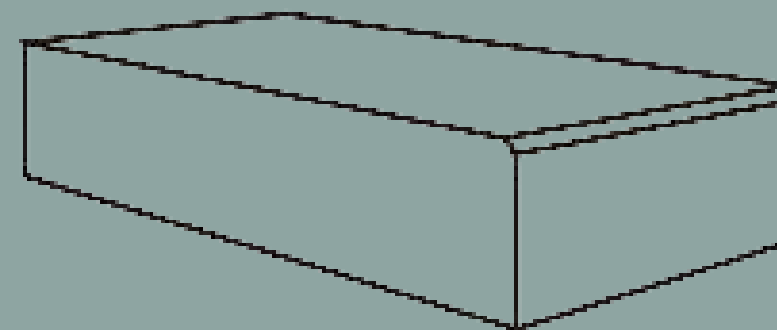

CÓNICO ESPECIAL



DUEL L: 37 X 51 X 15.5 CM



DUEL S: 37 X 34 X 15.5 CM



DUEL XL: 43.5 X 67 X 21 CM



ONE: 41 X 51 X 15.5 CM



Q: 41 X 51 X 17.5 CM



TOP: 37 X 51 X 15.5 CM

SILESTONE INTEGRITY

FREGADEROS







DEKTON

SUPERFICIES ULTRA COMPACTAS

- POR SU VERSATILIDAD Y RESISTENCIA ES IDEAL PARA INTERIORES Y EXTERIORES
- VENTAJAS: RESISTENTE A RAYOS UV, AL RAYADO, A MANCHAS, AL FUEGO Y CALOR, A LA ABRASIÓN Y AL HIELO Y DESHIELO
- MÁS DE 40 COLORES, 5 ESPESORES, GRAN FORMATO QUE PERMITEN LA PERSONALIZACIÓN
- TEXTURAS: PULIDO, MATE LISO, TEXTURIZADO, VELVET



COCINA

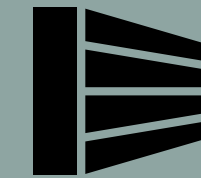

REVESTIMIENTOS



BAÑOS



PISOS

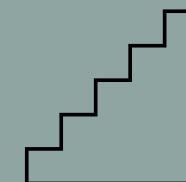

ESCALERAS



TERRAZAS



FACHADAS

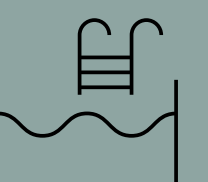

PISCINAS

SUPERFICIES ULTRA COMPACTAS



ESPESOR; 4 MM, 8 MM, 12 MM, 20 MM, 30 MM



MEDIDA NOMINAL MÍNIMA: 320 x 144 cm

DEKTON NATURAL



LAURENT



REM



AERIS



NOCTIS



BROMO



LAURENT

DEKTON NATURAL



KOVIC



SASEA

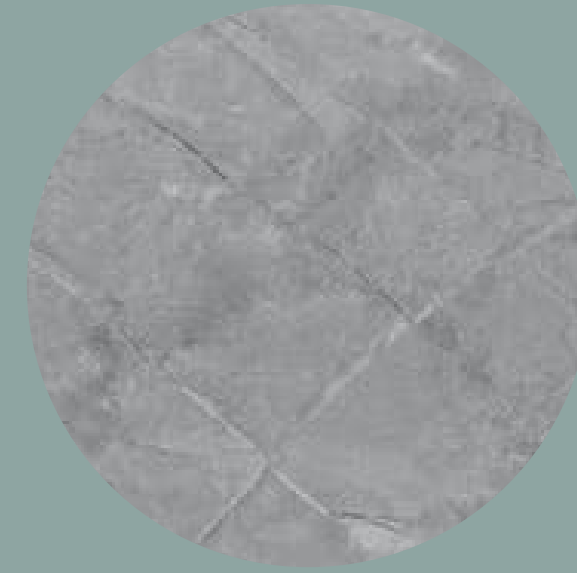

VERA



OPERA



AURA 15

DEKTON NATURAL

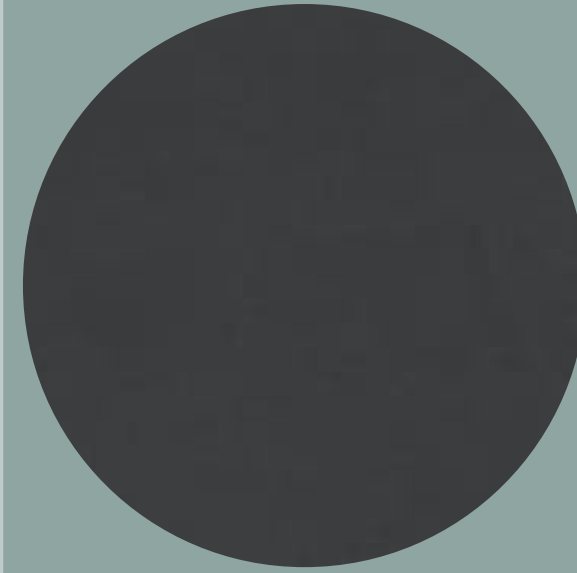

ETER



PORTUM



KIRA



FOSSIL



ENTZO

ENTZO

DEKTON NATURAL



DANAE



KELYA



EDORA



KAIROS



DANAE



SIROCCO

DEKTON INDUSTRIAL



KRETA & ET CALACATTA GOLD

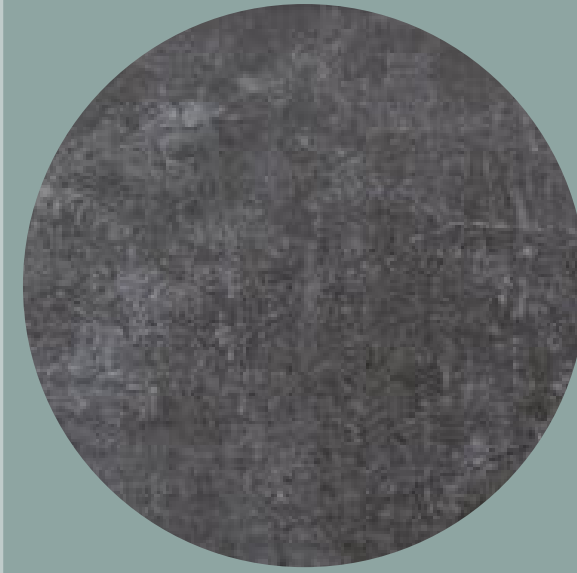

LAOS

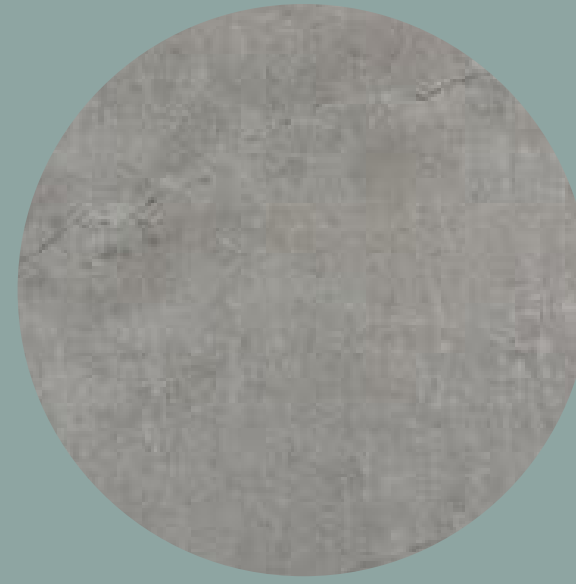

SOKE



KRETA



LUNAR



RADIUM

DEKTON INDUSTRIAL



TRILIUM



NILIUM



TRILIUM

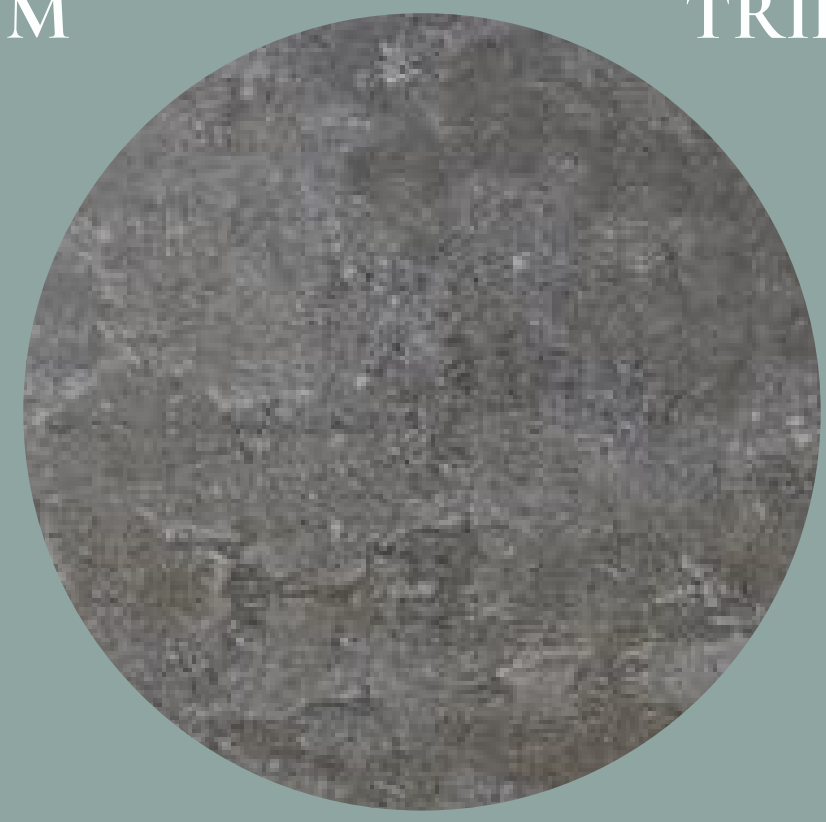

ORIX



DOMOOS, DANAE & KEON



MOONE

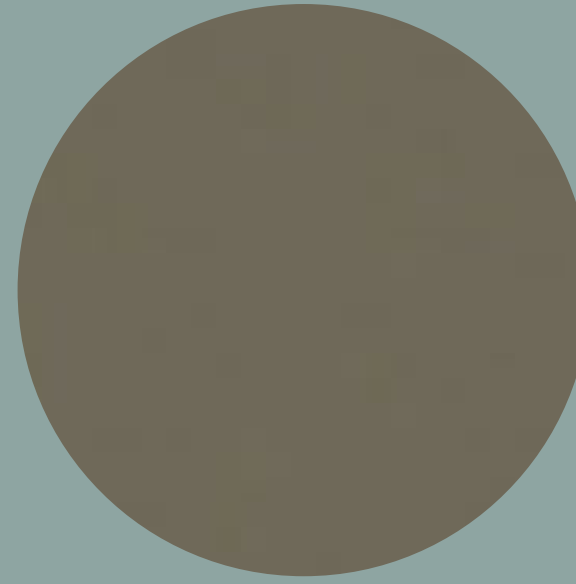

GALEMA



ZENITH



DOMOOS



SIRIUS



HALO

DEKTON SOLID X GLOSS



HALO





UYUNI

DEKTON CHROMICA



UYUNI

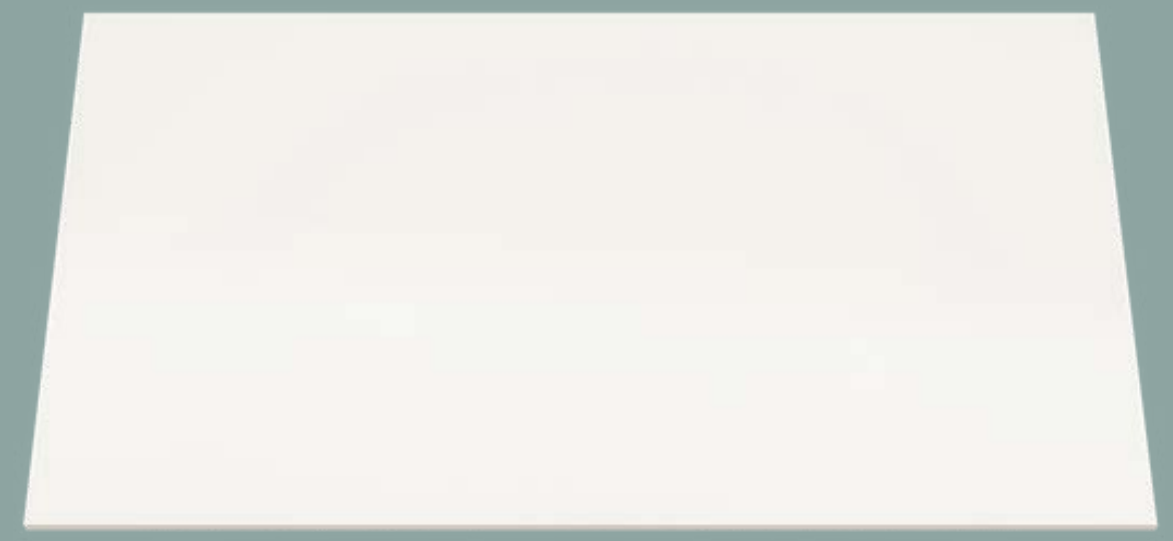

DEKTON STONIKA X GLOSS



OLIMPO



TUNDRA 19



BERGEN



TAGA



ARGA



OLIMPO



NATURA 18

DEKTON STONIKA X GLOSS



NATURA 18





STRATO

DEKTON TECH



KEON



STRATO



DEKTON: INSPIRACIÓN MUEBLES





SENSA

GRANITO NATURAL

- CERTIFICACIÓN PARA EL CONTACTO CON ALIMENTOS
- ALTA RESISTENCIA A LAS MANCHAS
- FÁCIL MANTENIMIENTO
- PIEZAS ÚNICAS POR SUS VETAS, TEXTURAS Y COLORES
- PRODUCTO NATURAL QUE HACE QUE CADA PIEZA SEA ÚNICA E INIGUALABLE



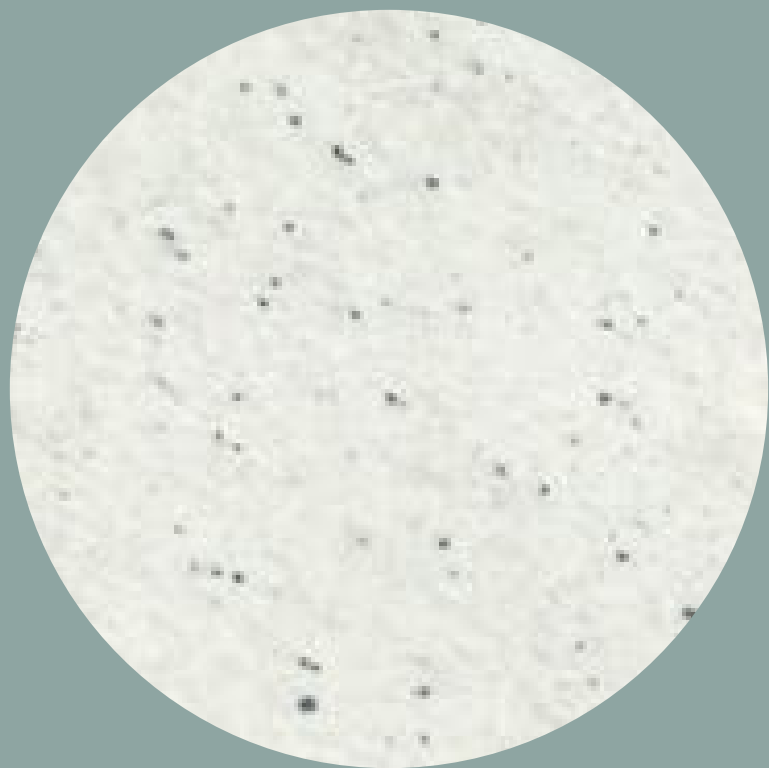

SIBERIA



VANCOUVER



SILVER GRAY

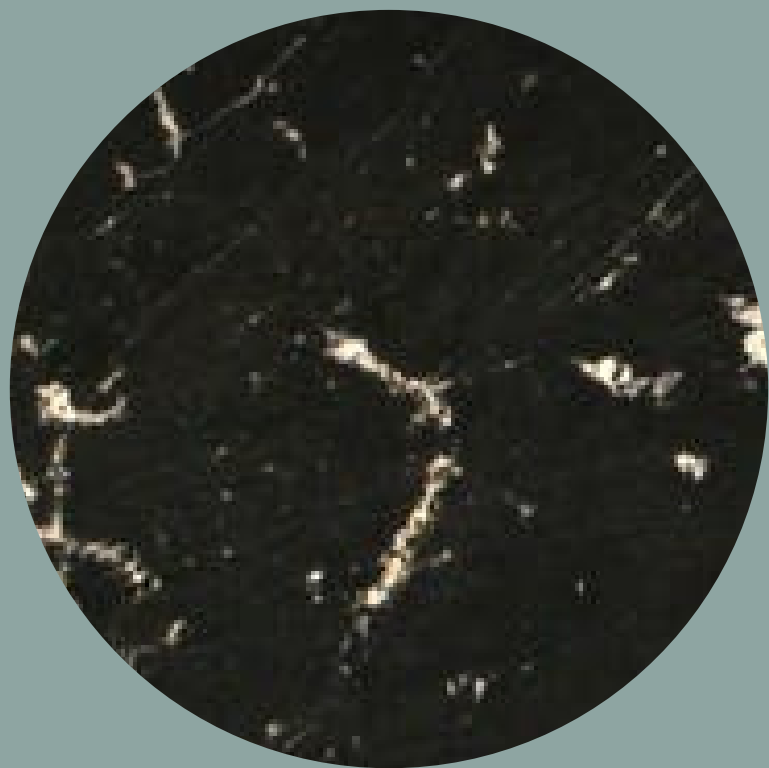

VIA LATTEA



COPACABANA



WHITE EGEO

SENSA PREMIUM



NILO



VENA ORO



TAJ MAHAL



SMOKE



ORINICO

SCALEA

PIEDRA NATURAL



NEGRO SAN GABRIEL



ICE BLUE 19



VANCOUVER

- RESISTENTE AL FUEGO, CALOR, RAYOS UV
- DURABILIDAD SUPERIOR
- FÁCIL MANTENIMIENTO, LIMPIAR SÓLO CON AGUA
- PIEZAS ÚNICAS CREADAS POR LA NATURALEZA LO QUE LA HACE ÚNICA Y ATEMPORAL
- PRODUCTO NATURAL TRADICIONAL: MÁRMOL, GRANITO, CALIZA Y TRAVERTINO

B & L PERSIANAS

COTIZA HOY TUS SUPERFICIES COSENTINO

9932 091211

EMAIL bylpersianas@hotmail.com

VISITA:

www.bylpersianas.com.mx

PLAZA DEPORTIVA PLANTA BAJA LOCAL 14