

GRUBER SYSTEMS RESERVES THE RIGHT TO CHANGE THIS INFORMATION AT ANY TIME WITHOUT PRIOR NOTICE. ISSUED BY GRUBER SYSTEMS INC., 25636 AVENUE STANFORD, VALENCIA, CA 91355, USA. COPYRIGHT 2001

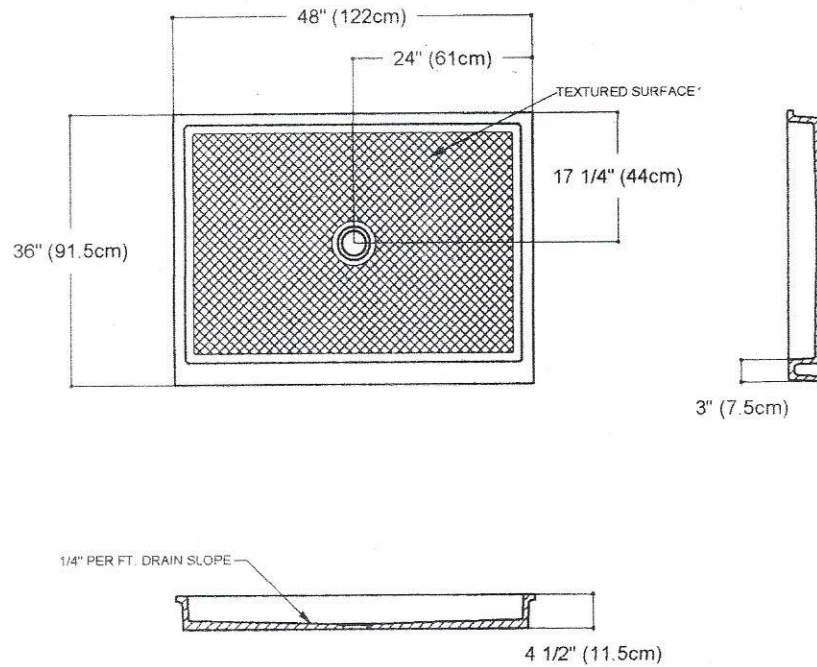

MOLD PART	CATALOG No.	DESCRIPTION
MALE	23009	1050-9 SHOWER T 48 x 36
FEMALE	430098	F 1050-9 INSERT
NAME	1050-9 SHOWER PAN 48 x 36	
CAST WEIGHT	SCALE 1/2" = 1' 0"	DATE 8-1-01
		PAGE No.