

**1** CUBO RUEDA TRASERA

SEBRING 4x2 2007 >  
CALIBER 4x2 2007 - 2010  
AVENGER 4x2 2008 >

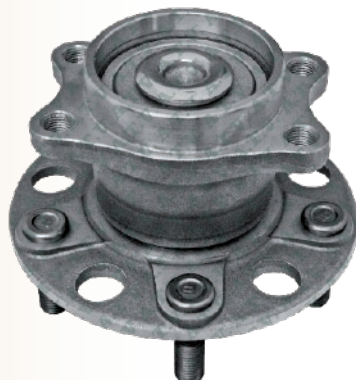

5 BIRLOS

**No. A.T.V. MC4766**

CUBO RUEDA DELANTERA **2**

RAM PICK UP 2500  
LIGTH DUTY  
4x4 1994 - 1999

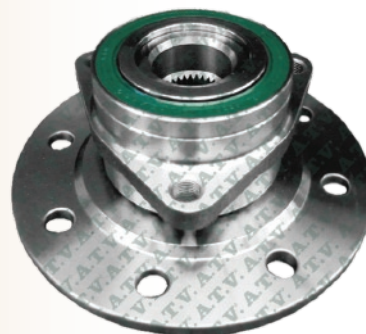

P/8 BIRLOS

**No. A.T.V. MC5011**

**3** CUBO RUEDA DELANTERA

RAM PICK UP 2500  
HEAVY DUTY  
4x4 1994 - 1999



P/8 BIRLOS

**No. A.T.V. MC5012**

CUBO RUEDA DELANTERA **4**

C/CONECTOR ABS

RAM 2500 4x4  
1998 - 1999



8 BIRLOS

**No. A.T.V. MC5035-C**

**5** CUBO RUEDA DELANTERA

RAM I500 4x4  
2000 - 2002

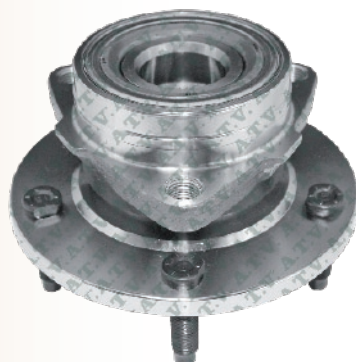

5 BIRLOS

**No. A.T.V. MC5038**

CUBO RUEDA DELANTERA **6**

C/CONECTOR ABS

RAM I500 4x4  
2000 - 2002



5 BIRLOS

**No. A.T.V. MC5039-C**

El uso de las marcas se hace exclusivamente con el propósito de indicar el modelo al que va destinada cada pieza.

Aplicable a:

# CHRYSLER

**1** CUBO RUEDA DELANTERA  
P/FRENOS ABS

RAM I500 4x4  
2000 - 2002

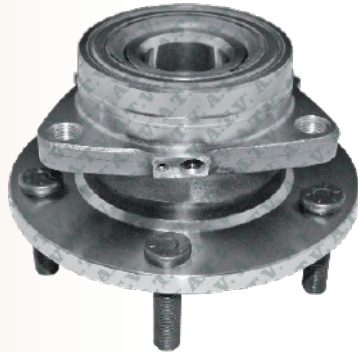

5 BIRLOS

**No. A.T.V. MC5039-S**

**2** CUBO RUEDA DELANTERA  
C/CONECTOR ABS

RAM PICK UP I500  
4x4 1997 - 1999

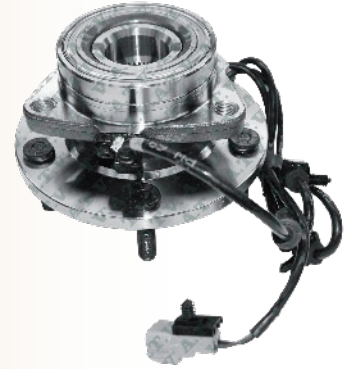

5 BIRLOS

**No. A.T.V. MC5049-C**

**3** CUBO RUEDA DELANTERA  
P/FRENOS ABS

RAM PICK UP I500  
4x4 1997 - 1999

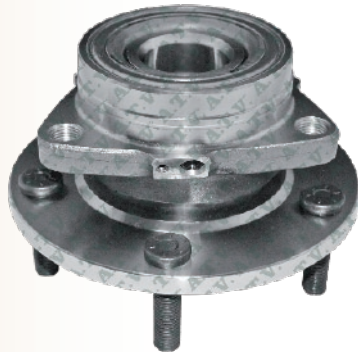

5 BIRLOS

**No. A.T.V. MC5049-S**

**4** CUBO RUEDA TRASERA

AT05 2002 - 2010  
VERNA 2004 - 2006



4 BIRLOS

**No. A.T.V. MC5073**

**5** CUBO RUEDA TRASERA  
C/CONECTOR ABS

JOURNEY 2009 >

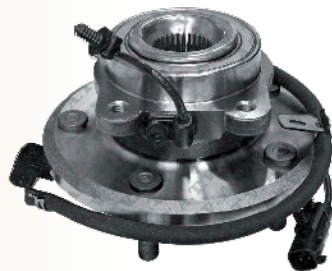

5 BIRLOS

**No. A.T.V. MC5171-C**

**6** CUBO RUEDA TRASERA  
P/FRENOS ABS

JOURNEY 2009 >



5 BIRLOS

**No. A.T.V. MC5171-S**

El uso de las marcas se hace exclusivamente con el propósito de indicar el modelo al que va destinada cada pieza.

**1 MAZA RUEDA DELANTERA**

ATOS 2002 - 2010  
ATTITUDE 2006 - 2009  
VERNA 2004 - 2005



CIRCUNFERENCIA POSICION  
DE BIRLOS 4 EN 100 mm.

**No. A.T.V. MC5175-B**

**KIT MAZA RUEDA DELANTERA 2**

ATOS 2002 - 2010  
ATTITUDE 2006 - 2009  
VERNA 2004 - 2005

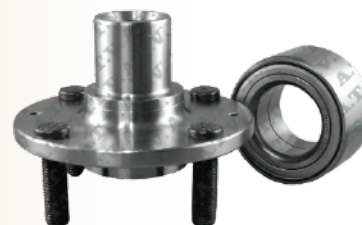

CIRCUNFERENCIA POSICION  
DE BIRLOS 4 EN 100 mm.

**No. A.T.V. MC5175-K**

**3 MAZA RUEDA DELANTERA**

**MITSUBISHI:**  
OUTLANDER LS  
2004 - 2006

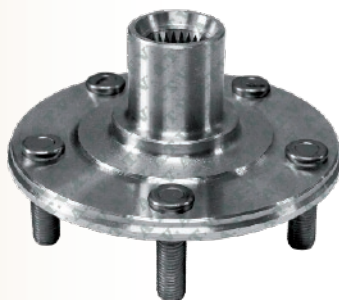

5 BIRLOS

**No. A.T.V. MC5199-B**

**KIT MAZA RUEDA DELANTERA 4**

**MITSUBISHI:**  
OUTLANDER LS  
2004 - 2006

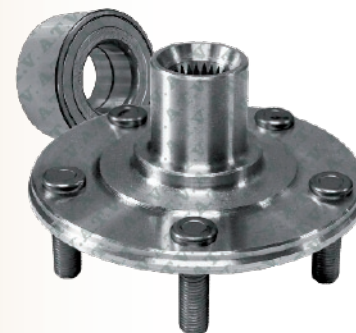

5 BIRLOS

**No. A.T.V. MC5199-K**

**5 CUBO RUEDA DELANTERA**

RAM 1500 4x2  
2000 - 2004

RAM 2500 4x2  
2000 - 2004

RAM CHARGER 4x2  
2000 - 2002

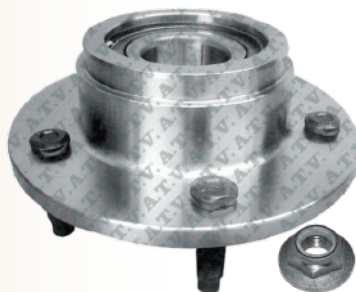

5 BIRLOS

**No. A.T.V. MC5200**

**CUBO RUEDA DELANTERA**

**P/FRENOS ABS**

RAM 1500 4x2  
2000 - 2004

RAM 2500 4x2  
2000 - 2004

RAM CHARGER 4x2  
2000 - 2002

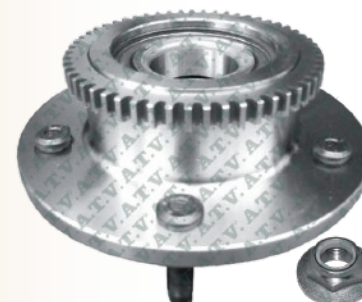

5 BIRLOS

**No. A.T.V. MC5200-S**

El uso de las marcas se hace exclusivamente con el propósito de indicar el modelo al que va destinada cada pieza.

Aplicable a:

# CHRYSLER

## 1 CUBO RUEDA DELANTERA C/CONECTOR ABS

RAM 3500 4x2 2005 >  
RAM 4000 4x2 2005 >

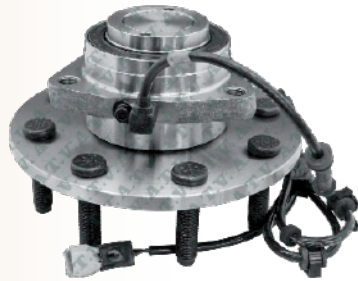

8 BIRLOS

**No. A.T.V. MC5201-C**

## 2 CUBO RUEDA DELANTERA P/FRENOS ABS

RAM 3500 4x2 2005 >  
RAM 4000 4x2 2005 >



8 BIRLOS

**No. A.T.V. MC5201-S**

## 3 CUBO RUEDA DELANTERA P/FRENOS ABS

RAM 4000 4x2  
2000 - 2004



8 BIRLOS

**No. A.T.V. MC5228-S**

## 4 CUBO RUEDA TRASERA

ATTITUDE 2006 - 2008

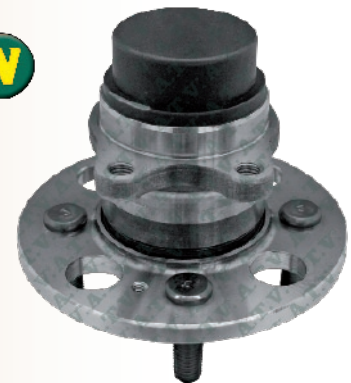

4 BIRLOS

**No. A.T.V. MC5275**

## 5 CUBO RUEDA TRASERA C/CONECTOR ABS

ATTITUDE 2006 - 2008

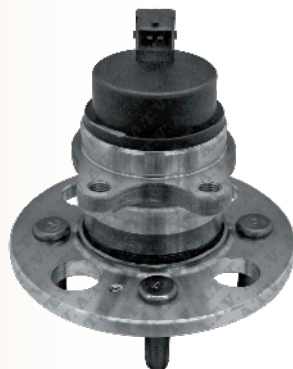

4 BIRLOS

**No. A.T.V. MC5275-C**

## 6 CUBO RUEDA DELANTERA C/ENCODER INTEGRADO

CALIBER  
AVENGER  
SEBRING

TURBOS 2007 - 2009



5 BIRLOS

**No. A.T.V. MC5406-E**

El uso de las marcas se hace exclusivamente con el propósito de indicar el modelo al que va destinada cada pieza.

1 MAZA RUEDA DELANTERA

CALIBER 2007 - 2009

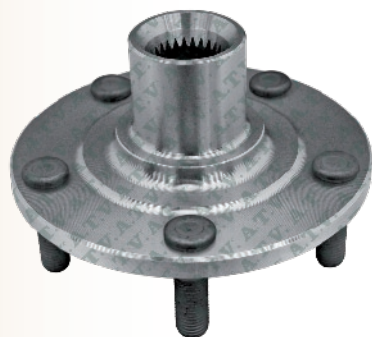

5 BIRLOS

**No. A.T.V. MC5702-B**

KIT MAZA RUEDA DELANTERA 2

CALIBER 2007 - 2009

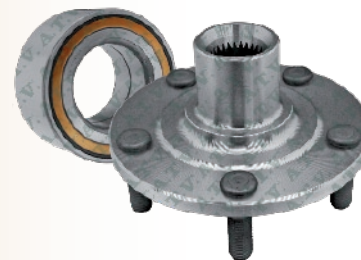

5 BIRLOS

**No. A.T.V. MC5702-K**

3 KIT MAZA RUEDA DELANTERA

RODAMIENTO CON  
CODIFICADOR ABS

CALIBER 2007 - 2009

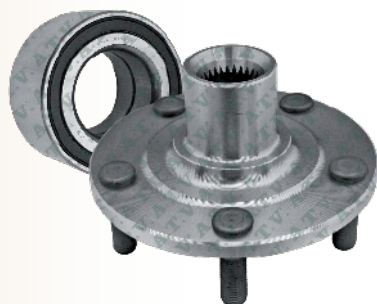

5 BIRLOS

**No. A.T.V. MC5702-KE**

CUBO RUEDA TRASERA 4

C/ENCODER INTEGRADO

COMPASS  
PATRIOT  
4x4 2007 - 2010

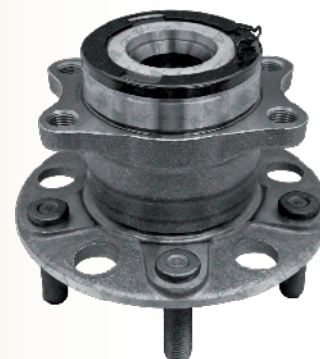

5 BIRLOS

**No. A.T.V. MC5770-E**

5 CUBO RUEDA TRASERA

STRATUS 1995 - 2006

CIRRUS 1995 - 2000  
SEBRING 1995 - 2000

BREZZE 1996 - 2000

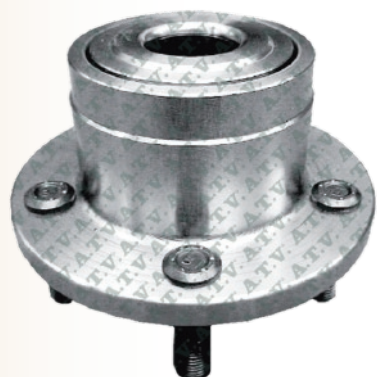

5 BIRLOS

**No. A.T.V. MC6477**

CUBO RUEDA TRASERA 6

P/FRENOS ABS

SEBRING  
CALIBER  
COMPASS  
PATRIOT

4x2 2007 - 2010

AVENGER 4x2 2008 - 2010

MITSUBISHI:  
OUTLANDER 4x2 2007 >

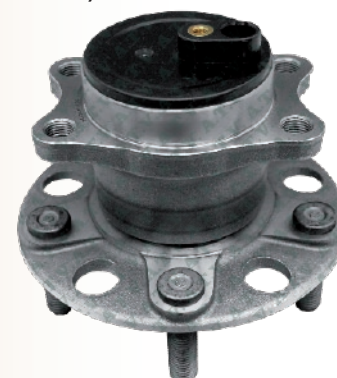

5 BIRLOS

**No. A.T.V. MC6719-S**

El uso de las marcas se hace exclusivamente con el propósito de indicar el modelo al que va destinada cada pieza.

Aplicable a:

# CHRYSLER

## 1 CUBO RUEDA DELANTERA

CHEROKEE  
GRAND CHEROKEE  
COMANCHE  
GRAND WAGONEER  
WAGONEER  
WRANGLER  
CJ5, CJ7, CJ8, CJ10

4x4  
1990 - 1999



5 BIRLOS

**No. A.T.V. MC7449**

## 2 CUBO RUEDA DELANTERA

C/CONECTOR ABS

TOWN & COUNTRY  
2008 - 2010

GRAND CARAVAN  
2008 - 2010

VOYAGER 2008

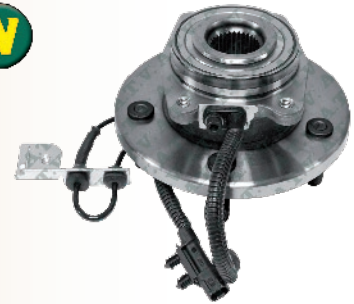

5 BIRLOS

**No. A.T.V. MC7621-C**

## 3 CUBO RUEDA DELANTERA

SIN ASTRIADO

RAM 3500 4x2  
1992 - 1996

RAM 4000 4x2  
1997 - 1999

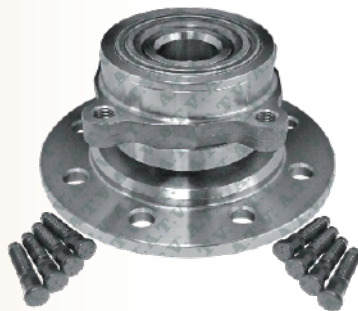

8 BIRLOS

**No. A.T.V. MC8208**

## 4 CUBO RUEDA DELANTERA

RAM 1500  
RAM 2500  
BI500

4x4 1994 - 2002

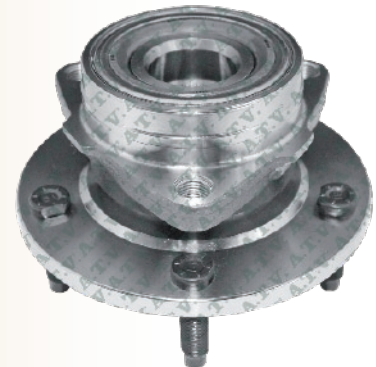

5 BIRLOS

**No. A.T.V. MC8220**

## 5 CUBO RUEDA DELANTERA

JEEP LIBERTY 4x4  
2002 - 2006

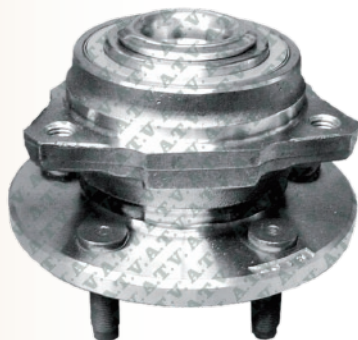

5 BIRLOS

**No. A.T.V. MC8352**

## 6 CUBO RUEDA DELANTERA

C/CONECTOR ABS

JEEP LIBERTY 4x2 / 4x4  
2000 - 2006



5 BIRLOS

**No. A.T.V. MC8692-C**

El uso de las marcas se hace exclusivamente con el propósito de indicar el modelo al que va destinada cada pieza.

**1 CUBO RUEDA TRASERA**

**P/FRENOS ABS**

JEEP COMMANDER  
4x2 / 4x4 2005 - 2009

JEEP GRAND CHEROKEE  
4x2 / 4x4 2005 - 2010



5 BIRLOS

**No. A.T.V. MC8840-S**

**2 CUBO RUEDA DELANTERA**

300M  
CONCORDE  
DAYTONA  
DYNASTY  
INTREPID  
1993 - 2000

LHS  
NEW YORKER  
1994 - 2000

PROWLER 1997 - 2001  
VISION 1993 - 1997

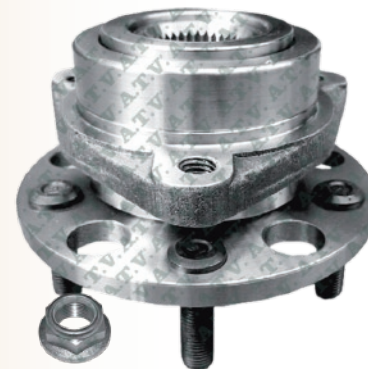

5 BIRLOS

**No. A.T.V. MC8867**

**3 CUBO RUEDA DELANTERA**

**C/CONECTOR ABS**

DAKOTA 4x4  
1997 - 2002

DURANGO 4x4  
1998 - 2003



6 BIRLOS

**No. A.T.V. MC8964-C**

**4 CUBO RUEDA DELANTERA**

**PARA FRENOS ABS**

DAKOTA 4x4  
1997 - 2002

DURANGO 4x4  
1998 - 2003

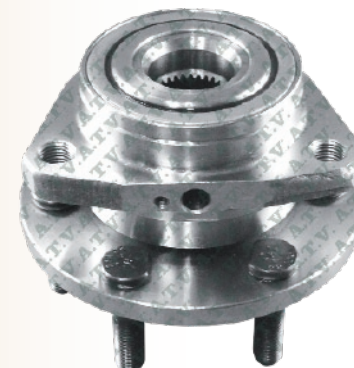

6 BIRLOS

**No. A.T.V. MC8964-S**

**5 CUBO RUEDA DELANTERA**

**C/ENCODER INTEGRADO**

300C 4x2 2005>

CHARGER 4x2 2006>



5 BIRLOS

**No. A.T.V. MC9199-E**

**6 CUBO RUEDA TRASERA**

300C 4x2 2005>

CHARGER 4x2 2006>

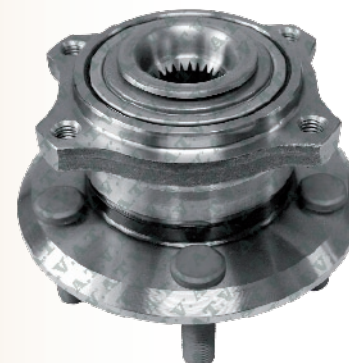

5 BIRLOS

**No. A.T.V. MC9328**

El uso de las marcas se hace exclusivamente con el propósito de indicar el modelo al que va destinada cada pieza.

# CHRYSLER

## 1 CUBO RUEDA DELANTERA CON ASTRIADO

RAM 3500 4x2  
1992 - 1996

RAM 4000 4x2  
1997 - 1999



8 BIRLOS

**No. A.T.V. MC9338**

## 2 CUBO RUEDA DELANTERA

DAKOTA 4x4  
1997 - 2002

DURANGO 4x4  
1997 - 2002



6 BIRLOS

**No. A.T.V. MC9361**

## 3 CUBO RUEDA DELANTERA

DAKOTA 4x2  
2002 - 2004

DURANGO 4x2  
2002 - 2004



6 BIRLOS

**No. A.T.V. MC9406**

## 4 CUBO RUEDA DELANTERA P/FRENOS ABS

DAKOTA 4x2  
2002 - 2004

DURANGO 4x2  
2002 - 2004

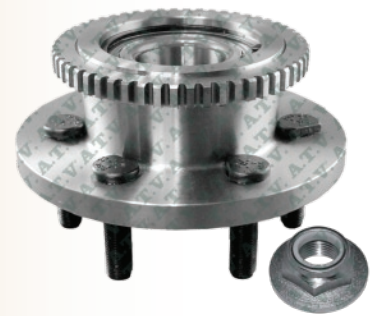

6 BIRLOS

**No. A.T.V. MC9406-S**

## 5 CUBO RUEDA DELANTERA C/CONECTOR ABS

JEEP COMMANDER  
4x2 / 4x4 2005 - 2009

JEEP GRAND CHEROKEE  
4x2 / 4x4 2005 - 2010

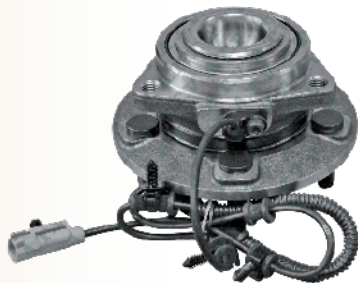

5 BIRLOS

**No. A.T.V. MC9434-C**

## 6 MAZA RUEDA DELANTERA

MITSUBISHI:  
LANCER LS DIAMOND  
2003 - 2007



4 BIRLOS

**No. A.T.V. MC9489-B**

El uso de las marcas se hace exclusivamente con el propósito de indicar el modelo al que va destinada cada pieza.



**1** KIT MAZA RUEDA DELANTERA

**MITSUBISHI:**  
LANCER LS DIAMOND  
2003 - 2007



4 BIRLOS

**No. A.T.V. MC9489-K**

MAZA RUEDA DELANTERA **2**

ATOS 2001

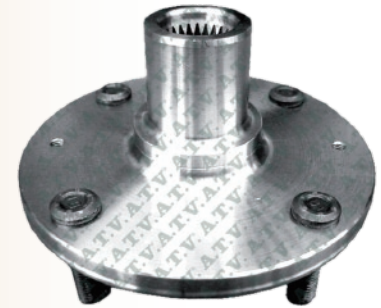

CIRCUNFERENCIA POSICION  
DE BIRLOS 4 EN 114.3 mm.

**No. A.T.V. MC9551-B**

**3** CUBO RUEDA DELANTERA

**C/CONECTOR ABS**

NITRO 4x2 2007 - 2010

JEEP LIBERTY  
4x2 / 4x4 2007 - 2010



5 BIRLOS

**No. A.T.V. MC9947-C**

El uso de las marcas se hace exclusivamente con el propósito de indicar el modelo al que va destinada cada pieza.

Aplicable a:

**FORD**

**1 MAZA RUEDA DELANTERA**

ESCAPE 2001 - 2009

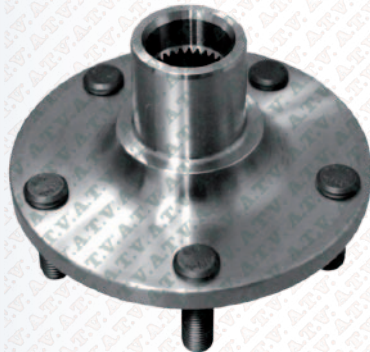

5 BIRLOS

**No. A.T.V. MF0069-B**

**2 KIT MAZA RUEDA DELANTERA**

ESCAPE 2001 - 2009

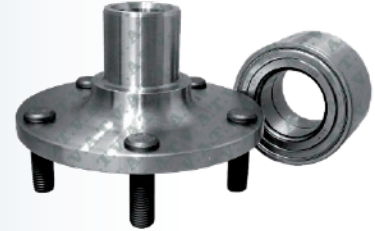

5 BIRLOS

**No. A.T.V. MF0069-K**

**3 CUBO RUEDA TRASERA**

**C/CONECTOR ABS**

MONDEO 2000 - 2007

JAGUAR: X-TYPE 2WD  
2002 - 2004

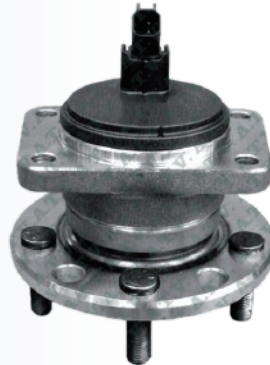

5 BIRLOS

**No. A.T.V. MF0078-C**

**4 KIT MAZA RUEDA DELANTERA**

**RODAMIENTO CON  
CODIFICADOR ABS**

FOCUS 2000 - 2006



4 BIRLOS

**No. A.T.V. MF0263-KE**

**5 CUBO RUEDA TRASERA**



MAZDA:  
3 2004 - 2009

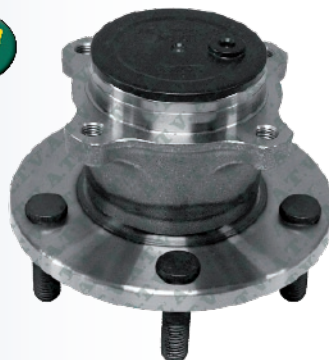

5 BIRLOS

**No. A.T.V. MF0680**

**6 MAZA RUEDA DELANTERA**

MONDEO 2000 - 2007

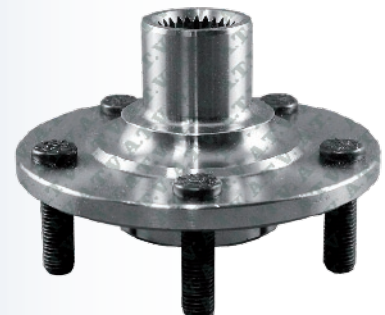

5 BIRLOS

**No. A.T.V. MF068C-B**

El uso de las marcas se hace exclusivamente con el propósito de indicar el modelo al que va destinada cada pieza.

**1 KIT MAZA RUEDA DELANTERA**

**RODAMIENTO CON  
CODIFICADOR ABS**

MONDEO 2000 - 2007

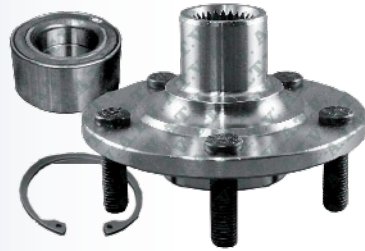

5 BIRLOS

**No. A.T.V. MF068C-KE**

**2 CUBO RUEDA DELANTERA**

**C/CONECTOR ABS**

F-450 4x4 2005 >  
F-550 4x4 2005 >



10 BIRLOS

**No. A.T.V. MF0937-C**

**3 CUBO RUEDA DELANTERA**

**C/CONECTOR ABS**

F-450 4x2 2005 >  
F-550 4x2 2005 >



10 BIRLOS

**No. A.T.V. MF1022-C**

**4 CUBO RUEDA DELANTERA**

**P/FRENOS ABS**

F-450 4x2 2005 >  
F-550 4x2 2005 >



10 BIRLOS

**No. A.T.V. MF1022-S**

**5 CUBO RUEDA TRASERA**

WINDSTAR 1995 - 2000

SABLE  
TAURUS  
1990 - 1995 MEX.  
1990 - 1993 USA.

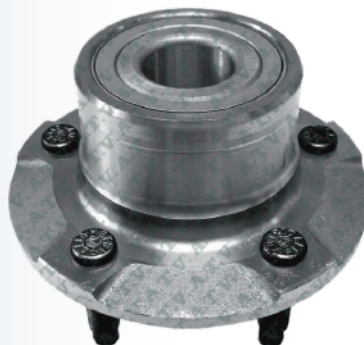

5 BIRLOS

**No. A.T.V. MF1104**

**6 CUBO RUEDA TRASERA**

**P/FRENOS ABS**

WINDSTAR 1995 - 2000

LINCOLN CONTINENTAL  
1990 - 1992

SABLE  
TAURUS  
1990 - 1995 MEX.  
1990 - 1993 USA.

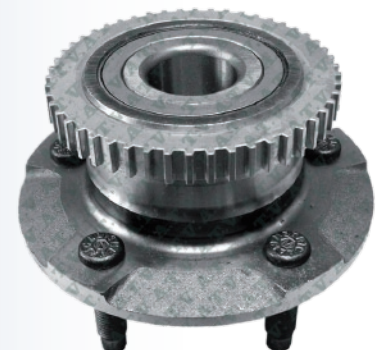

5 BIRLOS

**No. A.T.V. MF1104-S**

El uso de las marcas se hace exclusivamente con el propósito de indicar el modelo al que va destinada cada pieza.

Aplicable a:

# FORD

## 1 MAZA RUEDA DELANTERA

ECOSPORT 2004 - 2007  
FIESTA 1998 - 2006  
FOCUS 1998 - 2004  
KA 2001 - 2008



4 BIRLOS

**No. A.T.V. MF1106-B**

## 2 KIT REPUESTO MAZA RUEDA DELANTERA

ECOSPORT 2004 - 2007  
FIESTA 1998 - 2006  
FOCUS 1998 - 2004  
KA 2001 - 2008



4 BIRLOS

**No. A.T.V. MF1106-RP**

## 3 CUBO RUEDA TRASERA

P/FRENOS ABS

MERCURY:  
VILLAGER 1997 - 2002



5 BIRLOS

**No. A.T.V. MF1131-S**

## 4 HORQUILLA RUEDA DELANTERA

TRANSIT 2007 - 2010



**No. A.T.V. MF1210**

## 5 CUBO RUEDA TRASERA

TRANSIT 2007 - 2010

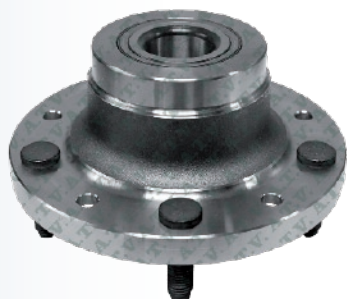

5 BIRLOS

**No. A.T.V. MF1219**

## 6 CUBO RUEDA DELANTERA

C/CONECTOR ABS

F-250  
F-350  
F-450  
TRITON  
4x2 2001 - 2004  
DIESEL / GASOLINA



8 BIRLOS

**No. A.T.V. MF1359-C**

El uso de las marcas se hace exclusivamente con el propósito de indicar el modelo al que va destinada cada pieza.

**1 CUBO RUEDA DELANTERA**

**C/ENCODER INTEGRADO**

FOCUS EUROPA  
2007 - 2010



5 BIRLOS

**No. A.T.V. MF1471-E**

**2 CUBO RUEDA TRASERA**

**P/FRENOS ABS**

CONTOUR  
COUGAR  
MYSTIQUE

1995 - 2000

COURIER 2006 >

TRACCIÓN DELANTERA

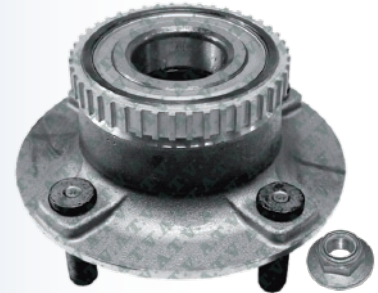

**No. A.T.V. MF2024-S**

**3 CUBO RUEDA TRASERA**

**P/FRENOS ABS**

WINDSTAR 1997 - 2003

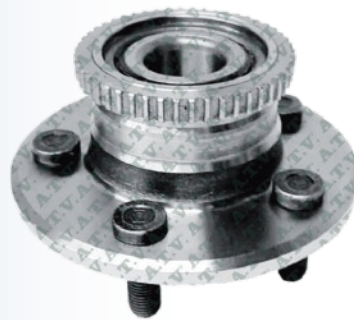

5 BIRLOS

**No. A.T.V. MF2149-S**

**4 CUBO RUEDA TRASERA**

**P/FRENOS ABS**

**MAZDA:**  
3 2004 - 2012  
5 2006 - 2010

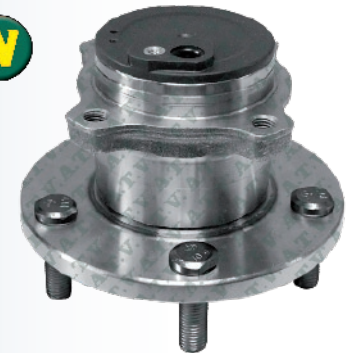

5 BIRLOS

**No. A.T.V. MF2347-S**

**5 CUBO RUEDA TRASERA**

**P/FRENOS ABS**

LINCOLN MKZ 2006 - 2009  
FUSION 2006 - 2007

**MAZDA:** 6 2006 - 2009



5 BIRLOS

**No. A.T.V. MF2634-S**

**6 CUBO RUEDA DELANTERA IZQUIERDA**

**C/CONECTOR ABS**

FREESTAR 2004 - 2007



5 BIRLOS

**No. A.T.V. MF2ZAA-C**

El uso de las marcas se hace exclusivamente con el propósito de indicar el modelo al que va destinada cada pieza.

# FORD

## 1 CUBO RUEDA DELANTERA P/FRENOS ABS

THUNDERBIRD 1989 - 1990  
COUGAR 1989 - 1990  
TRACCIÓN TRASERA

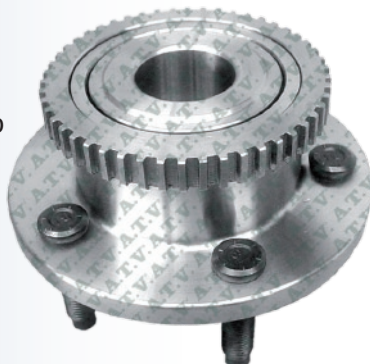

5 BIRLOS

**No. A.T.V. MF3076-S**

## 2 CUBO RUEDA DELANTERA 2

THUNDERBIRD 1989 - 1993  
COUGAR 1989 - 1993  
TRACCIÓN TRASERA

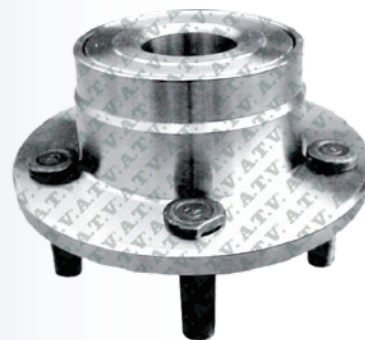

5 BIRLOS

**No. A.T.V. MF3077**

## 3 CUBO RUEDA DELANTERA P/FRENOS ABS

THUNDERBIRD 1991 - 1997  
COUGAR 1991 - 1997  
LINCOLN MARK VIII  
1993 - 1998  
TRACCIÓN TRASERA

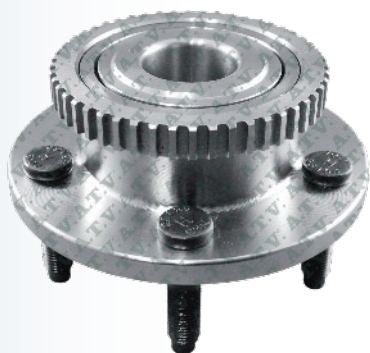

5 BIRLOS

**No. A.T.V. MF3092-S**

## 4 CUBO RUEDA DELANTERA 4

LINCOLN CONTINENTAL  
TAURUS  
1996 - 2002  
SABLE 1995 - 2002

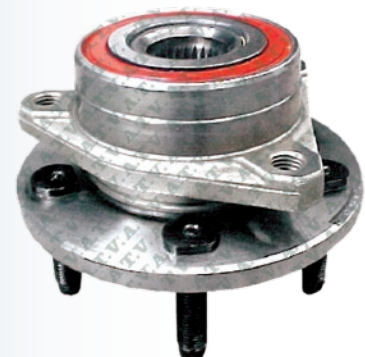

5 BIRLOS

**No. A.T.V. MF3100**

## 5 CUBO RUEDA DELANTERA P/FRENOS ABS

MUSTANG 1993 - 2002



5 BIRLOS

**No. A.T.V. MF3115-S**

## 6 CUBO RUEDA DELANTERA 6

WINDSTAR LIMITED 2000  
2000 - 2003

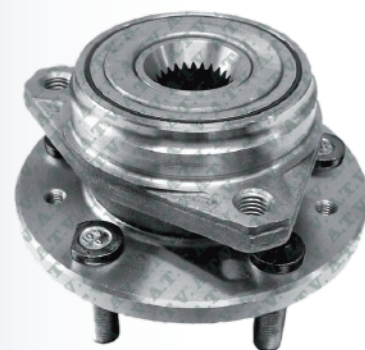

5 BIRLOS

**No. A.T.V. MF3156**

El uso de las marcas se hace exclusivamente con el propósito de indicar el modelo al que va destinada cada pieza.

**1 CUBO RUEDA DELANTERA**

CROWN VICTORIA  
GRAND MARQUIS  
LINCOLN CONTINENTAL  
LINCOLN TOWN CAR

DESDE ABRIL DEL  
1997-2002  
TRACCIÓN TRASERA

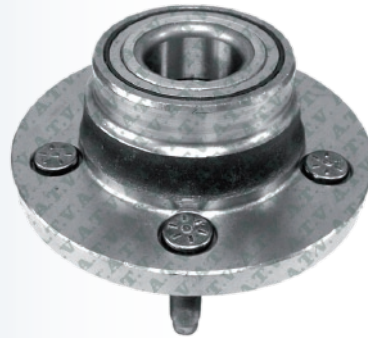

5 BIRLOS

**No. A.T.V. MF3202**

**2 CUBO RUEDA DELANTERA**

**P/FRENOS ABS**

CROWN VICTORIA  
GRAND MARQUIS  
LINCOLN CONTINENTAL  
LINCOLN TOWN CAR

DESDE ABRIL DE  
1997 - 2002  
TRACCIÓN TRASERA

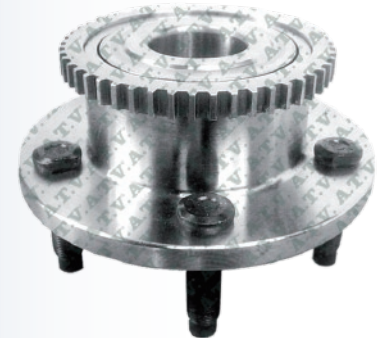

5 BIRLOS

**No. A.T.V. MF3202-S**

**3 CUBO RUEDA DELANTERA**

**C/ENCODER INTEGRADO**



MAZDA:  
3 2004 - 2009



5 BIRLOS

**No. A.T.V. MF3211-E**

**4 KIT MAZA RUEDA TRASERA**

ESCAPE 2001 - 2005



5 BIRLOS

**No. A.T.V. MF3966-K**

**5 CUBO RUEDA DELANTERA DERECHA**

**C/CONECTOR ABS**

FREESTAR 2004 - 2007

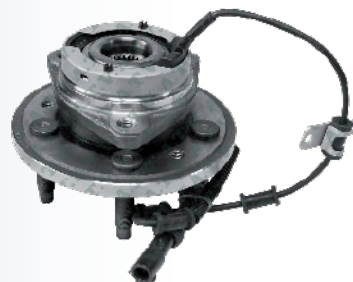

5 BIRLOS

**No. A.T.V. MF3FAB-C**

**6 CUBO RUEDA DELANTERA**

**C/CONECTOR ABS**

EXPLORER 4x2 / 4x4  
2002 - 2005

AVIATOR 4x2 / 4x4  
2003 - 2006

MOUNTAINEER 4x2 / 4x4  
2002 - 2005



5 BIRLOS

**No. A.T.V. MF4L2Z-C**

El uso de las marcas se hace exclusivamente con el propósito de indicar el modelo al que va destinada cada pieza.

**FORD**

**1 CUBO RUEDA DELANTERA  
P/FRENOS ABS**

EXPLORER 4x2 / 4x4  
2002 - 2005

AVIATOR 4x2 / 4x4  
2003 - 2006

MOUNTAINEER 4x2 / 4x4  
2002 - 2005

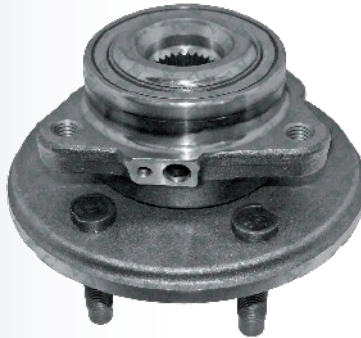

5 BIRLOS

**No. A.T.V. MF4L2Z-S**

**2 CUBO RUEDA DELANTERA**

AEROSTAR 4x4  
1990 - 1997



5 BIRLOS

**No. A.T.V. MF5000**

**3 CUBO RUEDA DELANTERA  
C/CONECTOR ABS**

EXPLORER 4x4  
1995 - 2001

MOUNTAINEER 4x4  
1997 - 2001

VILLAGER 4x4  
1997 - 2002



5 BIRLOS

**No. A.T.V. MF5003-C**

**4 CUBO RUEDA DELANTERA  
P/FRENOS ABS**

EXPLORER 4x4  
1995 - 2001

MOUNTAINEER 4x4  
1997 - 2001

VILLAGER 4x4  
1997 - 2002



5 BIRLOS

**No. A.T.V. MF5003-S**

**5 CUBO RUEDA DELANTERA  
C/CONECTOR ABS**

EXPEDITION 1997 - 2000

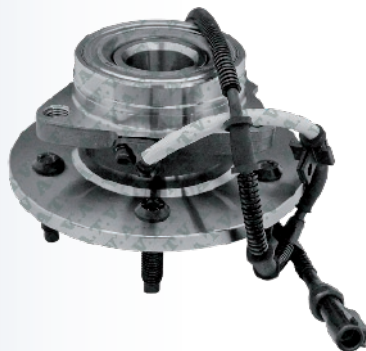

5 BIRLOS M12X1.75mm.

**No. A.T.V. MF5004-C**

**6 CUBO RUEDA DELANTERA  
P/FRENOS ABS**

EXPEDITION 1997 - 2000

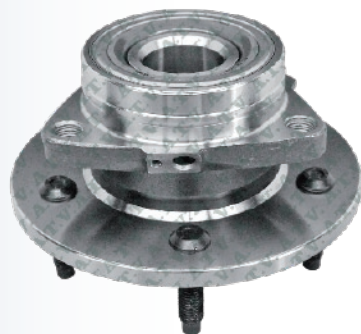

5 BIRLOS M12X1.75mm.

**No. A.T.V. MF5004-S**

El uso de las marcas se hace exclusivamente con el propósito de indicar el modelo al que va destinada cada pieza.



**1 CUBO RUEDA DELANTERA  
C/CONECTOR ABS**

PICK UP F-150 4x4  
1997 - 2000  
LOBO 4x4 1997 - 1999

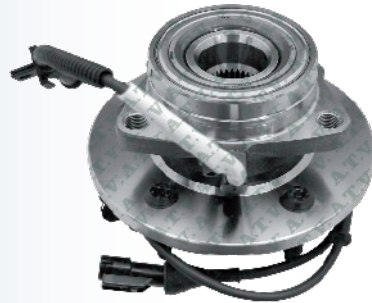

**5 BIRLOS M12X1.75mm.  
No. A.T.V. MF5010-C**

**2 CUBO RUEDA DELANTERA  
P/FRENOS ABS**

PICK UP F-150 4x4  
1997 - 2000  
LOBO 4x4 1997 - 1999

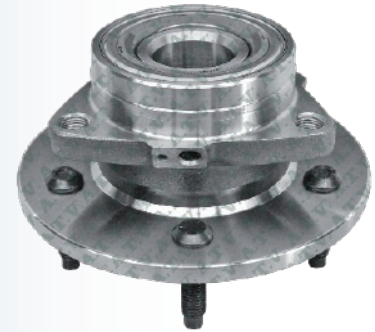

**5 BIRLOS M12X1.75mm.  
No. A.T.V. MF5010-S**

**3 CUBO RUEDA DELANTERA  
C/CONECTOR ABS**

RANGER PICK UP 4x4  
1998 - 2003



**5 BIRLOS DE 1/2" X 20 HILOS  
No. A.T.V. MF5013-C**

**4 CUBO RUEDA DELANTERA  
P/FRENOS ABS**

RANGER PICK UP 4x4  
1998 - 2003



**5 BIRLOS DE 1/2" X 20 HILOS  
No. A.T.V. MF5013-S**

**5 CUBO RUEDA DELANTERA**

RANGER PICK UP 4x4  
2000 - 2002



**5 BIRLOS DE 1/2" X 20 HILOS  
No. A.T.V. MF5014**

**6 CUBO RUEDA DELANTERA**

PICK UP F-150 4x4  
1997 - 2000  
LOBO 4x4 1997 - 1998

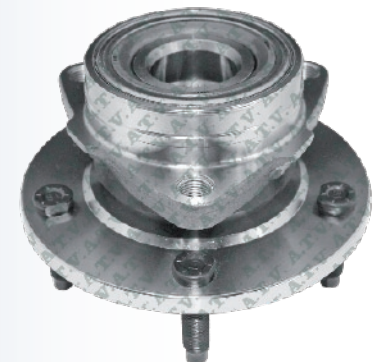

**5 BIRLOS M12X1.75mm.  
No. A.T.V. MF5017**

El uso de las marcas se hace exclusivamente con el propósito de indicar el modelo al que va destinada cada pieza.

**FORD**

**1 CUBO RUEDA DELANTERA  
C/CONECTOR ABS**

EXCURSION  
F-250  
F-350  
F-450

4x4 1999 - 2002

DIESEL / GASOLINA



8 BIRLOS

**No. A.T.V. MF5020-C**

**2 CUBO RUEDA DELANTERA**

EXCURSION  
F-250  
F-350  
F-450

4x4 2000 - 2004

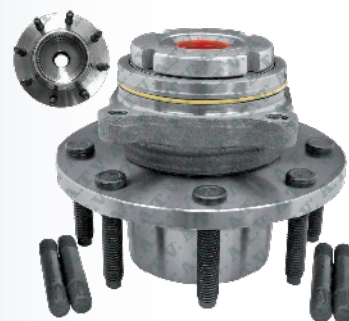

8 BIRLOS

**No. A.T.V. MF5021**

**3 CUBO RUEDA DELANTERA**

PICK UP F-150 4x4  
1986 - 1989

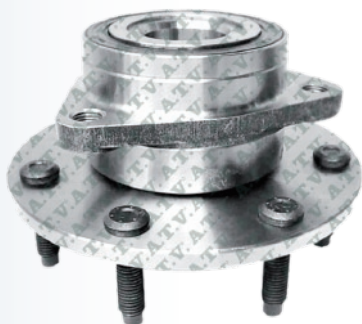

7 BIRLOS M12X1.75mm.

**No. A.T.V. MF5022**

**4 CUBO RUEDA DELANTERA**

RANGER PICK UP 4x4  
1998 - 1999



5 BIRLOS

**No. A.T.V. MF5026**

**5 CUBO RUEDA DELANTERA  
C/CONECTOR ABS**

RANGER PICK UP 4x4  
1998 - 2000



5 BIRLOS

**No. A.T.V. MF5027-C**

**6 CUBO RUEDA DELANTERA**

PICK UP F-150 4x4  
1999 - 2002

LOBO 4x4 1999 - 2004



5 BIRLOS M14X2mm.

**No. A.T.V. MF5028**

El uso de las marcas se hace exclusivamente con el propósito de indicar el modelo al que va destinada cada pieza.

**1 CUBO RUEDA DELANTERA  
C/CONECTOR ABS**

PICK UP F-150 4x4  
1999 - 2002  
LOBO 4x4 2000 - 2004

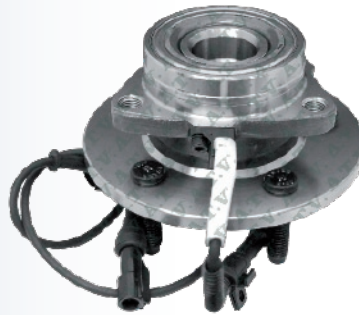

**5 BIRLOS M14X2mm.  
No. A.T.V. MF5029-C**

**2 CUBO RUEDA DELANTERA  
P/FRENOS ABS**

PICK UP F-150 4x4  
1999 - 2002  
LOBO 4x4 2000 - 2004

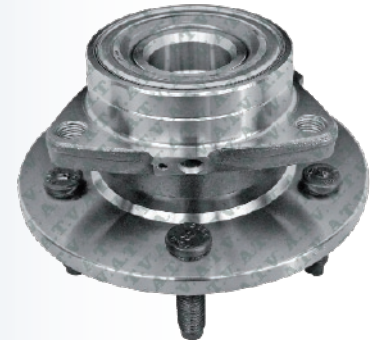

**5 BIRLOS M14X2mm.  
No. A.T.V. MF5029-S**

**3 CUBO RUEDA DELANTERA  
C/CONECTOR ABS**

PICK UP F-150 4x4  
1999 - 2002  
PICK UP F-250 4x4  
1999 - 2002

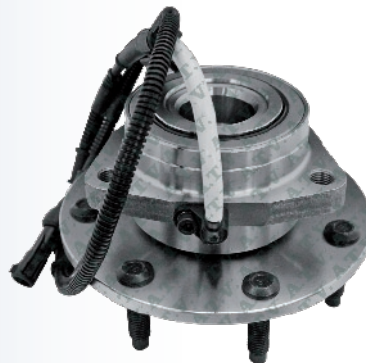

**7 BIRLOS  
No. A.T.V. MF5030-C**

**4 CUBO RUEDA DELANTERA  
P/FRENOS ABS**

PICK UP F-150 4x4  
1999 - 2002  
PICK UP F-250 4x4  
1999 - 2002

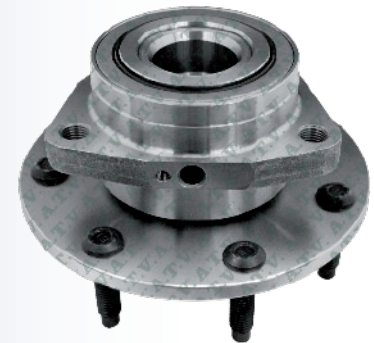

**7 BIRLOS  
No. A.T.V. MF5030-S**

**5 CUBO RUEDA DELANTERA  
C/CONECTOR ABS**

EXPEDITION 4x4  
1997 - 2002  
NAVIGATOR 4x4  
1997 - 2002



**5 BIRLOS M14X1.5mm.  
No. A.T.V. MF5031-C**

**6 CUBO RUEDA DELANTERA  
P/FRENOS ABS**

EXPEDITION 4x4  
1997 - 2002  
NAVIGATOR 4x4  
1997 - 2002

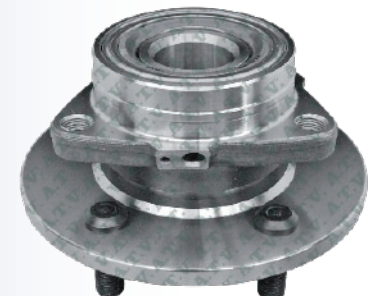

**5 BIRLOS M14X1.5mm.  
No. A.T.V. MF5031-S**

El uso de las marcas se hace exclusivamente con el propósito de indicar el modelo al que va destinada cada pieza.

**FORD**

**1** CUBO RUEDA DELANTERA  
C/CONECTOR ABS

EXPEDITION 4x2  
2003 - 2010

NAVIGATOR 4x2  
2003 - 2010

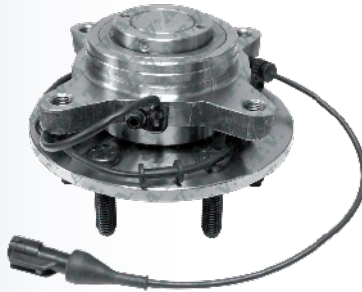

6 BIRLOS

**No. A.T.V. MF5042-C**

**2** CUBO RUEDA DELANTERA  
P/FRENOS ABS

EXPEDITION 4x2  
2003 - 2010

NAVIGATOR 4x2  
2003 - 2010



6 BIRLOS

**No. A.T.V. MF5042-S**

**3** CUBO RUEDA DELANTERA  
C/CONECTOR ABS



EXPLORER SPORT TRAC  
2003 - 2005

RANGER 2003 - 2009

**MAZDA:**  
B3000 2003 - 2007  
B4000 2003 - 2008

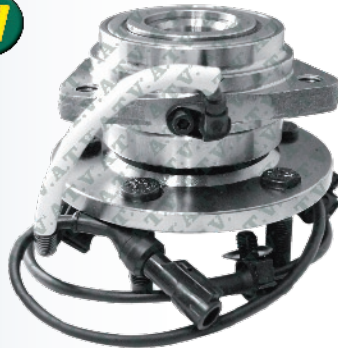

5 BIRLOS

**No. A.T.V. MF5051-C**

**4** CUBO RUEDA DELANTERA  
C/CONECTOR ABS

F-250  
F-350  
F-450  
F-550

SUPER DUTY 4x4  
2002 - 2005

DIESEL / GASOLINA



8 BIRLOS

**No. A.T.V. MF5057-C**

**5** CUBO RUEDA DELANTERA  
C/CONECTOR ABS

EXPLORER 4x2 / 4x4  
2006 >

MOUNTAINEER 4x2 / 4x4  
2006 >



5 BIRLOS

**No. A.T.V. MF5078-C**

**6** CUBO RUEDA DELANTERA  
C/CONECTOR ABS

F-150 4.2LTS V8  
4x4 2004 - 2009

F-250 4.6LTS V8  
4x4 2004 - 2009

F-250 LIGHT DUTY  
4x4 2005 - 2006

LOBO 4.6LTS - 5.4LTS V8  
4x4 2004 - 2009

LINCOLN: MARK LT 2006 >



6 BIRLOS

**No. A.T.V. MF5079-C**

El uso de las marcas se hace exclusivamente con el propósito de indicar el modelo al que va destinada cada pieza.

**1 CUBO RUEDA DELANTERA**

**C/CONECTOR ABS**

F-150 4.2LTS V8  
4x4 2004 - 2009

F-250 4.6LTS V8  
4x4 2004 - 2009

F-250 LIGHT DUTY  
4x4 2005 - 2006

LOBO 4.6LTS - 5.4LTS V8  
4x4 2004 - 2009

LINCOLN: MARK LT 2006 >

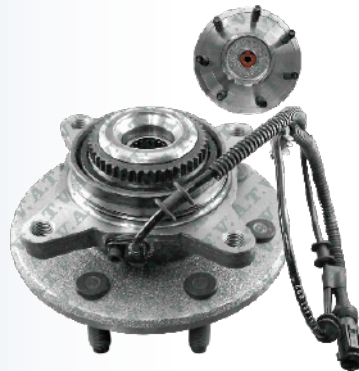

**7 BIRLOS**

**No. A.T.V. MF5080-C**

**2 CUBO RUEDA DELANTERA**

**C/CONECTOR ABS**

F-250 SUPER DUTY  
F-350 SUPER DUTY

4x4 2005 - 2010



**8 BIRLOS / M14X1.5R**

**No. A.T.V. MF5081-C**

**3 CUBO RUEDA DELANTERA**

**C/CONECTOR ABS**

F-250 SUPER DUTY  
4x4 2005 - 2010

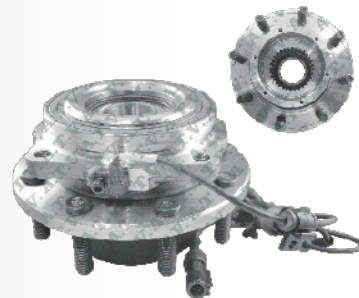

**8 BIRLOS / M14X2R**

**No. A.T.V. MF5082-C**

**4 CUBO RUEDA TRASERA**

**C/CONECTOR ABS**

EXPEDITION  
4x2 / 4x4 2003 - 2006

NAVIGATOR  
4x2 / 4x4 2003 - 2006

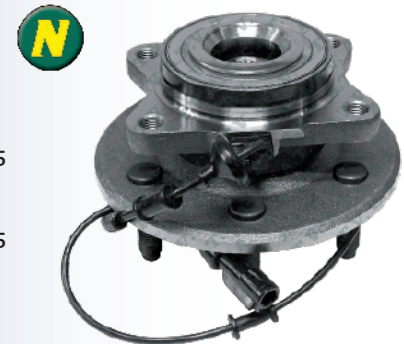

**6 BIRLOS**

**No. A.T.V. MF5410-C**

**5 MAZA RUEDA DELANTERA**

TRANSIT 2007 - 2010



**5 BIRLOS**

**No. A.T.V. MF6525**

**6 KIT MAZA RUEDA DELANTERA**

TRANSIT 2007 - 2010

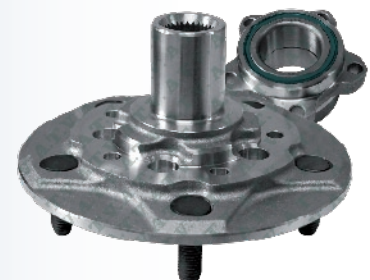

**5 BIRLOS**

**No. A.T.V. MF6525-K**

El uso de las marcas se hace exclusivamente con el propósito de indicar el modelo al que va destinada cada pieza.

**FORD**

**1 MAZA RUEDA DELANTERA**



FUSION 2006 - 2009

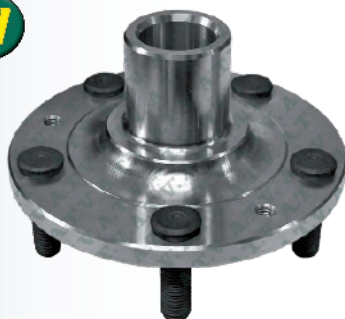

5 BIRLOS

**No. A.T.V. MF6E5Z-B**

**2 KIT MAZA RUEDA DELANTERA**



FUSION 2006 - 2009



5 BIRLOS

**No. A.T.V. MF6E5Z-K**

**3 MAZA (MUÑÓN) TRASERA**

FIESTA 1998 - 2006  
FOCUS 1998 - 2004  
FUSION 2002 - 2006  
IKON 2001 - 2007  
KA 2001 - 2008



**No. A.T.V. MF7314**

**4 KIT REPUESTO MAZA (MUÑÓN) TRASERA**

FIESTA 1998 - 2006



**No. A.T.V. MF7314-RP**

**5 KIT MAZA (MUÑÓN) TRASERA  
CODIFICADOR ABS**

FOCUS 1998 - 2004  
FUSION 2002 - 2006



**No. A.T.V. MF7314-KE**

**6 KIT REPUESTO MAZA (MUÑÓN) TRASERA**

FIESTA 1998 - 2006  
IKON 2001 - 2007  
KA 2001 - 2008



**No. A.T.V. MF9013-RP**

El uso de las marcas se hace exclusivamente con el propósito de indicar el modelo al que va destinada cada pieza.

1 MAZA RUEDA TRASERA

EXPLORER 2002 - 2005



5 BIRLOS

**No. A.T.V. MF9431-B**

KIT MAZA RUEDA TRASERA 2

EXPLORER 2002 - 2005



5 BIRLOS

**No. A.T.V. MF9431-K**

3 CUBO RUEDA TRASERA

MUSTANG 2005 - 2009

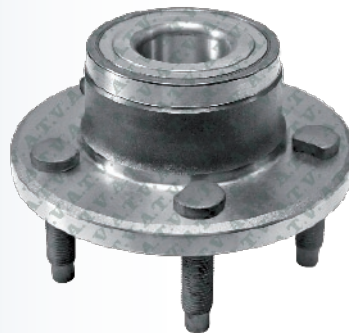

5 BIRLOS

**No. A.T.V. MF9517**

CUBO RUEDA TRASERA 4

P/FRENOS ABS

MUSTANG 2005 - 2009



5 BIRLOS

**No. A.T.V. MF9517-S**

5 MAZA RUEDA DELANTERA

TOPAZ  
ESCORT  
GHIA  
TEMPO

1983 - 1992 MEX.  
1983 - 1990 USA.



4 BIRLOS

**No. A.T.V. MFE3FZ-B**

KIT MAZA RUEDA DELANTERA 6

TOPAZ  
ESCORT  
GHIA  
TEMPO

1983 - 1992 MEX.  
1983 - 1990 USA.

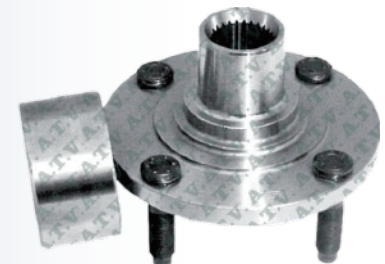

4 BIRLOS

**No. A.T.V. MFE3FZ-K**

El uso de las marcas se hace exclusivamente con el propósito de indicar el modelo al que va destinada cada pieza.

**FORD**

**1 MAZA RUEDA TRASERA**

THUNDERBIRD 1989 - 1997  
COUGAR 1989 - 1997  
LINCOLN MARK 1993 - 1998

TRACCIÓN TRASERA



5 BIRLOS

**No. A.T.V. MFE6DZ-B**

**2 MAZA RUEDA DELANTERA**

LINCOLN CONTINENTAL  
SABLE  
TAURUS

1986 - 1993 MEX.  
1986 - 1991 USA.



5 BIRLOS

**No. A.T.V. MFE6DZ-B**

**3 KIT MAZA RUEDA TRASERA**

COUGAR 1989 - 1997  
THUNDERBIRD 1989 - 1997

TRACCIÓN TRASERA



5 BIRLOS

**No. A.T.V. MFE6DZ-K**

**4 MAZA RUEDA DELANTERA**

ESCORT  
TRACER  
MAZDA: PROTEGE

1995 - 1999 MEX.  
1990 - 1996 USA.



4 BIRLOS

**No. A.T.V. MFF1CZ-B**

**5 KIT MAZA RUEDA DELANTERA**

ESCORT  
TRACER  
MAZDA: PROTEGE

1995 - 1999 MEX.  
1990 - 1996 USA.



4 BIRLOS

**No. A.T.V. MFF1CZ-K**

**6 MAZA RUEDA DELANTERA**

LINCOLN CONTINENTAL  
SABLE  
TAURUS

1991 - 1997 MEX.  
1991 - 1995 USA.

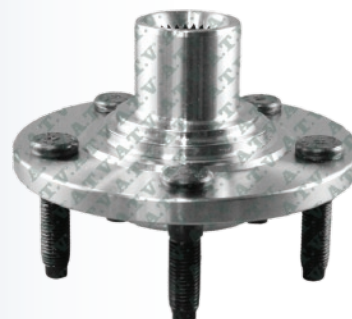

5 BIRLOS

**No. A.T.V. MFF2DZ-B**

El uso de las marcas se hace exclusivamente con el propósito de indicar el modelo al que va destinada cada pieza.



**1 KIT MAZA RUEDA DELANTERA**

LINCOLN CONTINENTAL  
SABLE  
TAURUS

1991 - 1997 MEX.  
1991 - 1995 USA.



5 BIRLOS

**No. A.T.V. MFF2DZ-K**

**2 CUBO RUEDA DELANTERA**

**P/FRENOS ABS**

CROWN VICTORIA  
GRAND MARQUIS  
LINCOLN TOWN CAR

1992 -  
HASTA MARZO DE 1997



5 BIRLOS

**No. A.T.V. MFF5AZ-S**

**3 MAZA RUEDA DELANTERA**

CONTOUR  
COUGAR  
MYSTIQUE

1995 - 2000  
TRACCIÓN DELANTERA



4 BIRLOS

**No. A.T.V. MFF5RZ-B**

**4 KIT MAZA RUEDA DELANTERA**

CONTOUR  
COUGAR  
MYSTIQUE

1995 - 2000  
TRACCIÓN DELANTERA

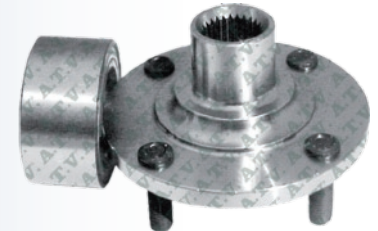

4 BIRLOS

**No. A.T.V. MFF5RZ-K**

**5 MAZA RUEDA DELANTERA**

WINDSTAR 1995 - 2000



5 BIRLOS

**No. A.T.V. MFF68Z-B**

**6 KIT MAZA RUEDA DELANTERA**

WINDSTAR 1995 - 2000



5 BIRLOS

**No. A.T.V. MFF68Z-K**

El uso de las marcas se hace exclusivamente con el propósito de indicar el modelo al que va destinada cada pieza.

Aplicable a:

# FORD

## 1 MAZA RUEDA DELANTERA 31 ESTRIAS



MAZDA:  
CX-7 2007 >

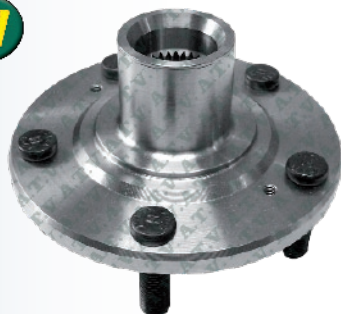

5 BIRLOS

**No. A.T.V. MFL206-B**

## 2 KIT MAZA RUEDA DELANTERA 31 ESTRIAS



MAZDA:  
CX-7 2007 >

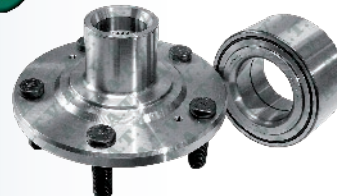

5 BIRLOS

**No. A.T.V. MFL206-K**

## 3 CUBO RUEDA TRASERA

ESCORT  
TRACER  
MAZDA: PROTEGE

1990 - 1998 MEX.  
1990 - 1996 USA.

COURIER < 2005

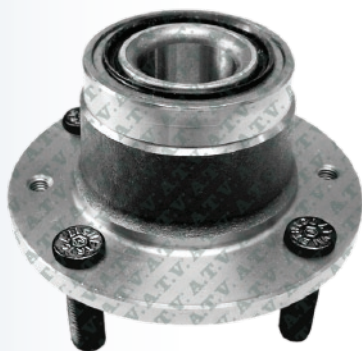

4 BIRLOS

**No. A.T.V. MFV053**

## 4 CUBO RUEDA TRASERA P/FRENOS ABS

ESCORT  
TRACER  
MAZDA: PROTEGE

1990 - 1998 MEX.  
1990 - 1996 USA.

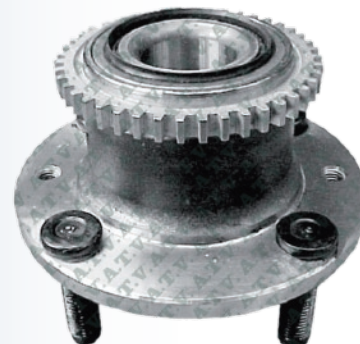

4 BIRLOS

**No. A.T.V. MFV053-S**

El uso de las marcas se hace exclusivamente con el propósito de indicar el modelo al que va destinada cada pieza.

**1 CUBO RUEDA DELANTERA**

CENTURY  
CELEBRITY  
CUTLASS  
CITATION

1982 - 1989 MEX.  
1983 - 1989 USA.

SKYLARK 1980 - 1985



5 BIRLOS

**No. A.T.V. MG0002**

**2 CUBO RUEDA DELANTERA**

CENTURY, CUTLASS, CIERA,  
CRUSIER, EUROSPOORT,  
1990 - 1993  
CELEBRITY, SILHOUETTE VAN,  
TRANS SPORT VAN 6000,  
PARK AVENUE 1990 - 1991  
ELECTRA, FLEETWOOD,  
DEVILLE, NINETHY EIGHT  
1985 - 1991  
LESABRE 1986 - 1991  
BONNEVILLE 1987 - 1991  
RIVIERA, REATTA, SEVILLE,  
EL DORADO, TORONADO  
1986 - 1988  
DELTA 88 1986 - 1989  
LUMINA APV, EIGHTY EIGHT  
1990 - 1991



5 BIRLOS

**No. A.T.V. MG0003**

**3 CUBO RUEDA DELANTERA**

CAVALIER  
CUTLASS  
BERETTA  
CALAIS  
CORSICA  
GRAND AM  
INTERNATIONAL  
SUNBIRD  
1985 - 1995

CIMARRON 1984 - 1988  
SKYHAWK 1984 - 1998  
SKYLARK 1986 - 1998  
SUNFIRE 1999 - 2000



5 BIRLOS

**No. A.T.V. MG0004**

**4 CUBO RUEDA DELANTERA**

S-10 BLAZER  
SERIE S-10  
4x4 1990 - 1994

ASTRO  
LUMINA APV  
4x4 1983 - 1989

RIVIERA  
TORONADO  
EL DORADO  
SEVILLE  
1980 - 1985



5 BIRLOS

**No. A.T.V. MG0005**

**5 CUBO RUEDA DELANTERA**

CAVALIER L4 1990 - 2002  
CAVALIER V6 1990 - 1994

CUTLASS SUPREME  
GRAND PRIX  
REGAL  
1988 - 1996

LUMINA 1996 - 2000

MONTECARLO 1990 - 1999

SUNBIRD 1985 - 1996

SUNFIRE 16 VAL. 1997



5 BIRLOS

**No. A.T.V. MG0007**

**6 CUBO RUEDA DELANTERA**

CAVALIER  
BERETTA  
CORSICA  
GRAND AM  
SKYLARK  
SUNBIRD

1996 - 2002 MEX.  
1991 - 1996 USA.



5 BIRLOS

**No. A.T.V. MG0014**

El uso de las marcas se hace exclusivamente con el propósito de indicar el modelo al que va destinada cada pieza.

# GENERAL MOTORS

## 1 CUBO RUEDA DELANTERA

ASTRA 1998 - 2005  
ZAFIRA 1999 - 2005

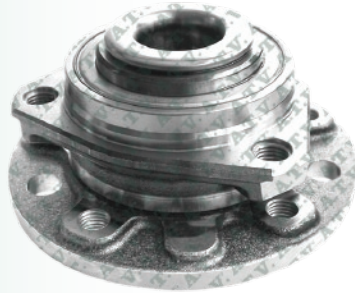

4 ROSCAS

**No. A.T.V. MG0048**

## 2 CUBO RUEDA DELANTERA

ASTRA 1998 - 2005  
ZAFIRA 1999 - 2005

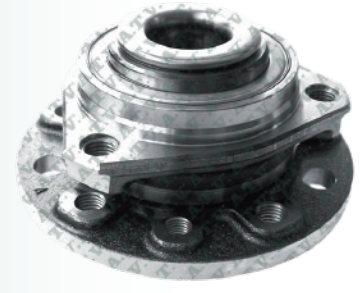

5 ROSCAS

**No. A.T.V. MG0053**

## 3 CUBO RUEDA TRASERA

ASTRA 1998 - 2005  
ASTRA 1.8 16 V COUPE  
2000 - 2002  
ASTRA 2.0LT  
DTI 16V  
1998 - 2002  
ZAFIRA 1999 - 2005

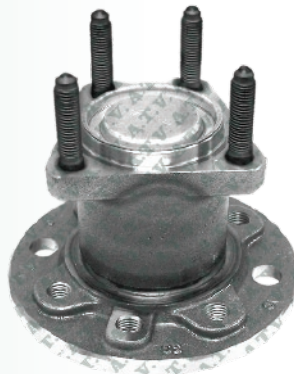

5 ROSCAS

**No. A.T.V. MG0066**

## 4 CUBO RUEDA TRASERA

C/CONECTOR ABS

VECTRA 2002 - 2008  
SAAB: 9-3 2002 - 2008

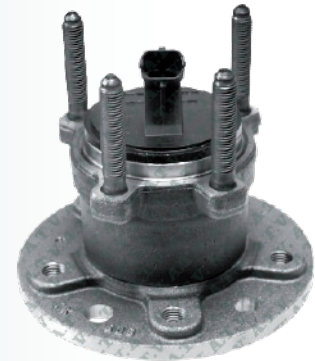

5 ROSCAS

**No. A.T.V. MG0084-C**

## 5 CUBO RUEDA TRASERA

ASTRA 2000 - 2004  
MERIVA 2003 - 2008  
TORNADO 2004 >  
ZAFIRA 2000 - 2004



4 ROSCAS

**No. A.T.V. MG0129**

## 6 CUBO RUEDA DELANTERA

C/CONECTOR ABS

UPLANDER 2006  
MONTANA SV6  
2005 - 2006



6 BIRLOS

**No. A.T.V. MG0131-C**

El uso de las marcas se hace exclusivamente con el propósito de indicar el modelo al que va destinada cada pieza.

**1 CUBO RUEDA DELANTERA  
C/CONECTOR ABS**

BLAZER  
BLAZER TRK  
ENVOY

4x2 1998 - 2001

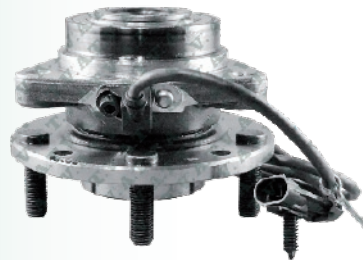

5 BIRLOS

**No. A.T.V. MG0157-C**

**2 CUBO RUEDA DELANTERA  
P/FRENOS ABS**

BLAZER  
BLAZER TRK  
ENVOY

4x2 1998 - 2001

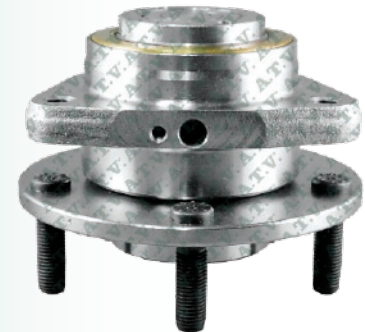

5 BIRLOS

**No. A.T.V. MG0157-S**

**3 CUBO RUEDA DELANTERA  
C/CONECTOR ABS  
30 ESTRÍAS**



EQUINOX 2007 - 2010  
CAPTIVA 2008 - 2010  
TERRAIN 2010 >  
TORRENT 2007 - 2009  
SATURN VUE 2008 - 2009



5 BIRLOS

**No. A.T.V. MG0262-C**

**4 CUBO RUEDA DELANTERA  
C/CONECTOR ABS**

COLORADO  
CANYON

4x4

2004 - 2008

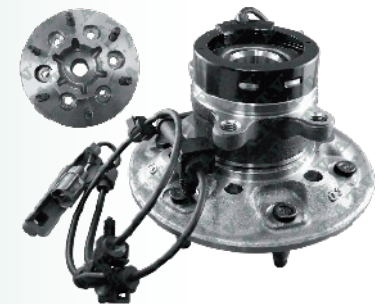

6 BIRLOS

**No. A.T.V. MG0274-C**

**5 CUBO RUEDA DELANTERA  
C/ENCODER INTEGRADO**

COLORADO  
CANYON

4x4

2004 - 2008

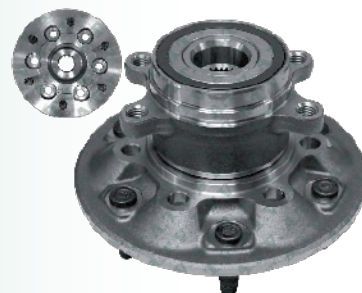

6 BIRLOS

**No. A.T.V. MG0274-S**

**6 CUBO RUEDA DELANTERA  
C/CONECTOR ABS**

SILVERADO 1500  
SILVERADO 2500  
AVALANCHE 4WD  
SIERRA 4WD  
4x4 2001 - 2004

ESCALADE 4WD  
ESCALADE EXT  
4x4 2002 - 2004

H1500  
H2500  
4x4 2003 - 2004

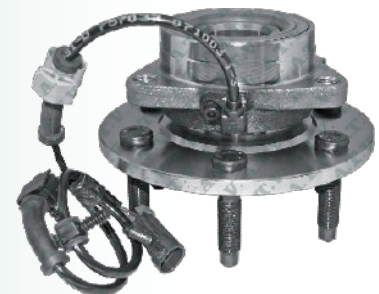

6 BIRLOS

**No. A.T.V. MG0291-C**

El uso de las marcas se hace exclusivamente con el propósito de indicar el modelo al que va destinada cada pieza.

# GENERAL MOTORS

## 1 CUBO RUEDA DELANTERA

**P/FRENOS ABS**

SILVERADO 1500  
SILVERADO 2500  
AVALANCHE 4WD  
SIERRA 4WD  
4x4 2001 - 2004

ESCALADE 4WD  
ESCALADE EXT  
4x4 2002 - 2004

H1500  
H2500  
4x4 2003 - 2004



6 BIRLOS

**No. A.T.V. MG0291-S**

## 2 CUBO RUEDA DELANTERA

**C/CONECTOR ABS  
HORQUILLA SIN ROSCA**

CENTURY, CUTLASS,  
SILHOUETTE, CONCOURS,  
CIMARRON, AURORA,  
SEVILLE, FLEETWOOD  
1994 - 1996

PARK AVENUE, ALLANTE,  
EL DORADO, RIVIERA,  
LUMINA APV,  
TRANS SPORT,  
NINETY EIGHT  
1992 - 1996

LESABRE, BONNEVILLE,  
EIGHTY EIGHT 1992 - 1999  
TORONADO 1992



5 BIRLOS

**No. A.T.V. MG0511-C**

## 3 CUBO RUEDA DELANTERA

**C/CONECTOR ABS**

COLORADO  
CANYON

**4x2**

2004 - 2008

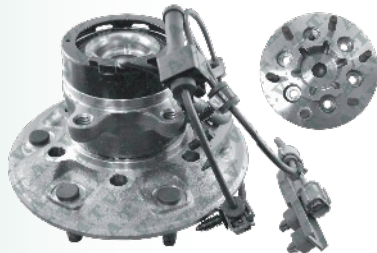

6 BIRLOS

**No. A.T.V. MG0661-C**

## 4 CUBO RUEDA DELANTERA

**C/ENCODER INTEGRADO**

COLORADO  
CANYON

**4x2**

2004 - 2008



6 BIRLOS

**No. A.T.V. MG0661-S**

## 5 CUBO RUEDA DELANTERA

**P/FRENOS ABS  
CON REJILLA SENSORA**

TRACKER 4x4 1999 - 2004

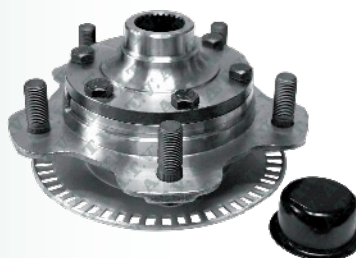

5 BIRLOS

**No. A.T.V. MG0930-S**

## 6 CUBO RUEDA DELANTERA

**C/CONECTOR ABS**

EXPRESS VAN 4x2  
2001 - 2009



8 BIRLOS

**No. A.T.V. MG1148-C**

El uso de las marcas se hace exclusivamente con el propósito de indicar el modelo al que va destinada cada pieza.

**1 CUBO RUEDA DELANTERA**

**P/FRENOS ABS**

EXPRESS VAN 4x2  
2001 - 2009



8 BIRLOS

**No. A.T.V. MG1148-S**

**2 CUBO RUEDA DELANTERA**

**C/CONECTOR ABS**

TRAIL BLAZER 4x2 / 4x4  
2002 - 2007



6 BIRLOS

**No. A.T.V. MG1241-C**

**3 CUBO RUEDA TRASERA**

**C/CONECTOR ABS**

EQUINOX 4x2 / 4x4  
2005 - 2008



5 BIRLOS

**No. A.T.V. MG1427-C**

**4 CUBO RUEDA TRASERA**

**C/CONECTOR ABS**

MALIBU 1997 - 2000  
PARK AVENUE 1997 - 2000  
GRAND AM 1990 - 2000  
EL DORADO 1991 - 1992  
ALLANTE 1991 - 1992  
TORONADO 1991 - 1992  
RIVIERA 1991 - 1999  
BONNEVILLE SLE GPX  
2004 - 2005  
BONNEVILLE 2000 - 2003  
AURORA 1995 - 2000  
SEVILLE 1998 - 2000  
LESABRE 2000  
DEVILLE 2000

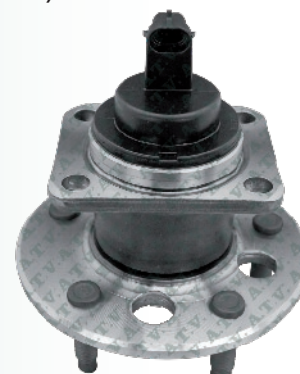

5 BIRLOS

**No. A.T.V. MG2003-C**

**5 CUBO RUEDA TRASERA**

**C/CONECTOR ABS**

CUTLASS SUPREME  
GRAND PRIX  
LUMINA  
MONTECARLO  
REGAL  
  
1992 - 1996

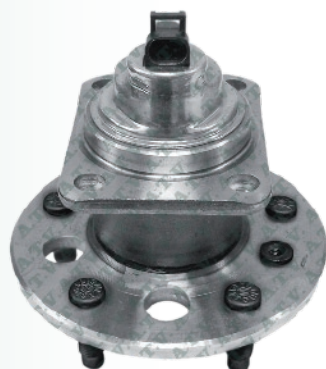

5 BIRLOS

**No. A.T.V. MG2004-C**

**6 CUBO RUEDA TRASERA**

**C/CONECTOR ABS**

VENTURE 1992 - 2005  
CENTURY 1994 - 1996  
LUMINA APV 1992 - 1997  
SILHOUETTE 1992 - 1997  
TRANS SPORT 1992 - 2000  
(FRENO DE TAMBOR)  
  
CIERA 1994 - 1996  
CUTLASS 1994  
MONTANA 1999 - 2000

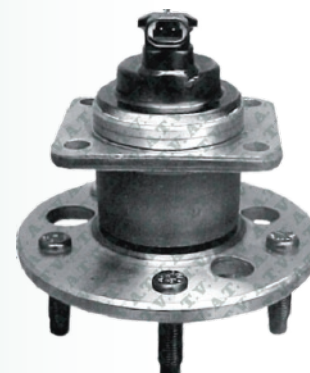

5 BIRLOS

**No. A.T.V. MG2078-C**

El uso de las marcas se hace exclusivamente con el propósito de indicar el modelo al que va destinada cada pieza.

# GENERAL MOTORS

## 1 CUBO RUEDA TRASERA C/CONECTOR ABS

IMPALA 2000 C/FRENO  
TRASERO DE TAMBOR  
GRAND PRIX 1997 - 2003  
AZTEK 2001 - 2005

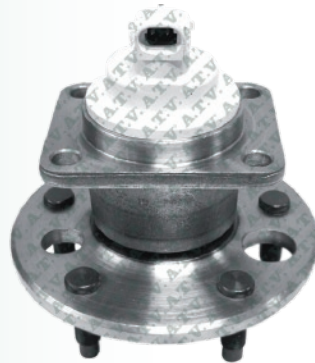

5 BIRLOS

**No. A.T.V. MG2150-C**

## 2 CUBO RUEDA TRASERA C/CONECTOR ABS

LUMINA 1995 - 1997



5 BIRLOS

**No. A.T.V. MG2151-C**

## 3 CUBO RUEDA TRASERA C/CONECTOR ABS

GRAND AM GT  
2001 - 2002



5 BIRLOS

**No. A.T.V. MG2152-C**

## 4 CUBO RUEDA TRASERA C/CONECTOR ABS

CORVETTE 1997 - 2002



5 BIRLOS

**No. A.T.V. MG2153-C**

## 5 CUBO RUEDA TRASERA C/CONECTOR ABS DER/IZQ

VIBE 2003 - 2004

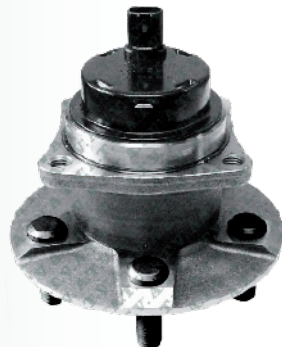

5 BIRLOS

**No. A.T.V. MG2215-C**

## 6 CUBO RUEDA TRASERA

CENTURY 2004 - 2005  
IMPALA 2000 - 2004  
REGAL 2003 - 2004  
GRAND PRIX 2003  
AZTEK 2003 - 2004

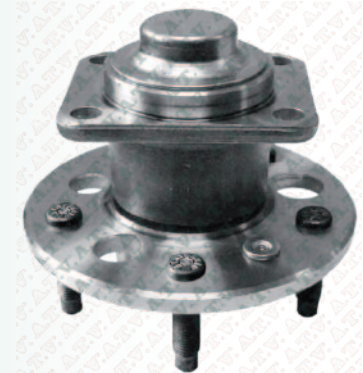

5 BIRLOS

**No. A.T.V. MG2221**

El uso de las marcas se hace exclusivamente con el propósito de indicar el modelo al que va destinada cada pieza.



1

**CUBO RUEDA TRASERA**

**C/CONECTOR ABS**



UPLANDER 2006>



6 BIRLOS

**No. A.T.V. MG2308-C**

**CUBO RUEDA TRASERA**

2

**C/CONECTOR ABS**

CUTLASS SUPREME  
GRAND PRIX  
REGAL

1988 - 1991



5 BIRLOS

**No. A.T.V. MG3042-C**

3

**CUBO RUEDA DELANTERA**

**P/FRENOS ABS**

5-10 BLAZER  
5-10 PICK UP  
5-15 JIMMY  
4x4 1990 - 1996

5-15 TYPHOON 4x4  
1992 - 1993

5-15 SYCLONE 4x4 1991  
5-15 SONOMA  
BRAVADA  
4x4 1991 - 1996

5-15 PICK UP 4x4 1990  
IZUZU HOMBRE 4x4  
1996 - 1998



5 BIRLOS

**No. A.T.V. MG3061-S**

**CUBO RUEDA TRASERA**

4

**C/CONECTOR ABS**

LESABRE  
DELTA 88  
BONNEVILLE  
1991 - 1999

REGENCY 1998

DEVILLE  
FLEETWOOD  
OLDSMOBILE 98  
PARK AVENUE  
1991 - 1993

GRAND PRIX 1997



5 BIRLOS

**No. A.T.V. MG3062-C**

5

**CUBO RUEDA DELANTERA**

BONNEVILLE 1992  
BUICK LESABRE 1992  
EIGHTY EIGHT 1992

DEVILLE 1992 - 1993  
FLEETWOOD 1992 - 1993

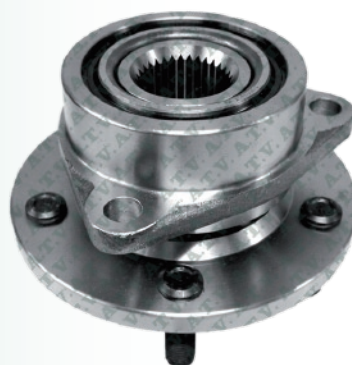

5 BIRLOS

**No. A.T.V. MG3088**

**CUBO RUEDA DELANTERA**

6

**C/CONECTOR ABS**

CAMARO  
FIREBIRD  
TRANS AM

1993 - 2000



5 BIRLOS

**No. A.T.V. MG3090-C**

El uso de las marcas se hace exclusivamente con el propósito de indicar el modelo al que va destinada cada pieza.

# GENERAL MOTORS

## 1 CUBO RUEDA DELANTERA

88 ROYALE, 98 REGENCY  
BRAVADA, CENTURY  
CUTLASS CIERA, DEVILLE  
EL DORADO, GRAND PRIX  
LUMINA APV, PARK AVENUE  
REGAL, RIVIERA, SEVILLE,  
SILHOUETTE, TRANS SPORT  
VAN, VENTURE  
1997 - 2000

MONTECARLO, AURORA,  
BONNEVILLE, 1997 - 2001

IMPALA 2000  
GRAND AM 1998  
AZTEK 2000 >

**C/CONECTOR ABS  
HORQUILLA CON ROSCA**



5 BIRLOS

**No. A.T.V. MG3121-C**

## 2 CUBO RUEDA DELANTERA

BRAVADA  
SILHOUETTE  
5-15 PICK UP  
4x4 1997 - 2000

5-10 BLAZER  
4x4 1997 - 2001

**C/CONECTOR ABS**



5 BIRLOS

**No. A.T.V. MG3124-C**

## 3 CUBO RUEDA DELANTERA

BRAVADA  
SILHOUETTE  
5-15 PICK UP  
4x4 1997 - 2000

5-10 BLAZER  
4x4 1997 - 2001

**P/FRENOS ABS**



5 BIRLOS

**No. A.T.V. MG3124-S**

## 4 CUBO RUEDA DELANTERA

MALIBU  
ALERO  
GRAND AM  
1999 - 2001

**C/CONECTOR ABS  
HORQUILLA CON ROSCA**



5 BIRLOS

**No. A.T.V. MG3137-C**

## 5 CUBO RUEDA DELANTERA

CORVETTE 1997 - 2005

**C/CONECTOR ABS**



5 BIRLOS

**No. A.T.V. MG3139-C**

## 6 CUBO RUEDA DELANTERA

VENTURE 4x4  
2001 - 2004

UPLANDER 4x4  
2005 - 2006

SILHOUETTE 4x4  
2002 - 2004

**C/CONECTOR ABS**



5 BIRLOS

**No. A.T.V. MG3187-C**

El uso de las marcas se hace exclusivamente con el propósito de indicar el modelo al que va destinada cada pieza.

**1 CUBO RUEDA DELANTERA**

**SIN ABS**

AZTEK 2001 - 2005  
VENTURE 2003 - 2005  
GRAND PRIX 2003 - 2008  
MONTANA 2003 - 2005  
IMPALA 2000 - 2008  
MONTECARLO 2000 - 2007  
ALLURE 2005 - 2007  
LACROSSE 2005 - 2007  
CENTURY 2003 - 2005  
REGAL 2003 - 2004  
RENDEZVOUS 2003 - 2007



5 BIRLOS

**No. A.T.V. MG3203**

**2 CUBO RUEDA DELANTERA**

**C/CONECTOR ABS**

MALIBU 4x2  
2004 - 2007

G6 4x2 2005 - 2007



5 BIRLOS

**No. A.T.V. MG3213-C**

**3 CUBO RUEDA DELANTERA**

K2500  
SUBURBAN  
4x4 1988 - 1994

K1500  
HEAVY DUTY  
4x4 1988 - 1991



6 BIRLOS

**No. A.T.V. MG5001**

**4 CUBO RUEDA DELANTERA**

K1500 4x4 1988 - 1991  
LIGHT DUTY C-1500

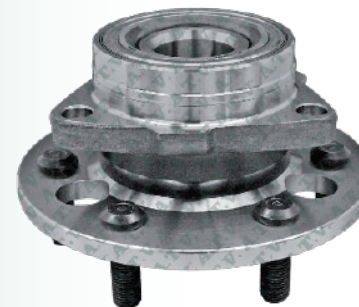

6 BIRLOS

**No. A.T.V. MG5002**

**5 CUBO RUEDA DELANTERA**

**C/CONECTOR ABS**

ASTRO VAN 4x4  
1990 - 1994

SAFARI VAN 4x4  
1990 - 1994



5 BIRLOS

**No. A.T.V. MG5005-C**

**6 CUBO RUEDA DELANTERA**

TYK SUBURBAN  
K2500  
HEAVY DUTY

4x4 1995 - 1998

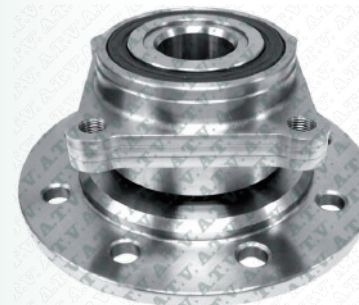

P/8 BIRLOS

**No. A.T.V. MG5018**

El uso de las marcas se hace exclusivamente con el propósito de indicar el modelo al que va destinada cada pieza.

# GENERAL MOTORS

## 1 CUBO RUEDA DELANTERA C/CONECTOR ABS

ASTRO VAN 4x4  
1995 - 2001  
  
SAFARI 4x4  
1995 - 2001



5 BIRLOS

**No. A.T.V. MG5019-C**

## 2 CUBO RUEDA DELANTERA C/CONECTOR ABS

SUBURBAN  
SUBURBAN C-1500  
YUKON  
TAHOE  
CHEVROLET K1500  
4x4 1995 - 2000  
  
ESCALADE EXT 4x4  
1999 - 2000



6 BIRLOS

**No. A.T.V. MG5024-C**

## 3 CUBO RUEDA DELANTERA P/FRENOS ABS

SUBURBAN  
SUBURBAN C-1500  
YUKON  
TAHOE  
CHEVROLET K1500  
4x4 1995 - 2000  
  
ESCALADE EXT 4x4  
1999 - 2000

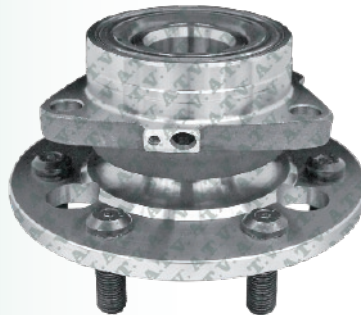

6 BIRLOS

**No. A.T.V. MG5024-S**

## 4 CUBO RUEDA DELANTERA C/CONECTOR ABS

K-1500  
K-2500  
K-3500  
4x4 1996 - 2000

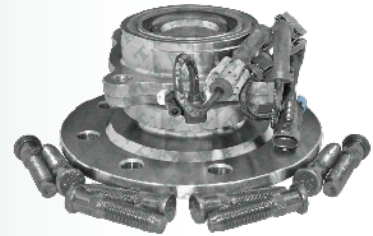

8 BIRLOS

**No. A.T.V. MG5041-C**

## 5 CUBO RUEDA DELANTERA P/FRENOS ABS

K-1500  
K-2500  
K-3500  
4x4 1996 - 2000

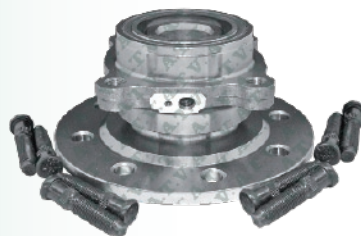

8 BIRLOS

**No. A.T.V. MG5041-S**

## 6 CUBO RUEDA DELANTERA C/CONECTOR ABS

GMC C-3500 4x4  
1996 - 2000  
  
SUBURBAN K-2500 4x4  
1996 - 2000

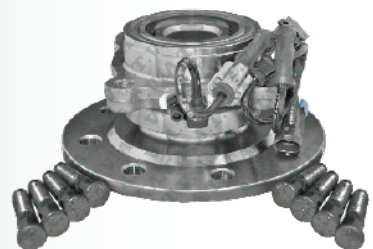

8 BIRLOS

**No. A.T.V. MG5055-C**

El uso de las marcas se hace exclusivamente con el propósito de indicar el modelo al que va destinada cada pieza.

**GENERAL MOTORS**

**1 CUBO RUEDA DELANTERA**

**P/FRENOS ABS**

GMC C-3500 4x4  
1996 - 2000

SUBURBAN K2500 4x4  
1996 - 2000

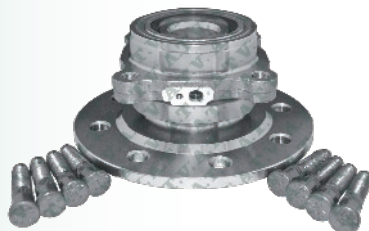

8 BIRLOS

**No. A.T.V. MG5055-S**

**2 CUBO RUEDA DELANTERA**

**C/CONECTOR ABS**

**HUMMER:**  
H2 2003 - 2007

YUKON XL 2500  
2000 - 2007

SILVERADO 2500, 3500  
2500 HEAVY DUTY  
SUBURBAN  
TAHOE  
AVALANCHE  
4x4 2001 - 2005

SIERRA  
4x4 1999 - 2005



8 BIRLOS

**No. A.T.V. MG5058-C**

**3 CUBO RUEDA DELANTERA**

**P/FRENOS ABS**

**HUMMER:**  
H2 2003 - 2007

YUKON XL 2500  
2000 - 2007

SILVERADO 2500, 3500  
2500 HEAVY DUTY  
SUBURBAN  
TAHOE  
AVALANCHE  
4x4 2001 - 2005

SIERRA  
4x4 1999 - 2005

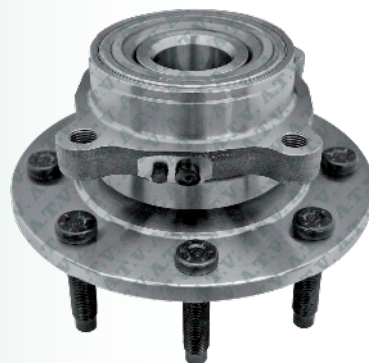

8 BIRLOS

**No. A.T.V. MG5058-S**

**4 CUBO RUEDA DELANTERA/TRASERA**

**C/ENCODER INTEGRADO**

ACADIA 2007 - 2011  
TRAVERSE 2009 - 2011

**BUICK:**  
ENCLAVE 2008 - 2011

**SATURN:**  
OUTLOOK 2007 - 2010

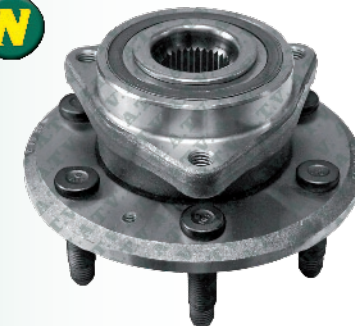

6 BIRLOS

**No. A.T.V. MG5059-E**

**5 CUBO RUEDA DELANTERA**

**C/CONECTOR ABS**

HHR 2006 - 2009

G4 2005 - 2006  
G5 2007 - 2008

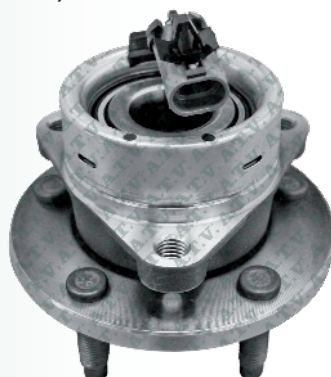

5 BIRLOS

**No. A.T.V. MG5554-C**

**6 MAZA RUEDA DELANTERA**

ASTRA 1.8 L, 2.0 L  
2000 - 2003

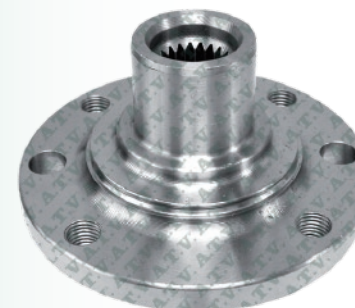

4 ROSCAS

**No. A.T.V. MG5583**

El uso de las marcas se hace exclusivamente con el propósito de indicar el modelo al que va destinada cada pieza.

# GENERAL MOTORS

## 1 KIT MAZA RUEDA DELANTERA

ASTRA 1.8L, 2.0L  
2000 - 2003



4 ROSCAS

**No. A.T.V. MG5583-K**

## 2 CUBO RUEDA DELANTERA

TRACKER 2001 - 2005



5 BIRLOS

**No. A.T.V. MG5890**

## 3 CUBO RUEDA DELANTERA

C/CONECTOR ABS

ASTRA 1998 - 2005  
ZAFIRA 1999 - 2005



4 ROSCAS

**No. A.T.V. MG620A-C**

## 4 CUBO RUEDA DELANTERA

C/CONECTOR ABS

VECTRA 1.8 L, 2.0 L  
2003 - 2006

CADILLAC BLS  
2005 - 2007

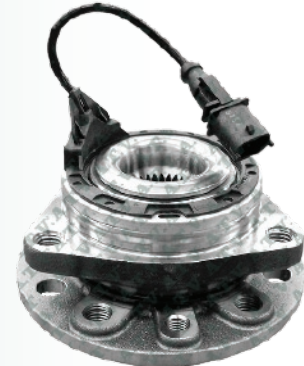

5 ROSCAS

**No. A.T.V. MG6387-C**

## 5 CUBO RUEDA DELANTERA

C/CONECTOR ABS

SILVERADO C-3500 C36  
4x2 2001 - 2007

MOTOR VORTEC  
DOBLE RODADA



8 BIRLOS

**No. A.T.V. MG6753-C**

## 6 CUBO RUEDA DELANTERA

P/FRENOS ABS

SILVERADO C-3500 C36  
4x2 2001 - 2007

MOTOR VORTEC  
DOBLE RODADA

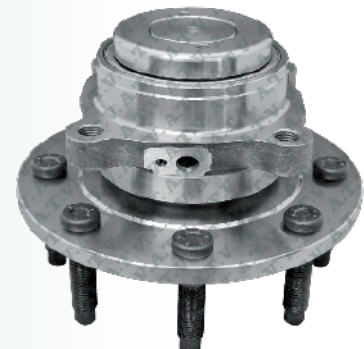

8 BIRLOS

**No. A.T.V. MG6753-S**

El uso de las marcas se hace exclusivamente con el propósito de indicar el modelo al que va destinada cada pieza.

**1 MAZA RUEDA DELANTERA**

MERIVA 2003 - 2008  
CORSA 2002 - 2008

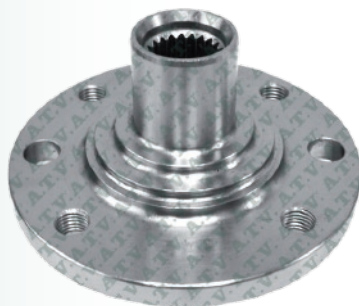

4 ROSCAS

**No. A.T.V. MG6767**

**KIT MAZA RUEDA DELANTERA 2**

MERIVA 2003 - 2008  
CORSA 2002 - 2008

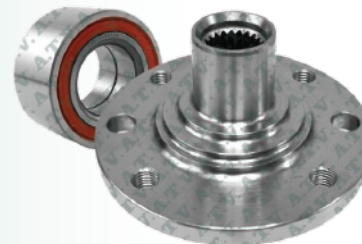

4 ROSCAS

**No. A.T.V. MG6767-K**

**3 CUBO RUEDA TRASERA**

SKYHAWK 1980 - 1990  
SOMERSET 1980 - 1990

CIMARRON 1982 - 1988

BERETTA, SKYLARK,  
CAVALIER, CITATION,  
CORSICA, CUTLASS  
CALAIS, FIRENZA, OMEGA,  
GRAND AM, SUNBIRD,  
TEMPEST, J2000,  
PHOENIX  
1980 - 1991



5 BIRLOS

**No. A.T.V. MG6906**

**CUBO RUEDA TRASERA 4**

CENTURY  
CELEBRITY  
CUTLASS  
CITATION

1982 - 1989 MEX  
1983 - 1989 USA

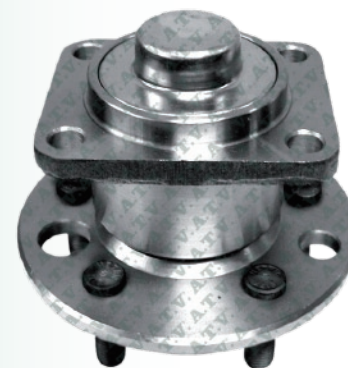

5 BIRLOS

**No. A.T.V. MG6916**

**5 CUBO RUEDA TRASERA**

CENTURY, CUTLASS, CIERA,  
CRUSIER, EUROSPORT,  
1989 - 1993

CELEBRITY, SILHOUETTE,  
TRANS SPORT 1990 - 1991

EL DORADO, SEVILLE,  
DELTA88, RIVIERA,

TORONADO, 1986 - 1990

DEVILLE, FLEETWOOD  
1985 - 1993

ELECTRA 1985 - 1992

PARK AVENUE 1991 - 1992

LESABRE 1988 - 1992

REGAL 1988 - 1993

REATA 1988 - 1990

BONNEVILLE 1987-1992 EIGHTY

EIGHT 1987-1992

GRAND PRIX 1987 - 1996

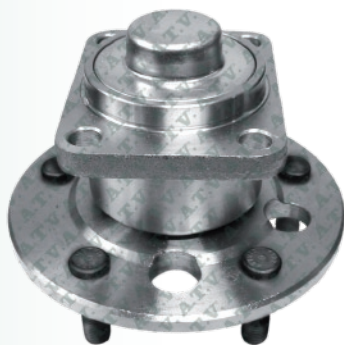

5 BIRLOS

**No. A.T.V. MG6918**

**CUBO RUEDA TRASERA 6**

**C/CONECTOR ABS**

CAVALIER 1991 - 2004

SUNFIRE 1992 - 2002

BERETTA 1991 - 1998

SKYLARK 1991 - 1998

CORSICA 1992 - 2000

GRAND AM 1991 - 2000



5 BIRLOS

**No. A.T.V. MG6970-C**

El uso de las marcas se hace exclusivamente con el propósito de indicar el modelo al que va destinada cada pieza.

# GENERAL MOTORS

## 1 CUBO RUEDA DELANTERA

SILVERADO 1500/2500  
1999 - 2008  
CHEYENNE 1500/2500  
1999-2005

**C/CONECTOR ABS**

SIERRA  
SONORA  
SUBURBAN  
TAHOE  
YUKON  
4x2 2001 - 2008

EXPRESS VAN 1500-2500  
4x2 2003-2008



6 BIRLOS

**No. A.T.V. MG7207-C**

## 2 CUBO RUEDA DELANTERA

SILVERADO 1500/2500  
1999 - 2008  
CHEYENNE 1500/2500  
1999-2005

**P/FRENOS ABS**

SIERRA  
SONORA  
SUBURBAN  
TAHOE  
YUKON  
4x2 2001 - 2008

EXPRESS VAN 1500-2500  
4x2 2003-2008



6 BIRLOS

**No. A.T.V. MG7207-S**

## 3 CUBO RUEDA DELANTERA

**C/CONECTOR ABS**

ASTRA 2000 - 2005  
ZAFIRA 2000 - 2005



5 ROSCAS

**No. A.T.V. MG7622-C**

## 4 MAZA RUEDA DELANTERA

CHEVY:  
JOY  
MONZA  
POP  
SWING  
1994 - 2003

CHEVY PICK UP  
1999 - 2003

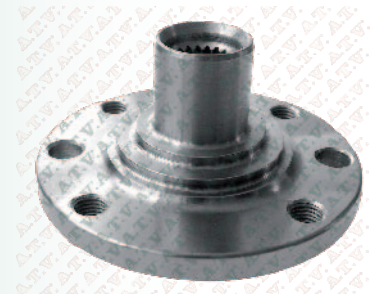

4 ROSCAS

**No. A.T.V. MG7724**

## 5 KIT MAZA RUEDA DELANTERA

CHEVY:  
JOY  
MONZA  
POP  
SWING  
1994 - 2003

CHEVY PICK UP  
1999 - 2003



4 ROSCAS

**No. A.T.V. MG7724-K**

## 6 KIT REPUESTO MAZA RUEDA DELANTERA

CHEVY:  
JOY  
MONZA  
POP  
SWING  
1994 - 2003

CHEVY PICK UP  
1999 - 2003



4 BIRLOS

**No. A.T.V. MG7724-RP**

El uso de las marcas se hace exclusivamente con el propósito de indicar el modelo al que va destinada cada pieza.