

# insPurr<sup>Moduflex</sup>

## USER MANUAL

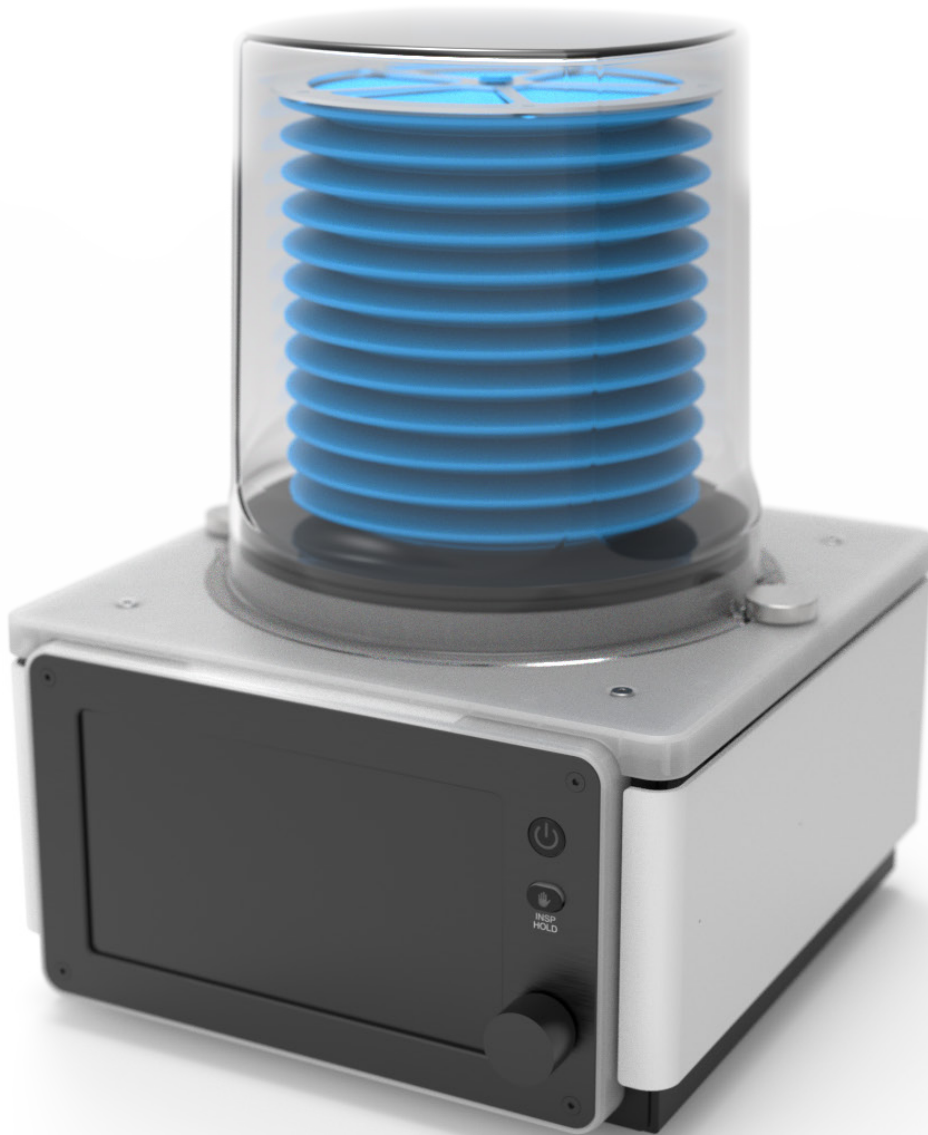

<b>Overview</b>	
1.1 Purpose of the Manual	4
1.2 Intended Audience	4
1.3 How to Use This Manual	4
<b>2. Safety Information</b>	
2.1 General Safety Guidelines	4
2.1.1 Personnel Qualifications	4
2.1.2 Device Location	4
2.1.3 Electrical Safety	4
2.1.4 Emergency Procedures	4
2.2 Warnings and Cautions	4
2.2.1 User Alert Symbols	4
2.2.2 Alarm Response	4
2.2.3 Preventing Contamination	4
2.3 Symbols Used in this Manual	5
<b>3. Product Description</b>	
3.1 Features	5
3.1.1 Intuitive User Interface	5
3.1.2 Versatile Ventilation Modes	5
3.1.3 Patient Monitoring Capabilities	5
3.1.4 Compact and Portable Design	5
3.1.5 Alarms and Safety Features	5
3.2 Technical Specifications	5
3.2.1 Ventilation Modes	5
3.2.2 Patient Range	5
3.2.3 Ventilation Parameters	5
3.2.4 Display	5
3.2.5 Power Requirements	5
3.2.6 Physical specifications and environmental	6
3.3 Components Included	6
<b>4.1 Unpacking and Inspection</b>	
4.1.1 Unpacking	6
4.1.2 Inspection	6
4.2 Setup and Installation	6
4.2.1 Location	6
4.2.2 Power Connection	6
4.2.3 Breathing System Hose Connection	6
<b>4.3 Powering On/Off</b>	
4.3.1 Powering On	7
4.3.2 Powering Off	7
<b>5. User Interface</b>	
5.1 Display Overview	7
5.1.1 Touchscreen Display	7
5.1.2 Display Layout	7
5.1.3 Status Indication Lights	7
5.2 Navigation Controls	7
5.2.1 Main Menu	7
5.2.2 Quick Controls	7
5.3 Menu Structure	7
5.3.1 Ventilation Modes	7
5.3.2 Settings	7
5.3.3 Monitoring	8
5.3.4 Alarms	8
5.3.5 Alarm Silence and Reset	8
<b>6. Operating Instructions</b>	
6.1 First Time Use	8
6.1.1 General Settings	8
6.1.2 Measurement units	8
6.1.3 Event Log	9
6.1.4 Time and Date	9

6.2 System Startup Settings .....	9	7.1.4 Bellows .....	15
6.3 Mode Selection .....	9	Inspect for Contaminants:	
6.3.1 Volume-Controlled Ventilation (VCV) .....	9	Pre-Cleaning:	
6.3.2 Pressure-Controlled Ventilation (PCV) .....	9	Cleaning Solution:	
6.4 Setting Ventilation Parameters .....	10	Cleaning Process:	
6.4.1 Preset Parameters .....	10	Rinse Thoroughly:	
Maximum Pressure:		Disinfection:	
Tidal Volume:		Drying:	
Respiratory Rate:		Reassembly:	
6.4.2 Adjustment for the Parameters .....	10	7.2 Regular Inspections .....	15
Parameters Live Adjustment:		7.2.1 Visual Inspection .....	16
Maximum Pressure		7.2.2 Functionality Check .....	16
Tidal Volume		7.2.3 Leak Test .....	16
6.4.3 Respiratory Rate .....	10	<b>8. Troubleshooting</b>	
6.4.4 Inspiratory/Expiratory Ratio (I:E) .....	10	8.1 Common Issues .....	17
6.4.5 Positive End Expiratory Pressure (PEEP) .....	10	My ventilator is not powering on.	
6.4.5 Inspiratory Hold .....	11	My Touchscreen is unresponsive.	
6.5 Monitoring Patient Parameters .....	11	8.3 Contact Information for Support .....	17
6.5.1 Real-Time Monitoring .....	11	Contact Information:	
6.5.2 Alarms .....	11	<b>9. Appendices</b>	
6.5.3 Alarm Management .....	14	9.1 Glossary of Terms .....	17
High Alarm:		9.2 Regulatory Compliance .....	17
Medium Alarm:		Regulatory Standards:	
6.5.5 Alarms Menu .....	14	Approval Bodies:	
6.6 Last Patient .....	14	Compliance Statement:	
<b>7. Maintenance and Care</b>		9.3 Warranty Information .....	17
7.1 Cleaning and Sterilization .....	14	Warranty Coverage:	
7.1.1 Daily Cleaning .....	14	<b>SERVICE AND INFORMATION CENTER</b>	
Power Off and Disconnect:		Contact us at:	
Wear Protective Gear:		Exclusions and Limitations:	
7.1.2 Breathing System Hose .....	15	Claims Process:	
7.1.3 Filters .....	15	9.4 Accessories .....	19

## Overview

Welcome to the InsPurr Veterinary Ventilator End User Manual. This comprehensive guide is designed to provide veterinarians, veterinary technicians, and clinic staff with the necessary information to operate and maintain the InsPurr Veterinary Ventilator effectively.

### 1.1 Purpose of the Manual

The primary purpose of this manual is to ensure users have a clear understanding of the InsPurr Veterinary Ventilator's features, functionality, and proper usage. It serves as a valuable resource for both novice and experienced users, offering step-by-step instructions, safety guidelines, and troubleshooting information.

### 1.2 Intended Audience

This manual is specifically crafted for veterinarians, veterinary technicians, and veterinary clinic owners and staff who are responsible for the operation and maintenance of the InsPurr Veterinary Ventilator. Whether you are a seasoned professional or new to veterinary ventilation technology, this manual aims to provide comprehensive guidance to enhance your experience with the device.

### 1.3 How to Use This Manual

To make the most of this manual, users are encouraged to follow the structured layout of the document. Begin with the "Introduction" for an overview of the manual's purpose and intended audience. Proceed through each section sequentially for a thorough understanding of the InsPurr Veterinary Ventilator, from setup and operation to maintenance and troubleshooting.

In case of any queries or issues, refer to the "Contact Information for Support" section for assistance. The glossary and index at the end of the manual offer quick reference points for terms and topics discussed throughout the document.

Thank you for choosing the InsPurr Veterinary Ventilator. We trust this manual will serve as a valuable companion in optimizing the performance of this advanced veterinary ventilation device.

## 2. Safety Information

Ensuring the safety of both patients and users is paramount when operating the InsPurr Veterinary Ventilator. Before using the device, it is crucial to thoroughly understand and adhere to the safety guidelines outlined in this section.

### 2.1 General Safety Guidelines

#### 2.1.1 Personnel Qualifications

Only trained and qualified veterinary professionals should operate the InsPurr Veterinary Ventilator. Ensure that users have a comprehensive understanding of respiratory support and ventilation principles.

#### 2.1.2 Device Location

The device is designed to maintain optimal performance and

safety across varying environmental conditions. It can operate seamlessly within an ambient room temperature range of 15°C to 35°C, ensuring reliable functionality in diverse clinical settings. Additionally, the ventilator can function effectively under atmospheric pressure conditions ranging from 75kPa to 106kPa. Placing the ventilator in a well-ventilated and easily accessible area is crucial to prevent overheating. Users should avoid obstructing air intakes and exhausts to facilitate proper airflow. It is important to shield the device from extreme temperatures, high humidity, and direct sunlight, ensuring the ventilator's sustained performance and longevity in varied healthcare environments.

#### 2.1.3 Electrical Safety

Use only the recommended power source and ensure it complies with the specified electrical requirements. Regularly inspect power cords for damage, and do not operate the device if the cord is compromised.

#### 2.1.4 Emergency Procedures

Familiarize yourself with emergency shutdown procedures. Always have a backup ventilation plan in case of device malfunction or power failure.

### 2.2 Warnings and Cautions

#### 2.2.1 User Alert Symbols

Pay close attention to symbols used in this manual and on the device. These symbols indicate important warnings or precautions that must be followed for safe operation.

#### 2.2.2 Alarm Response













Respond promptly to alarms. Familiarize yourself with alarm tones and meanings. In case of continuous alarms or unexpected device behavior, discontinue use and contact technical support.

#### 2.2.3 Preventing Contamination

Follow recommended cleaning and sterilization procedures to prevent cross-contamination between patients. Use only approved cleaning agents and follow the specified intervals for maintenance.

**2.3 Symbols Used in this Manual**

Refer to the provided symbol key to understand the meaning of symbols used throughout the manual. Symbols convey important information about warnings, precautions, and actions to be taken.

Symbol	Description	Symbol	Description
	Compliance to EU directives		WEEE marking, Compliance to EU directives
	Identify the manufacturer of the product.		Identify the manufacturer's catalogue number
	Identify the manufacturer's serial number		To indicate the manufactured date of the product
	To identify the location where the operator's manual is stored		To indicate that caution is necessary when operating the device
	to indicate how to lock and unlock for installation and removal of the bellows housing		MR Unsafe - do not use with magnetic resonance imaging (MRI)
	Conforms to ...		To identify any terminal which is intended for connection to an external conductor for protection against electric shock in case of a fault, or the terminal of a protective earth (ground) electrode.
	Power on/off switch		

**3. Product Description**

**3.1 Features**

The InsPurr Veterinary Ventilator is a state-of-the-art respiratory support device designed to meet the specific needs of veterinary professionals. Packed with advanced features, it offers:

**3.1.1 Intuitive User Interface**

The ventilator boasts an easy-to-navigate user interface, providing quick access to ventilation modes, parameters, and monitoring screens. The clear and concise display enhances user experience.

**3.1.2 Versatile Ventilation Modes**

Equipped with a range of ventilation modes, including controlled and assisted modes, the InsPurr Ventilator caters to various patient needs. It allows for precise pressure or volume controlled, respiratory rate, and other critical parameters.

**3.1.3 Patient Monitoring Capabilities**

The InsPurr device offers advanced patient monitoring capabilities, providing real-time oversight of crucial parameters throughout ventilation procedures. The incorporation of a sophisticated volume sensor enables the continuous monitoring of key metrics, including tidal volume, pressure and respiratory rate. This innovative feature ensures comprehensive and accurate data on inspired volumes and pressures, enhancing the precision and safety of the ventilation

process. The real-time feedback provided by the InsPurr device empowers veterinary professionals with the information needed to make informed decisions, contributing to optimal patient care and well-being during respiratory interventions.

**3.1.4 Compact and Portable Design**

The ventilator is designed with portability in mind, featuring a compact and lightweight construction. Its versatility makes it suitable for both clinical settings and transport situations.

**3.1.5 Alarms and Safety Features**

Built-in alarms alert users to deviations from set parameters, ensuring timely intervention. Safety features include backup power options and emergency shutdown protocols.

**3.2 Technical Specifications**

**3.2.1 Ventilation Modes**

- Controlled Ventilation (CV)
- Manual Ventilation (MV)

**3.2.2 Patient Range**

the patient weight range for the device is recommended to be from 1 kg to 100 kg. The rationale behind this specification is based on the maximum capacity of the bellows, which is 1.6L. Taking into account that the maximum volume per breath for a dog is typically 10-15 mL/kg, this translates to a maximum patient weight of approximately 100 kg. It is important to note that this figure is an approximation, as each patient is unique. Factors such as body conformation and overall health may vary, and this recommended weight range may not be universally applicable to all patients, both within and outside of this specified range. Users should exercise discretion and consider individual patient characteristics when using the InsPurr device.

**3.2.3 Ventilation Parameters**

- Tidal Volume
- Respiratory Rate
- Inspiratory/Expiratory Ratio
- Positive End-Expiratory Pressure (PEEP)

**3.2.4 Display**

High-resolution 7 inch color LCD with touchscreen display.

**3.2.5 Power Requirements**

Standard power supply with backup options for uninterrupted operation.

- Standard power supply with backup options for uninterrupted operation.
- Voltage 100-240VAC at 50-60 Hz
- Power 100 watts
- Fuse rating 1.5 amp fast blow

### 3.2.6 Physical specifications and environmental

Operating temperature 15 to 35 degrees celcius.  
Height. ? - Width ? - Depth ? - Weight ?

### 3.3 Components Included

The InsPurr Veterinary Ventilator comes complete with the following components:

- 940-0260-210, 22mm smooth bore tube
- 985-0065-000 evacuation tube
- 985-0070-000 y evacuation
- 985-3570772 30mm to 19mm evacuation raccord
- 945-0500-0026 tee airway pressure
- Breathing System Hose
- Power Cord
- User Manual
- Ventilator Unit
- Bellows

#### PHYSICAL VIEWS

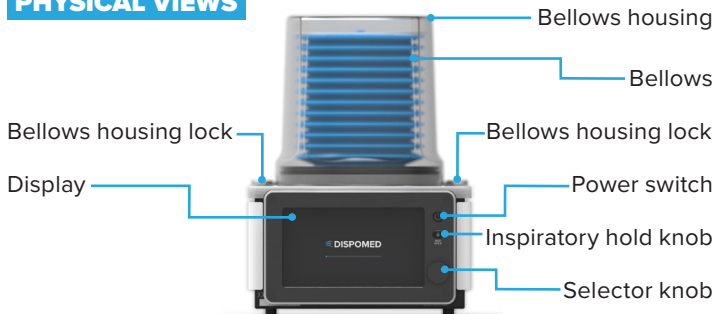

#### REAR VIEW

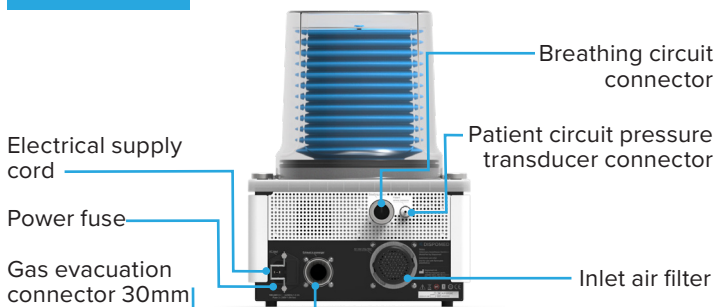

## 4.1 Unpacking and Inspection

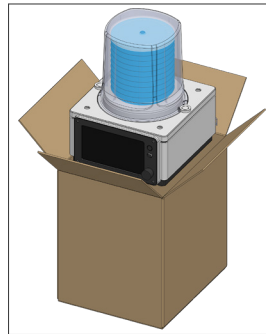

### 4.1.1 Unpacking

Carefully unpack the ventilator and associated components. Verify that all items listed in the user manual are present and undamaged.

### 4.1.2 Inspection

Thoroughly inspect the device for any visible damage during shipping. If damage is detected, contact the supplier immediately. Do not attempt to use a damaged device.

## 4.2 Setup and Installation

### 4.2.1 Location

Choose a well-ventilated and easily accessible location for the ventilator. Ensure there is sufficient space around the device for proper airflow and maintenance.

### 4.2.2 Power Connection

- Connect the ventilator to the power supply using the provided power cord. Confirm that the power source meets the specified electrical requirements of 100-240VAC at 50-60 Hz

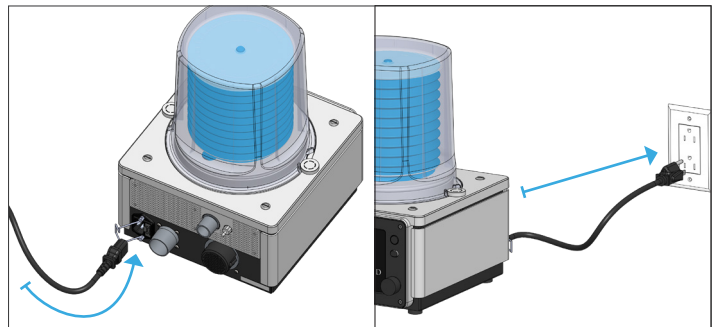

### 4.2.3 Breathing System Hose Connection

Assemble and connect the breathing system hose as per the instructions provided. Ensure a secure and airtight connection to guarantee effective ventilation.

## 4.3 Powering On/Off

### 4.3.1 Powering On



Press and hold the power button until the startup sequence initiates. Once the ventilator is ready for operation, the display will indicate readiness with a single beep and a white light (solid, not flashing).

### 4.3.2 Powering Off

To power off the ventilator press and hold the power button for 3 seconds by/or selecting the shutdown option from the menu.

Click the “Yes” button to power off the device. The device shutdown screen will appear.

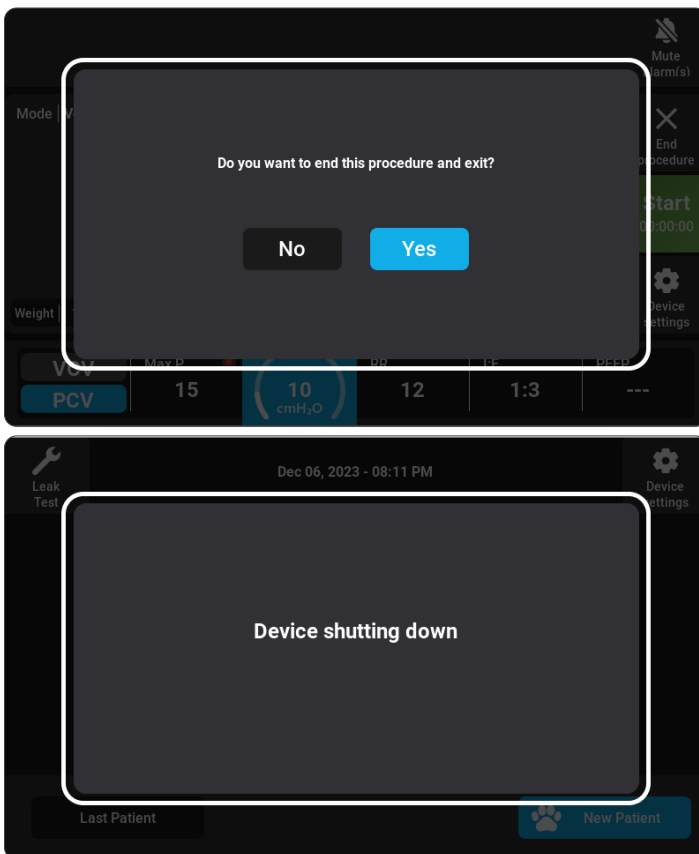

With these steps, you’ve successfully started the journey with the InsPurr Veterinary Ventilator. Proceed to the next sections of the manual for detailed information on the user interface, ventilation modes, and operational instructions. If you encounter any issues during setup, refer to the troubleshooting section or contact technical support for assistance.

## 5. User Interface

The user interface of the InsPurr Veterinary Ventilator is designed for ease of use, providing quick access to vital controls and

monitoring features. Familiarizing yourself with the interface will enhance your ability to operate the device efficiently.

## 5.1 Display Overview

### 5.1.1 Touchscreen Display

The 7” high-resolution (800 x 480) touchscreen display serves as the primary interaction point. It provides a clear view of ventilation parameters, patient monitoring data, and system status.

### 5.1.2 Display Layout

- **Main Screen:** Displays real-time patient information, including tidal volume, respiratory rate, and alarms.
- **Menu Bar:** Located at the top or bottom of the screen, the menu bar provides access to different functions and settings.
- **Navigation Controls:** Use the touchscreen to navigate through menus, adjust settings, and select options.

### 5.1.3 Status Indication Lights

The device incorporates clear operating status indication lights on its front panel to provide users with immediate visual feedback.

- **Blue light (solid, not flashing):** Indicates ongoing ventilation with no alarms.
- **White light (solid, not flashing):** Represents non-operational state or alert, signaling issues or inactivity.

## 5.2 Navigation Controls

### 5.2.1 Main Menu

Access the main menu by tapping the menu icon. From here, you can navigate to various sections, including ventilation modes, settings, and alarms.

### 5.2.2 Quick Controls

Commonly used controls, such as adjusting tidal volume or respiratory rate, may have dedicated on-screen buttons for quick adjustments.

## 5.3 Menu Structure

### 5.3.1 Ventilation Modes

Navigate to the ventilation modes section to select the appropriate mode for your patient. Options include Controlled Ventilation (CV) and Manual Ventilation (MV).

### 5.3.2 Settings

Access the settings menu to configure parameters such as tidal volume, respiratory rate, and alarms. Ensure settings align with the specific requirements of your patient.

### 5.3.3 Monitoring

View real-time patient data, including graphical representations of tidal volume and respiratory rate. Monitoring screens provide valuable insights into the effectiveness of ventilation.

### 5.3.4 Alarms

Review and configure alarm settings. Acknowledge and troubleshoot alarms promptly to ensure patient safety.

### 5.3.5 Alarm Silence and Reset

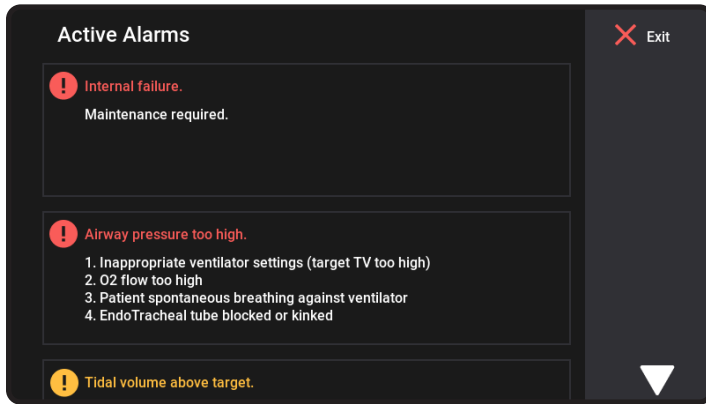

In the event of alarms, quickly silence audible by pressing the alarm button. The silent mode will persist for a duration of 2 minutes, after which, if the alarm still persists, it will resume beeping. Alternatively, reset the system from the main screen. Always promptly investigate and address the cause of alarms.

Familiarize yourself with the user interface by exploring each section of the menu. Practice navigating through different screens to build confidence in using the InsPurr Veterinary Ventilator effectively. Detailed operational instructions for each menu option can be found in subsequent sections of this manual.

## 6. Operating Instructions

Operating the InsPurr Veterinary Ventilator involves a series of steps to set up, control ventilation parameters, and monitor the patient. Follow the guidelines below for a comprehensive understanding of the operating procedures.

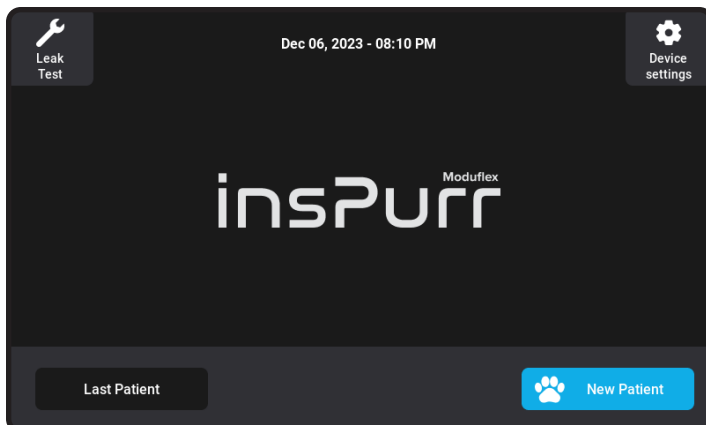

## 6.1 First Time Use

Select the Device Setting Button

### 6.1.1 General Settings

- Select your preferred language between French and English
- Modify your maximum inspiratory hold duration as necessary. The default setting for the maximum inspiratory hold duration is 10 seconds, with a selectable range between 5 to 30 seconds.

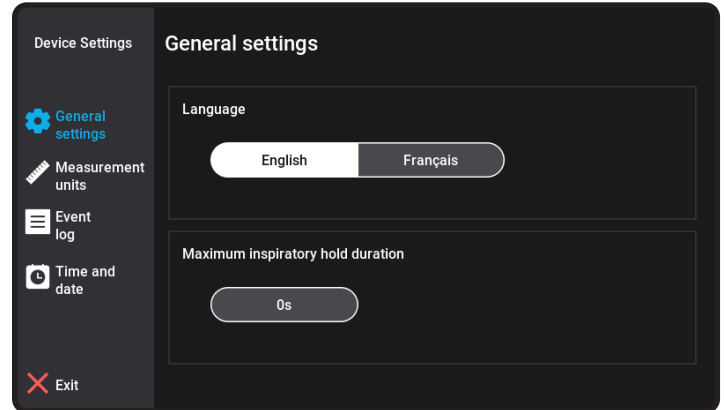

### 6.1.2 Measurement units

Select your pressure units, volume units and weight units value preference.

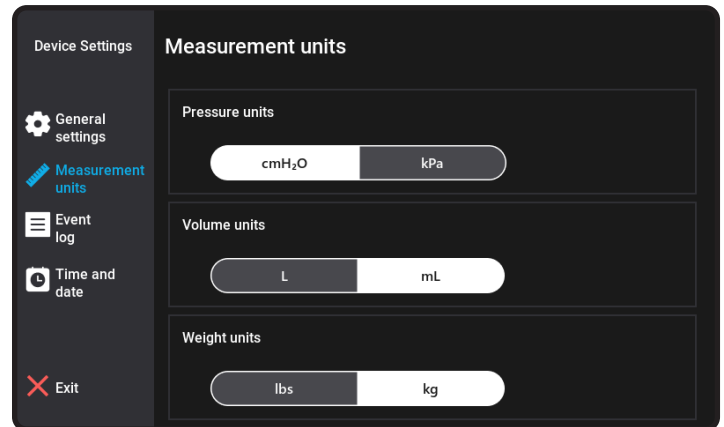



### 6.1.3 Event Log

Previous alarm will be displayed in this menu.

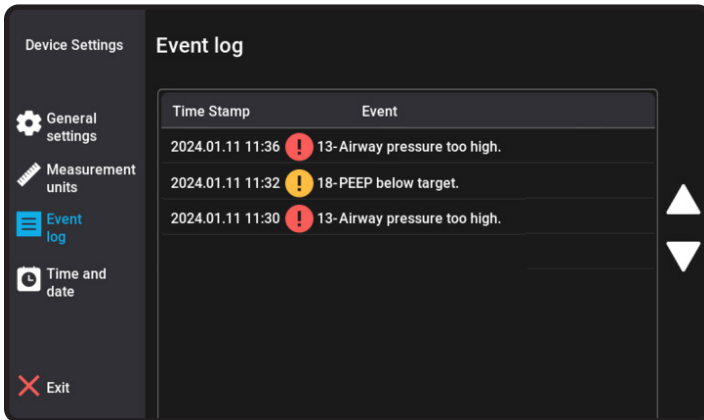

### 6.1.4 Time and Date

Program the time and date.

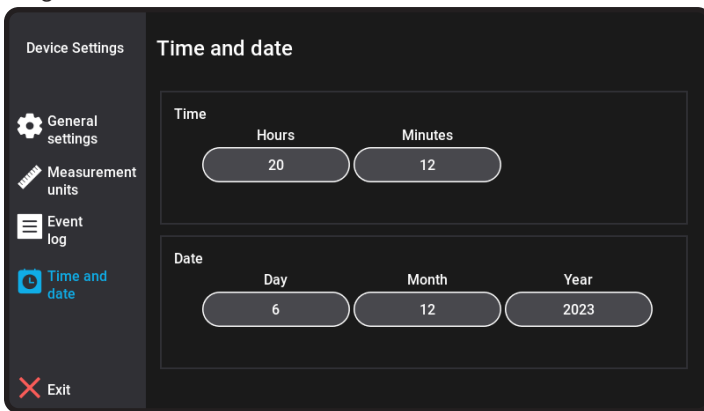

Press the "Exit" button to return to the main menu.

### 6.2 System Startup Settings

- Select the New Patient button or Last Patient (if this is not the first time using the insPurr ventilator).
- Set the patient's weight



### 6.3 Mode Selection

Choose the desired ventilation mode.

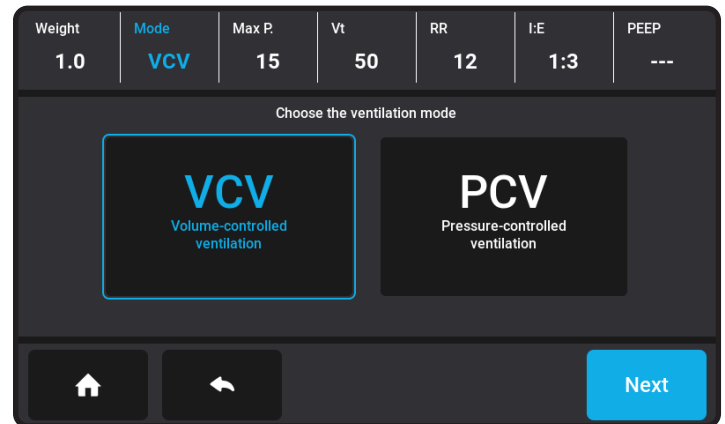

#### 6.3.1 Volume-Controlled Ventilation (VCV)

Select "Volume-Controlled Ventilation (VCV)."

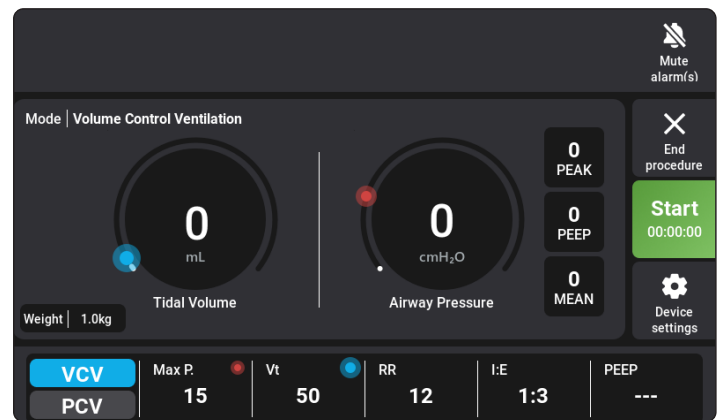

OR

#### 6.3.2 Pressure-Controlled Ventilation (PCV)

- Select "Pressure-Controlled Ventilation (PCV)."
- Press next

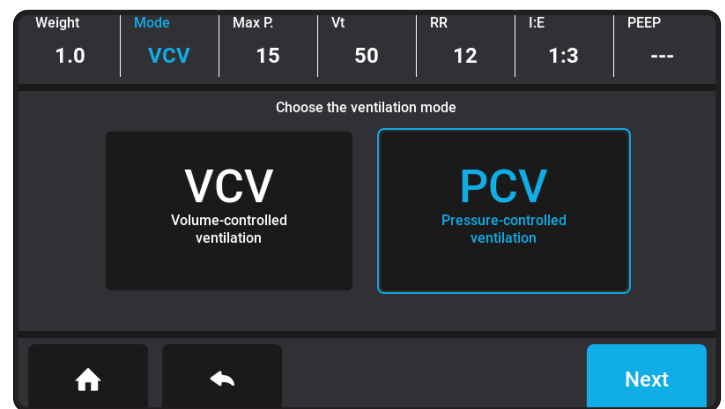

## 6.4 Setting Ventilation Parameters

### 6.4.1 Preset Parameters

#### Maximum Pressure:

The maximum pressure setting on the device is consistently maintained at 10 cmH<sub>2</sub>O, regardless of the patient's weight. This standardized maximum pressure ensures a uniform and reliable threshold for respiratory support, offering simplicity and ease of use for veterinary professionals.

#### Tidal Volume:

The parameter settings for volume on the device are established using a straightforward and clinically relevant formula: volume (mL) = weight (kg) \* 10 (mL/kg). This formula considers the patient's weight as a fundamental factor in determining the appropriate volume for ventilation. By multiplying the weight in kilograms by the standard volume-per-kilogram value of 10 mL, the device ensures that the set volume aligns with the individualized needs of the patient. This approach not only simplifies the calibration process but also promotes precision in delivering tailored respiratory support.

#### Respiratory Rate:

The ventilator ensures user convenience by displaying default respiratory rate values based on the patient's weight. For patients weighing less than 10 kg (22 lb), the default respiratory rate is set at 12 breaths per minute (bpm). In the weight range of 10 kg (22 lb) to 30 kg (66 lb), the default respiratory rate is 10 bpm. For patients exceeding 30 kg (66 lb) in weight, the default respiratory rate is set to 8 bpm.

Weight	Max P	Vt	RR	I:E
1 kg to 10 kg (22lb)	10 cmH <sub>2</sub> O	volume (mL) = weight (kg) * 10 (mL/kg)	12 bpm	1:3
between 10kg (22lb) and 30kg (66lb)	10 cmH <sub>2</sub> O	volume (mL) = weight (kg) * 10 (mL/kg)	10 bpm	1:3
Between 30kg (66lb) and 100kg (220lb)	10 cmH <sub>2</sub> O	volume (mL) = weight (kg) * 10 (mL/kg)	8 bpm	1:3

### 6.4.2 Adjustment for the Parameters

#### Parameters Live Adjustment:

The device maintains uninterrupted ventilation even during parameter adjustments. It waits for user confirmation before applying the new setting at the next breathing cycle, ensuring a controlled and seamless transition without compromising respiratory support. This feature allows quick parameter fine-tuning without disruption to ongoing ventilation procedures.

#### Maximum Pressure

- Select the Maximum Pressure (Max P) button menu and adjust as needed.
- Confirm the chosen maximum pressure before initiating ventilation. The adjustable range spans is from 7 to 60 cmH<sub>2</sub>O with a increment of 1cmH<sub>2</sub>O, providing a comprehensive

spectrum to accommodate diverse clinical scenarios. The device airway pressure measurement accuracy is of +/- 15%.

- To enhance user convenience and flexibility, the adjustment of the maximum pressure on the Inspurr device can be seamlessly achieved through a combination of the touchscreen and the rotary knob.

#### Tidal Volume

- Select the Tidal Volume (VT) button menu and adjust as needed.
- Confirm the chosen tidal volume before initiating ventilation. The adjustable tidal volume range is from 50 mL to 1500 mL, with increments as fine as 1 mL, allowing veterinary professionals to fine-tune ventilation parameters with a high level of precision. The device's volume delivery accuracy is meticulously maintained relative to the tidal volume setting. For volumes greater than 100 mL, the accuracy is better than or equal to ±20%, while for volumes less than or equal to 100 mL, the accuracy remains within ±50%. This measured volume accuracy ensures reliable and consistent performance, enhancing the overall efficacy and safety of the Inspurr device in delivering optimal tidal volumes during ventilation.
- To enhance user convenience and flexibility, the adjustment of the tidal volume on the Inspurr device can be seamlessly achieved through a combination of the touchscreen and the rotary knob.

### 6.4.3 Respiratory Rate

- Select the respiratory rate (RR) button menu and adjust as needed.
- Confirm the chosen respiratory rate before initiating ventilation. The device allows users to set the respiratory rate within a range of 2 to 30 breaths per minute, offering fine adjustments with increments of 1 breath per minute. This level of granularity allows veterinary professionals to tailor ventilation parameters to the specific requirements of each patient. The Inspurr device boasts an accuracy of +/- 10%, ensuring that the delivered respiratory rate aligns closely with the user-defined settings.
- To enhance user convenience and flexibility, the adjustment of respiratory rate on the Inspurr device can be seamlessly achieved through a combination of the touchscreen and the rotary knob.

### 6.4.4 Inspiratory/Expiratory Ratio (I:E)

- Select the Inspiratory/Expiratory Ratio (I:E) button menu and adjust as needed.
- Confirm the selected Inspiratory/Expiratory Ratio (I:E) before initiating ventilation. The adjustment can be made using the following values: 1:1, 1:2, 1:3, 1:4, or 1:5. The device maintains an I:E ratio accuracy that is better than or equal to ±10% relative to the set I:E ratio.
- To enhance user convenience and flexibility, the adjustment of the Inspiratory/Expiratory Ratio (I:E) on the Inspurr device can be seamlessly achieved through a combination of the touchscreen and the rotary knob.

### 6.4.5 Positive End Expiratory Pressure (PEEP)

- Select the Positive End Expiratory Pressure (PEEP) button menu and adjust as needed.

- Confirm the selected Positive End Expiratory Pressure (PEEP) before initiating ventilation. The device allows the user to either disable PEEP (off) or activate it within a range of 2 to 10 cmH<sub>2</sub>O, with adjustments available in increments of 1 cmH<sub>2</sub>O. It is important to note that the PEEP level cannot be set higher than the maximum working pressure.
- To enhance user convenience and flexibility, the adjustment of the Positive End Expiratory Pressure (PEEP) on the Inspurr device can be seamlessly achieved through a combination of the touchscreen and the rotary knob.

### 6.4.5 Inspiratory Hold

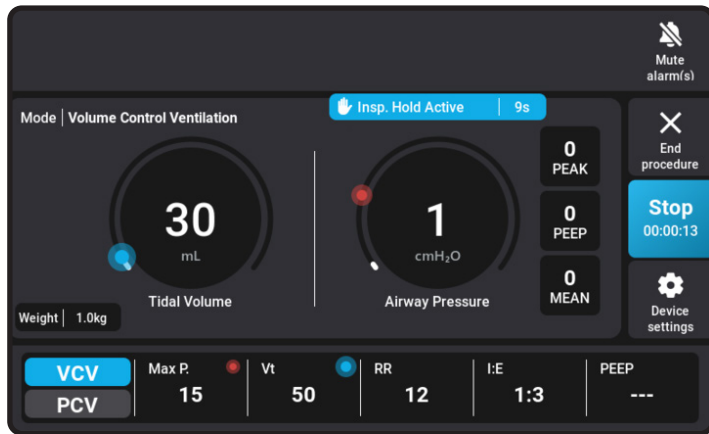

- Press the inspiratory hold button to initiate the inspiratory hold, during which the breathing cycle is paused at the end of the current or next inspiration for as long as the button is pressed (no expiration allowed). A blue message will display the elapsed time of the inspiratory hold once activated.
- The inspiratory hold ceases either when the set maximum duration is achieved or upon releasing the button, at which point the breathing cycle resumes. Throughout the inspiratory hold, any apnea or sustained airway pressure alarms triggered by the hold are audio or alarm paused for the inspiratory-hold duration.
- The maximum inspiratory-hold time for a non-adjustable inspiratory hold is 10s, while a configurable or adjustable inspiratory hold can range from 5 to 30 seconds, with increments of 1s (default value is 10 seconds), set via the touchscreen and rotary knob.
- The ventilator automatically resumes the breathing cycle when the inspiratory hold reaches the maximum allowed duration, even if the inspiratory hold button is still pressed.

## 6.5 Monitoring Patient Parameters

### 6.5.1 Real-Time Monitoring

Review real-time patient data, including tidal volume and respiratory rate through the general screen.

Ensure that monitored parameters fall within acceptable ranges.

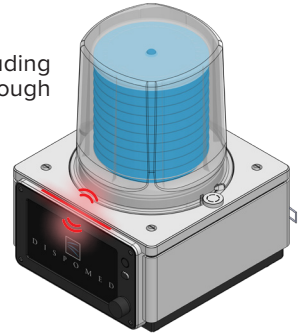

### 6.5.2 Alarms

Whenever there is a parameter that is too low or too high you will be notified by a visual and audible alarm. A message will also be displayed on the top of the screen.

The visual alarm will be both noticeable by the led light changing from green to red and the associated parameter changing from blue to red.

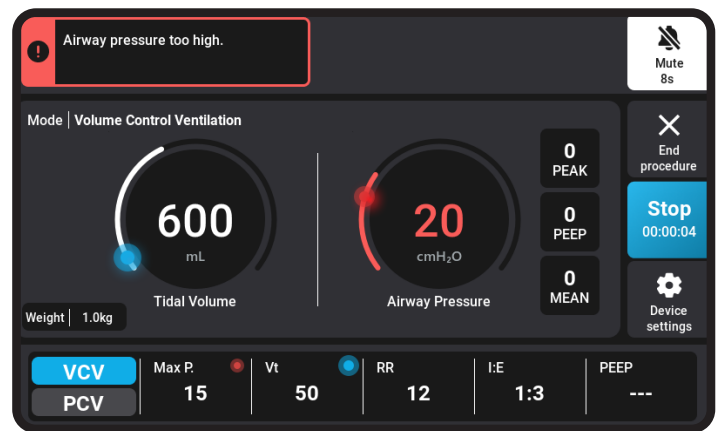

DESCRIPTION	TYPE	MODE	PRIORITY	MESSAGE DISPLAYED	TRIGGER
Patient airway pressure above safety limit	Physiological	VCV & PCV	HIGH	Airway pressure too high	As soon as the airway pressure exceeds the user maximum pressure setting.
Patient airway pressure too high (but below safety limit) during expiration	Physiological	VCV & PCV	HIGH	High airway pressure during expiration	After 33% of expiration time, airway pressure has not decreased by more than 60% of the difference between the pressure value at the beginning of expiration and the PEEP target. (applies only if pressure at the beginning of expiration is > 6cmH <sub>2</sub> O)
Negative patient airway pressure	Physiological	VCV & PCV	HIGH	Negative airway pressure	Airway pressure falls -5cmH <sub>2</sub> O below atmospheric pressure for more than 500ms.
Patient airway pressure too low during inspiration	Physiological	VCV & PCV	MEDIUM	Low airway pressure during inspiration	Pressure below 6cmH <sub>2</sub> O after 90% of inspiration time.
Measured volume above tidal volume setting	Physiological	VCV only	MEDIUM	Tidal volume above target	Measured volume above tidal volume setting (+20%) for 2 consecutive respiratory cycles, excluding the first 5 cycles of ventilation (new parameters or live parameter adjustment).
Measured PIP above PIP target	Physiological	PCV only	MEDIUM	PIP above target	Measured PIP above PIP setting (+10%) for 2 consecutive respiratory cycles, excluding the first 5 cycles of ventilation (new parameters or live parameter adjustment).
Measured PEEP above PEEP target	Physiological	VCV & PCV	MEDIUM	PEEP above target	Measured PEEP above PEEP setting (+20%) for 5 consecutive respiratory cycles, excluding the first 5 cycles of ventilation (new parameters or live parameter adjustment).
Measured volume below tidal volume setting	Physiological	VCV only	MEDIUM	Tidal volume below target	Measured volume below tidal volume setting (-20%) for 2 consecutive respiratory cycles, excluding the first 5 cycles of ventilation (new parameters or live parameter adjustment)
Measured PIP below PIP target	Physiological	PCV only	MEDIUM	PIP below target	Measured PIP below PIP setting (-10%) for 2 consecutive respiratory cycles, excluding the first 5 cycles of ventilation (new parameters or live parameter adjustment).
Measured PEEP below PEEP target	Physiological	VCV & PCV	MEDIUM	PEEP below target	Measured PEEP below PEEP setting (-20%) for 5 consecutive respiratory cycles, excluding the first 5 cycles of ventilation (new parameters or live parameter adjustment).
Internal component failure	Technical	Self-test Standby VCV & PCV	HIGH / MEDIUM / LOW?	Internal failure - Maintenance required	<ul style="list-style-type: none"> <li>power supply voltage failure (24V &amp; 5V)</li> <li>fan rotation failure</li> <li>touchscreen failure (I2C not responding)</li> <li>flow sensor failure (I2C not responding)</li> <li>pressure sensors failure (below 0.5V or above)</li> <li>turbine failure (driver fault or overheating)</li> <li>data storage (memory) failure??</li> <li>date and time??</li> <li>software integrity?? (checksum)</li> <li>firmware vs hardware mismatch??</li> <li>autres??</li> </ul>

			VENTILATOR ALARMS MESSAGES
TERMINATION	MAX MUTE TIME	ACTION BY THE DEVICE	DETAILED MESSAGE DISPLAYED
When airway pressure goes below the user maximum pressure setting.	<b>0s</b> (mute not allowed)	Stop inspiration, perform a full expiration, then perform a new inspiration only when the alarm is deactivated.	<ol style="list-style-type: none"> <li>1. Inappropriate ventilator settings (target TV too high)</li> <li>2. O2 flow too high</li> <li>3. Patient spontaneous breathing against ventilator</li> <li>4. EndoTracheal tube blocked or kinked</li> <li>5. Respiratory circuit or ventilator tube blocked or kinked</li> <li>6. Decreased compliance (pressure on chest wall, pneumothorax, etc.)</li> <li>7. Obstruction of ventilator exhaust</li> <li>8. If none of the above applies, switch to manual ventilation immediately</li> </ol>
When airway pressure goes below the PEEP target or below 3cmH2O if PEEP is off	<b>0s</b> (mute not allowed)	Do not perform inspiration as long as the alarm is active. Once the alarm is deactivated, wait during a full expiration time then perform a new inspiration.	<ol style="list-style-type: none"> <li>1. Patient spontaneous breathing against ventilator</li> <li>2. O2 flow too high</li> <li>3. Obstruction of ventilator exhaust</li> <li>4. External pressure on patient thorax</li> </ol>
When airway pressure goes above -5cmH2O for 500ms.	<b>0s</b> (mute not allowed)	NONE (continue ventilation)	<ol style="list-style-type: none"> <li>1. Patient spontaneous breathing against ventilator</li> </ol>
When airway pressure goes above 6cmH2O during inspiration.	<b>120s</b>	NONE (continue ventilation)	<ol style="list-style-type: none"> <li>1. Inappropriate ventilator settings (target TV too low)</li> <li>2. Patient spontaneous breathing with ventilator</li> <li>3. Leak or disconnection in the ET tube, anesthesia circuit or ventilator</li> <li>4. Bellows not properly filled at the start of inspiration</li> <li>5. Airway pressure measurement tubing not connected</li> </ol>
When volume is on target ( $\pm 20\%$ ) for 2 consecutive cycles.	<b>120s</b>	NONE / RÉ-APPRENDRE?	<ol style="list-style-type: none"> <li>1. Patient spontaneous breathing with ventilator</li> <li>2. Sudden change of compliance (pressure on chest or lungs, etc)</li> </ol>
When PIP is on target ( $\pm 10\%$ ) for 2 consecutive cycles.	<b>120s</b>	NONE / RÉ-APPRENDRE?	<ol style="list-style-type: none"> <li>1. O2 flow too high</li> <li>2. Patient spontaneous breathing against ventilator</li> <li>3. EndoTracheal tube blocked or kinked</li> <li>4. Respiratory circuit or ventilator tube blocked or kinked</li> <li>5. Decreased compliance (pressure on chest wall, pneumothorax, etc.)</li> </ol>
When PEEP is on target ( $\pm 20\%$ ) for 5 consecutive cycles.	<b>120s</b>	NONE / RÉ-APPRENDRE?	<ol style="list-style-type: none"> <li>1. Patient spontaneous breathing against ventilator</li> <li>2. O2 flow too high</li> <li>3. External pressure on patient thorax</li> <li>4. Obstruction of ventilator exhaust</li> <li>5. If none of the above applies, decrease PEEP target or turn PEEP off</li> </ol>
When volume is on target ( $\pm 20\%$ ) for 2 consecutive cycles.	<b>120s</b>	NONE / RÉ-APPRENDRE?	<ol style="list-style-type: none"> <li>1. Maximum airway pressure limit reached</li> <li>2. Sudden change of compliance (pressure on chest or lungs, etc)</li> <li>3. Inappropriate ventilator settings (target TV too high or inspiratory time too short)</li> </ol>
When PIP is on target ( $\pm 10\%$ ) for 2 consecutive cycles.	<b>120s</b>	NONE / RÉ-APPRENDRE?	<ol style="list-style-type: none"> <li>1. Patient spontaneous breathing with ventilator</li> <li>2. Leak or disconnection in the ET tube, anesthesia circuit or ventilator</li> <li>3. Bellows not properly filled at the start of inspiration</li> <li>4. Sudden change of compliance (pressure on chest or lungs, etc)</li> <li>5. Airway pressure measurement tubing not connected</li> </ol>
When PEEP is on target ( $\pm 20\%$ ) for 5 consecutive cycles.	<b>120s</b>	NONE / RÉ-APPRENDRE?	<ol style="list-style-type: none"> <li>1. Patient spontaneously inspiring during expiratory cycle</li> <li>2. Leak or disconnection in the ET tube, anesthesia circuit or ventilator</li> <li>3. Bellows empty or not filled enough</li> <li>4. Airway pressure measurement tubing not connected</li> </ol>
When fault is resolved		<p>- dépend de la panne</p> <p>- pour la fan, on ne stoppe pas la ventilation en cours, mais on empêche d'en partir une nouvelle</p>	Internal failure - Maintenance required (error code xxx)

### 6.5.3 Alarm Management

- To temporarily silence the alarm, press the mute button. The alarm will be muted for a duration of X, after which it will resume beeping if the issue persists. The visual alarm will continue to be active.
- The ventilator displays an indication that the auditory alarm signals are muted, and the remaining mute time (countdown from the maximum duration) is shown on the screen.
- The maximum duration for muting auditory alarms is 120 seconds, after which the auditory alarm signals will automatically resume. If a new alarm occurs during the mute period, the auditory signals will be automatically unmuted.

#### High Alarm:

A high alarm on the ventilator signifies a critical condition that requires immediate attention and intervention. This alarm level is activated when there is a significant deviation or a potentially life-threatening situation. Examples of conditions that may trigger a high alarm include an abrupt change in airway pressure, or a disconnection in the ventilation circuit. The visual and auditory signals associated with a high alarm are typically distinctive and urgent, aiming to alert healthcare providers promptly. In response to a high alarm, healthcare professionals are expected to take immediate action to address the underlying issue, potentially involving adjustments to ventilation settings, airway management, or other emergency interventions to ensure patient safety and well-being. The specific parameters and triggers for high alarms can vary based on the ventilator's design and the criticality of the patient's condition.

#### Medium Alarm:

A medium alarm on the ventilator typically indicates a condition that requires attention but may not be an immediate threat to the patient's well-being. This type of alarm is designed to alert healthcare providers to a moderate level of concern, prompting them to assess the situation and make necessary adjustments. Examples of conditions triggering a medium alarm could include variations in respiratory parameters or other moderate deviations from the preset ventilation settings. The visual and auditory cues associated with a medium alarm are usually distinct, allowing healthcare professionals to identify and address the issue promptly while maintaining an appropriate level of urgency in patient care. The specific parameters and triggers for medium alarms can vary depending on the ventilator's design and the patient's condition.

### 6.5.5 Alarms Menu

Access the alarms menu to review active alarms.

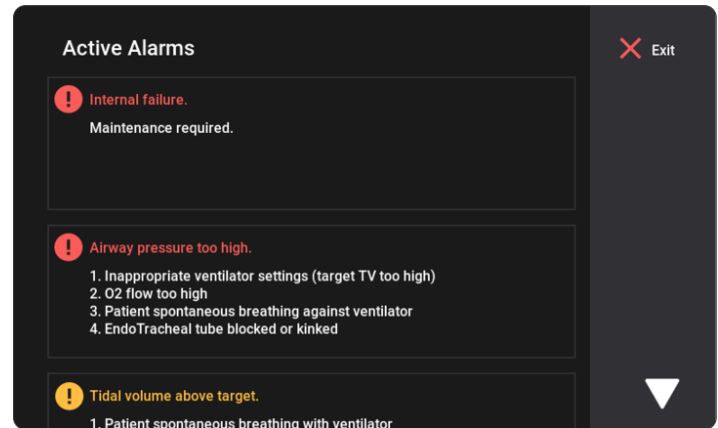

For each alarm, you will receive some possible solutions on how to solve the alarm.

In case multiple alarms are raised simultaneously, the ventilator will indicate that multiple alarms are active and display them in order of priority. In case multiple alarms have the same priority, the ventilator will display them in their order of occurrence.

### 6.6 Last Patient



You can access your last patient's parameters by pressing the last patient button located at the bottom left of the ventilator screen. This feature is particularly useful in case of a momentary power outage. Instead of re-entering your last parameters, you can simply select the last patient to regain access to their information.

## 7. Maintenance and Care

Proper maintenance and care are essential to ensure the longevity and reliability of the InsPurr Veterinary Ventilator. Follow the guidelines below to keep the device in optimal working condition.

### 7.1 Cleaning and Sterilization

#### 7.1.1 Daily Cleaning

## Power Off and Disconnect:

- Ensure the veterinary ventilator is powered off.
- Disconnect the ventilator from the power source.

## Wear Protective Gear:

- Put on appropriate personal protective equipment, such as gloves and a mask, to protect yourself from potential contaminants.
- Wipe down the exterior surfaces with a mild, non-abrasive disinfectant.
- Clean the touchscreen display with a soft, lint-free cloth.
- Ensure all ports and connectors are free from debris.

## 7.1.2 Breathing System Hose

- Disconnect the breathing system from the anesthesia machine and the ventilator.
- Follow manufacturer guidelines for cleaning or replacing disposable components.
- Sterilize reusable components using an approved method.

## 7.1.3 Filters

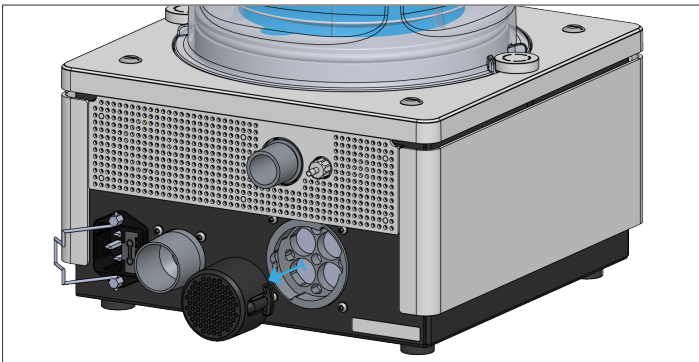

- Monthly inspect the air intake filter. Replace the filter if necessary.
- Clean or replace filters more frequently if operating in a dusty environment.

## 7.1.4 Bellows

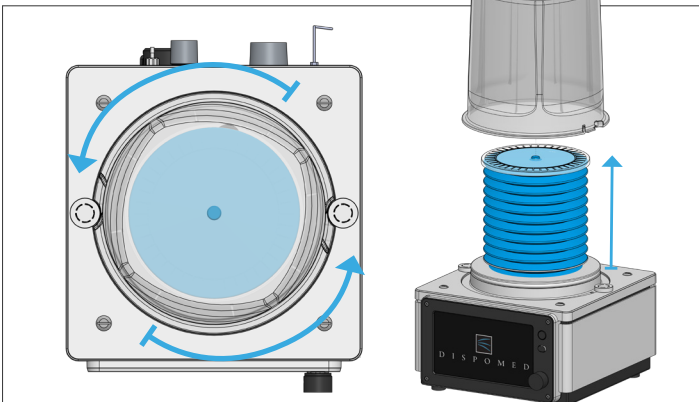

Remove the bellows housing and then carefully remove the silicone bellows from the ventilator.

## Inspect for Contaminants:

Inspect the bellows for any visible contaminants or signs of wear.

## Pre-Cleaning:

If there are visible contaminants, gently wipe the surface with a damp cloth or sponge to remove loose dirt and debris.

## Cleaning Solution:

Prepare a cleaning solution typically, a mild, non-abrasive, and veterinary-approved disinfectant should be used.

## Cleaning Process:

- Immerse the silicone bellows in the cleaning solution.
- Use a cloth to gently scrub the surface, paying attention to seams and folds where contaminants may accumulate.

## Rinse Thoroughly:

Rinse the bellows thoroughly with clean water to remove any residue from the cleaning solution.

## Disinfection:

Follow the manufacturer's guidelines for disinfecting the silicone bellows. This may involve soaking it in a veterinary-approved disinfectant for a specified duration.

## Drying:

Allow the silicone bellows to air-dry completely before reattaching it to the ventilator. Ensure it is thoroughly dried to prevent the growth of mold or bacteria.

## Reassembly:

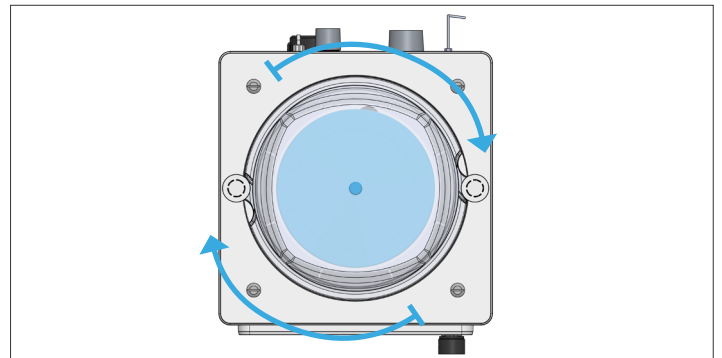

Reassemble the bellows and the bellows housing on the ventilator.

## 7.2 Regular Inspections

### 7.2.1 Visual Inspection

- Conduct a visual inspection of cables, hoses, and connectors for signs of wear.
- Check for any loose or damaged parts.
- Ensure labels and markings are legible.

### 7.2.2 Functionality Check

- Power on the ventilator and perform a quick functionality check.
- Verify that the touchscreen, controls, and alarms are responsive.
- Confirm proper operation of ventilation modes.

### 7.2.3 Leak Test

Users must perform a leak test of the ventilator and the anesthesia machine before each use to ensure optimal functionality and patient safety. Follow the seven steps to be ready for ventilator testing.

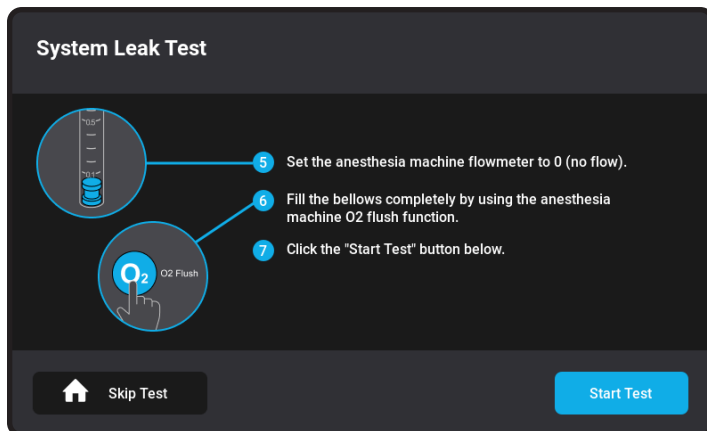
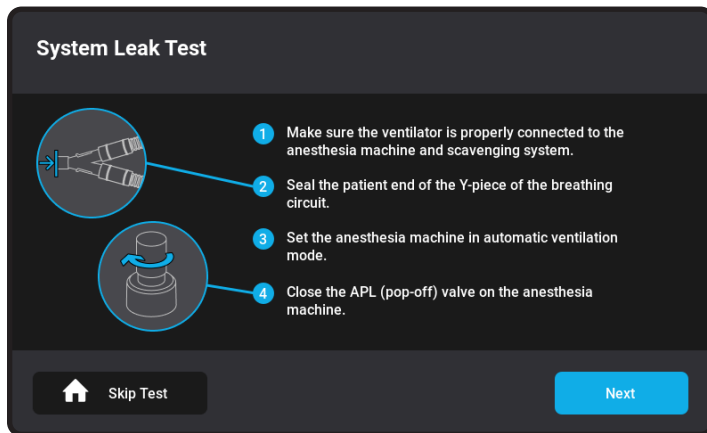

Once these steps are completed, press “Start Test,” and the leak test will automatically begin.

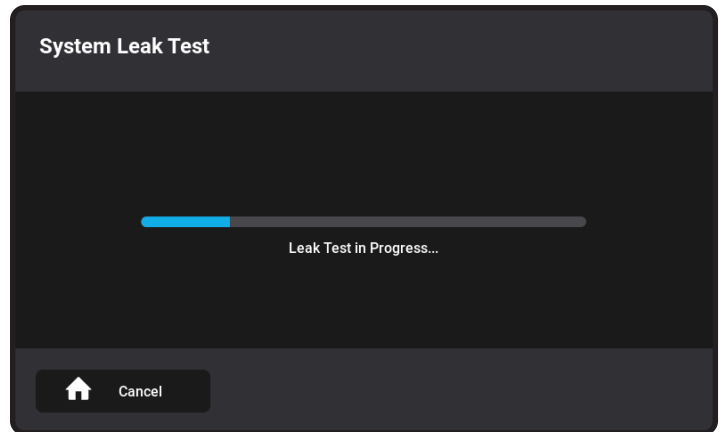

If the leak test passed, the ventilator is ready to use.

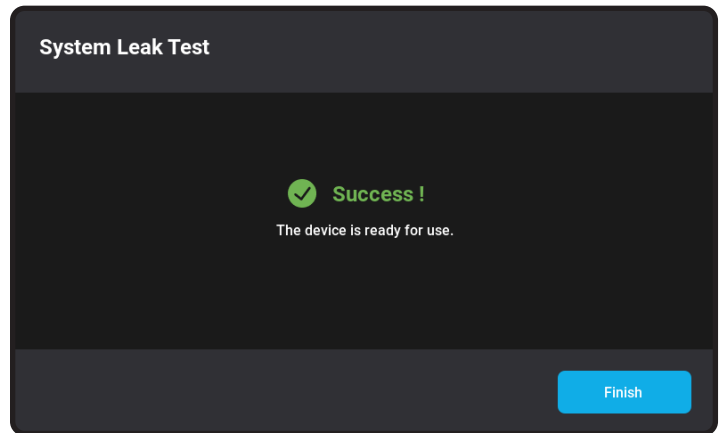

Leak test failed.

If the leak test failed, follow the four different steps written on the leak test screen. If the test fails again, refer to the troubleshooting section of the manual.

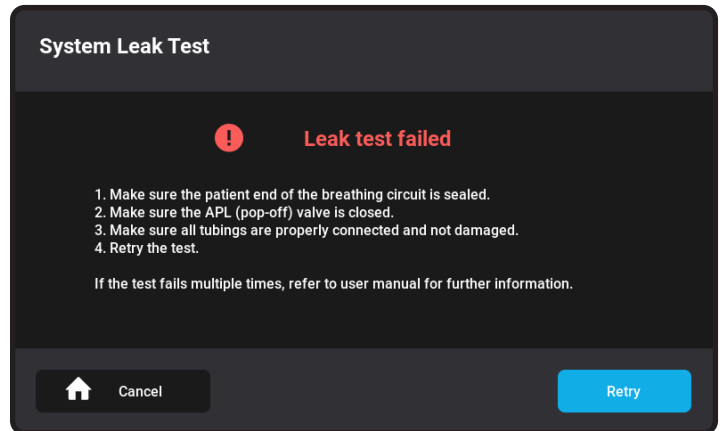



## 8. Troubleshooting

In the event of unexpected issues or alarms, the following troubleshooting guide for the InsPurr Veterinary Ventilator can help identify and resolve problems promptly. If you encounter persistent issues, contact technical support for further assistance.

### 8.1 Common Issues

If I have followed the alarm recommendations and the alarm persists, what should I do?

- Review alarm messages on the display.
- Address the underlying cause, such as incorrect settings or patient issues.
- Silence alarms only after addressing the cause.

#### My ventilator is not powering on.

- Check power connections and ensure the power source is functional.
- Confirm the power button is pressed and held for the required duration.
- Verify power cord integrity and replace if damaged.
- Verify the fuse at the power inlet.

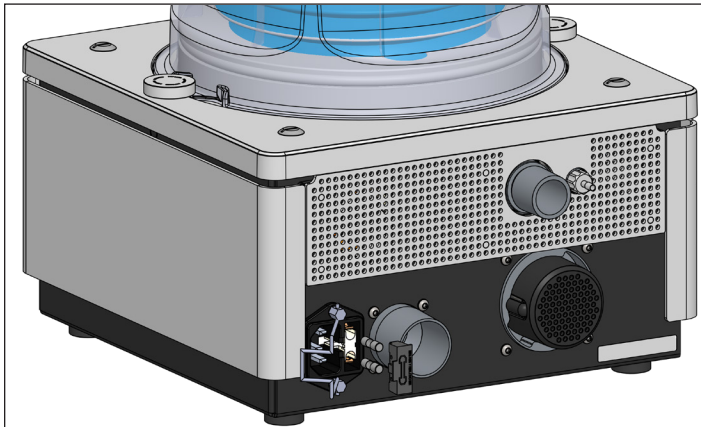

#### My Touchscreen is unresponsive.

- Clean the touchscreen with a soft, lint-free cloth.
- Ensure the screen is not damaged.
- Restart the ventilator and check for responsiveness.

### 8.3 Contact Information for Support

If troubleshooting does not resolve the issue, promptly contact technical support for assistance. Provide detailed information about the problem, any error messages, and the steps you've taken to troubleshoot. Technical support can guide you through additional diagnostics or arrange for service if required.

#### Contact Information:

Customer Support Hotline: 1 450 759-9395 or 1-800-363-1746

Email Support: [info@dispomed.com](mailto:info@dispomed.com)

Online Support Portal: [www.dispomed.com](http://www.dispomed.com) or insPurr QR code.

Remember to provide your device's serial number and any relevant details about your setup when contacting support for a more efficient resolution.

## 9. Appendices

### 9.1 Glossary of Terms

This glossary provides definitions for key terms used throughout the InsPurr Veterinary Ventilator manual. Refer to this section for clarification on technical terminology.

<b>PEEP</b>	Positive end Expiratory Pressure	The pressure in the airways at the end of expiration to prevent alveolar collapse.
<b>VT</b>	Tidal Volume	The volume of air moved into or out of the lungs during one breath
<b>RR</b>	Respiratory Rate	The number of breaths taken by a patient in one minute.
<b>Ventilation Modes</b>		
<b>VCV</b>	Volume-Controlled Ventilation	Ventilator is controlled by the volume and limited by the pressure.
<b>PCV</b>	Pressure-Controlled Ventilation	Ventilator is controlled by the pressure.

### 9.2 Regulatory Compliance

The InsPurr Veterinary Ventilator complies with relevant regulatory standards and certifications. This section provides information on regulatory approvals, ensuring the device meets safety and performance requirements.

#### Regulatory Standards:

[List the standards and certifications relevant to the device.]

#### Approval Bodies:

[Specify regulatory bodies that have approved the device.]

#### Compliance Statement:

[Include a statement confirming compliance with applicable standards.]

### 9.3 Warranty Information

The warranty section outlines the terms and conditions of the product warranty. Refer to this section for details on coverage, duration, and any limitations.

#### Warranty Coverage:

Dispomed Ltd. guarantees the quality of the insPurr ventilator, providing a warranty that covers manufacturing defects for a duration of two (2) years from the date of delivery to the customer. This warranty is applicable when the product is used according to the provided instructions, and prescribed maintenance and service are diligently performed.

Dispomed shall not be held responsible for any damage, injury, or loss resulting from the use of the insPurr ventilator if, before such incidents, the product was:

1. Damaged, misused, or misapplied.
2. Repaired, altered, or modified by a person other than a Dispomed Ltd. technician or approved service personnel.
3. Not installed in strict compliance with the instructions provided by Dispomed or the applicable codes and ordinances in place.
4. Cleaned using substances that may cause damage, such as alcohol or other harmful products.
5. Used with knowledge of a pre-existing defect.

Plastic, rubber, and consumable items are guaranteed to be free of defects at the time of delivery to the customer.

Any insPurr ventilator found to be defective in workmanship or material will, at Dispomed's discretion, either be repaired or replaced. The warranty does not cover deterioration, wear, or abuse of the unit.

This warranty becomes void if the serial number of the product has been altered, defaced, or removed.

Shipping charges for any unit that needs repair or replacement are the responsibility of the customer.

## SERVICE AND INFORMATION CENTER

### Contact us at:

Toll-Free: 1-800-363-1746

Phone: 1 450 759-9395

Fax: 1 450 759-8181

Email: [info@dispomed.com](mailto:info@dispomed.com)

Website: [www.dispomed.com](http://www.dispomed.com)

### Exclusions and Limitations:

1. **Normal Wear and Tear:** The warranty does not cover the normal wear and tear that occurs with regular use of the insPurr ventilator.
2. **Consumables:** such as bellows, breathing system hose, evacuation hose, and rubber components, are excluded from warranty coverage.
3. **External Factors:** Dispomed shall not be responsible for damage, defects, or malfunctions caused by external factors such as power fluctuations, inadequate power supply, or environmental conditions beyond normal operating parameters.
4. **Unauthorized Repairs or Modifications:** Any repairs or modifications performed by unauthorized personnel or entities, other than Dispomed Ltd. technicians or approved service personnel, will void the warranty.
5. **Failure to Follow Instructions:** The warranty is not applicable if the insPurr ventilator is not used in accordance with the instructions provided by Dispomed or if prescribed maintenance and service are neglected.
6. **Use of Unauthorized Parts or Consumables:** The warranty does not cover issues arising from the use of parts or consumables

that are not approved or recommended by Dispomed Ltd.

7. **Accidents or Misuse:** Dispomed shall not be held liable for damage, defects, or malfunctions resulting from accidents, misuse, abuse, neglect, or any other similar incidents.
8. **Third-Party Accessories:** Any damage caused by the use of third-party accessories or components not explicitly approved by Dispomed is not covered under this warranty.
9. **Serial Number Alteration:** If the serial number of the insPurr ventilator has been altered, defaced, or removed, the warranty becomes void.
10. **Consequential Damages:** Dispomed Ltd. is not liable for any consequential damages, including but not limited to, loss of revenue, loss of use, or other financial losses resulting from the use of the insPurr ventilator.
11. **Product Misuse:** The warranty does not cover damages or malfunctions caused by the intentional misuse or negligent operation of the insPurr ventilator.

These exclusions and limitations are in effect to ensure the fair and appropriate application of the warranty terms. If you have any questions or concerns regarding these exclusions and limitations, please contact Dispomed Ltd.'s Service and Information Center.

### Claims Process:

In the event that you need to initiate a warranty claim for your insPurr ventilator from Dispomed Ltd., please follow the outlined claims process:

### Contact Dispomed's Service and Information Center:

Reach out to Dispomed Ltd.'s Service and Information Center through one of the following channels:

Toll-Free: 1-800-363-1746

Phone: 1 450 759-9395

Fax: 1 450 759-8181

Email: [info@dispomed.com](mailto:info@dispomed.com)

### Provide Necessary Information:

- Clearly state your name, contact details, veterinary clinic information and the serial number of the insPurr ventilator.
- Describe the nature of the issue or defect you are experiencing.

### Follow Guidance from Dispomed's Support Team:

Dispomed's support team will guide you through initial troubleshooting steps over the phone or via email to determine the nature of the issue.

### Determination of Warranty Coverage:

If the issue is determined to be covered by the warranty, the support team will provide instructions on the next steps.

### Return Authorization (if applicable):

If a return is necessary, Dispomed's support team will issue a Return Merchandise Authorization (RMA) number and provide instructions on how to return the product.

### **Package the Product Securely:**

Ensure the insPurr ventilator is securely packaged for return shipment. Include the RMA number on the packaging.

### **Shipping Instructions:**

Follow the shipping instructions provided by Dispomed's support team. Note that shipping charges for the return are the responsibility of the customer.

### **Loaner Unit (if applicable):**

If available, Dispomed may offer a loaner unit to use during the repair period.

### **Evaluation and Repair/Replacement:**

Dispomed's technicians will evaluate the insPurr ventilator and, at their discretion, either repair or replace the unit.

### **Return Shipment:**

Once the repair or replacement is completed, Dispomed will arrange for the return shipment of the insPurr ventilator.

### **Final Checks:**

Upon receiving the repaired or replaced unit, perform final checks to ensure the issue has been resolved.

## **9.4 Accessories**

- Filter assembly 945-0500-0012
- Belows 945-0500-0012
- Belows housing 945-0500-0122
- Belows housing o'ring 945-0500-0122
- Mushroom valve 945-0500-0039
- 22mm smooth bore tube 940-0260-210
- Evacuation tube 985-0065-000
- Y evacuation 985-0070-000
- 30mm to 19mm evacuation raccord 985-3570772
- Tee airway pressure 945-0500-0026



**insPurr** Moduflex

Manufactured by Dispomed Ltd

**Thank you for purchasing a Dispomed product.**

If you have any questions, please feel free to contact customer service.

745 Nazaire-Laurin Joliette (QC) Canada J6E 0L6  
T. 1-800-363-1746 (Canada et États-Unis seulement)  
T. 1-450-759-9395  
F. 1-450-759-8181

[info@dispomed.com](mailto:info@dispomed.com)  
[www.dispomed.com](http://www.dispomed.com)

PRINTED IN CANADA

