

# HOBO® Pendant® MX Temp (MX2201) and Temp/Light (MX2202) Logger Manual



MX2201 Model Shown

## HOBO Pendant MX Logger

### Models:

- MX Temp (MX2201)
- MX Temp/Light (MX2202)

### Required Items:

- HOBOMobile app
- Device with iOS or Android™ and Bluetooth

### Accessories:

- Solar radiation shield (RS1 or M-RSA)
- Mounting bracket for solar radiation shield (MX2200-RS-BRACKET)
- Replacement O-rings (MX2201-02-ORING)

HOBO Pendant MX loggers measure temperature (MX2201) or temperature/light (MX2202) in indoor and outdoor environments. Designed for durability, these compact, waterproof loggers can be used in numerous applications, including fresh and salt water. The loggers are Bluetooth® Low Energy-enabled for wireless communication with a mobile device. Using the HOBOMobile® app, you can easily configure the loggers, download logged data to your phone or tablet, or automatically upload the data to HOBOLink® for further analysis. You can also configure the loggers to calculate statistics, set up alarms to trip at specific thresholds, or enable burst logging in which data is logged at a faster interval when sensor readings are above or below certain limits.

## Specifications



### Temperature Sensor (MX2201 and MX2202)

<b>Range</b>	-20° to 70°C (-4° to 158°F) in air -20° to 50°C (-4° to 122°F) in water
<b>Accuracy</b>	±0.5°C from -20° to 70°C (-4° to 158°F)
<b>Resolution</b>	0.04°C (0.072°F)
<b>Drift</b>	<0.1°C (0.18°F) per year
<b>Response Time</b>	17 minutes typical to 90% in air moving 1 m/s, unmounted 7 minutes typical to 90% in stirred water, unmounted

### Light Sensor (MX2202)

<b>Range</b>	0 to 167,731 lux (15,582 lum/ft <sup>2</sup> )
<b>Accuracy</b>	±10% typical for direct sunlight (see <i>Light Measurement</i> on page 2 for more details)

### Logger

<b>Logger Operating Range</b>	-20° to 70°C (-4° to 158°F) in air
<b>Buoyancy (Fresh Water)</b>	2 g (0.07 oz) positive
<b>Waterproof</b>	To 30.5 m (100 ft)
<b>Radio Power</b>	1 mW (0 dBm)
<b>Transmission Range</b>	Approximately 30.5 m (100 ft) line-of-sight
<b>Wireless Data Standard</b>	Bluetooth Low Energy (Bluetooth Smart)
<b>Logging Rate</b>	1 second to 18 hours
<b>Time Accuracy</b>	±1 minute per month at 25°C (77°F)
<b>Battery</b>	CR2032 3V lithium, user replaceable
<b>Battery Life</b>	1 year typical at 25°C (77°F) with logging interval of 1 minute and Bluetooth Always Off disabled in software. 2 years typical at 25°C (77°F) with logging interval of 1 minute and Bluetooth Always Off enabled in software. Faster logging intervals and statistics sampling intervals, burst logging, remaining connected with the app, excessive downloads, and paging may impact battery life. To ensure proper battery installation, see <i>Battery Information</i> for detailed instructions on replacing the battery.
<b>Memory</b>	96,000 measurements
<b>Full Memory Download Time</b>	Approximately 45 seconds; may take longer the farther the device is from the logger
<b>Wetted Materials</b>	Polypropylene case, EPDM O-ring
<b>Dimensions</b>	3.35 x 5.64 x 1.8 cm (1.32 x 2.22 x 0.69 inches)
<b>Weight</b>	12.75 g (0.45 oz)
<b>Environmental Rating</b>	IP68
	The CE Marking identifies this product as complying with all relevant directives in the European Union (EU).
	See last page

## Logger Components and Operation

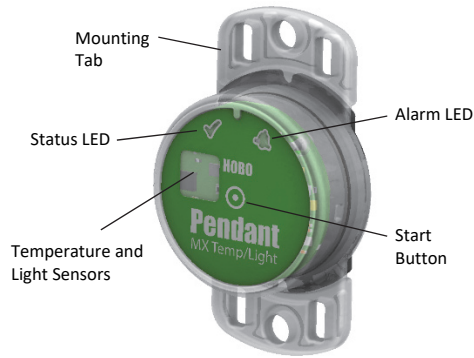

MX2202 model shown

**Mounting Tab:** Use the tabs at the top and bottom of the logger to mount it (see *Deploying and Mounting the Logger*).

**Temperature and Light Sensors:** The temperature sensor (MX2201 and MX2202) and light sensor (MX2202) are located on the right side of the logger. See *Light Measurement* for more details on the light sensor.

**Status LED:** This LED blinks green every 4 seconds when the logger is logging (unless Show LED is disabled as described in *Configuring the Logger*). If the logger is waiting to start logging because it was configured to start “On Button Push” or with a delayed start, it will blink green every 8 seconds. Both this LED and the Alarm LED will blink once when you press the start button to wake up the logger before configuring it. If you select Page Logger LED in the HOBOMobile app, both LEDs will be illuminated for 5 seconds.

**Alarm LED:** This LED blinks red every 4 seconds when an alarm is tripped (unless Show LED is disabled as described in *Configuring the Logger*).

**Start Button:** Press the circle on the front of the logger case for 1 second to wake up the logger (unless Bluetooth Always Off is disabled as described in *Configuring the Logger*). Both LEDs will blink and the logger will move to the top of the loggers list in HOBOMobile. You may need to press the button a second time to wake up the logger if it is logging every 5 seconds or faster and the temperature is  $-10^{\circ}\text{C}$  ( $14^{\circ}\text{F}$ ) or below. Press this circle for 3 seconds to start or stop the logger when it is configured to start or stop “On Button Push” (see *Configuring the Logger*). Both LEDs will blink four times when you press the circle to start or stop logging. Press this circle for 10 seconds to reset a password. **Note:** The circle on the front of the logger represents the button area on the logger. You will not feel an actual button push when you press that area; this is normal.

## Light Measurement (MX2202)

The logger measures light intensity in units of lumens/ft<sup>2</sup> or lux. The light sensor in the MX2202 has a spectral response that tightly matches the photopic response of the human eye. This is shown in Plot A.

The light sensor has range of 0 to 167,731 lux (15,582 lum/ft<sup>2</sup>). The resolution of the light measurement varies from 1 unit of lux or lum/ft<sup>2</sup> in very dim light to 40 lux (4 lum/ft<sup>2</sup>) for a full scale measurement.

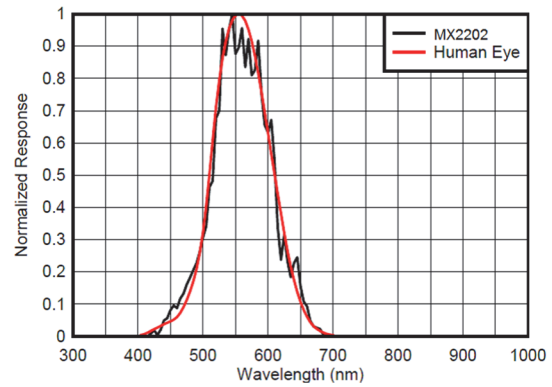

Plot A

## Light Measurement Accuracy

Although the MX2202 is factory calibrated to account for the light attenuation of the plastic enclosure, you may notice a significant difference in the MX2202 reading compared to a commercially available lux meter. Ideally, a light meter’s response should be proportional to the cosine of the angle at which the light is incident. The MX2202 does not collect light exactly according to this rule. Plot B illustrates the difference between an ideal cosine response and the approximate response of the MX2202. For example, given an incident angle of 60°, the MX2202 response is 40% lower than the ideal response. The MX2202 is calibrated to give best results for direct illumination, but this is not always the case.

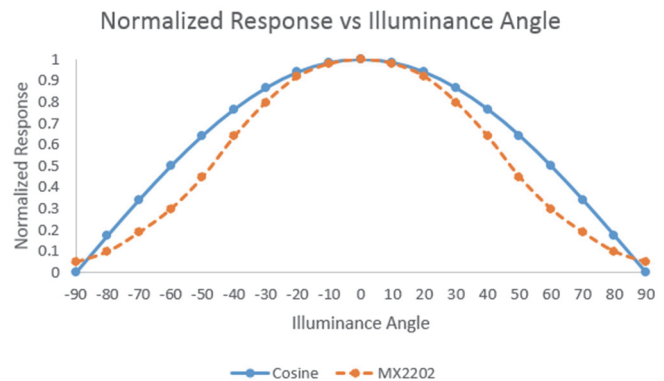

Plot B

## Getting Started

Install the HOBOMobile app to connect to and work with the logger.

1. Download the HOBOMobile app from the App Store® or Google Play™.
2. Open the app and enable Bluetooth in the device settings if prompted.
3. Firmly press the circular button near the center of the logger to wake it up. Both LEDs on the logger will blink once when it wakes up.
4. Tap the HOBOMobile icon (on Android devices) or tap the Devices icon and then tap Loggers at the top of the screen (on Apple® devices). Tap the logger in the list to connect to it.



If the logger does not appear in the list or if it is having trouble connecting, follow these tips.

- Make sure the logger is “awake” by pressing the circle on the case. The alarm and status LEDs will blink once when the logger wakes up. This will also bring the logger to the top of the list if you are working with multiple loggers.
- If the logger is currently logging at a fast interval (5 seconds or faster) and the temperature is -10°C (14°F) or below, you may need to press the button twice before it appears in the list.
- Make sure the logger is within range of your mobile device. The range for successful wireless communication in air is approximately 30.5 m (100 ft) with full line-of-sight.
- Change the orientation of your phone or tablet to ensure the antenna in your device is pointed toward the logger. Obstacles between the antenna in the device and the logger may result in intermittent connections.
- If your device can connect to the logger intermittently or loses its connection, move closer to the logger, within sight if possible. If the logger is in water, the connection can be unreliable. Remove it from water for a consistent connection.
- If the logger appears in the list, but you cannot connect to it, close HOBOMobile and power cycle the mobile device. This forces the previous Bluetooth connection to close.

Once the logger is connected, you can select one of the following actions:

- **Configure.** Select logger settings and load them onto the logger to start logging. See *Configuring the Logger*.
- **Readout.** Download logger data. See *Reading Out the Logger*.
- **Full Status Details.** Check the battery level and view the configuration settings currently selected for the logger.
- **Start Logging.** Start recording data (if the logger is configured to start “On Button Push” as described in *Configuring the Logger*).
- **Stop Logging.** Stop the logger from recording data. This overrides any other Stop Logging settings that may be configured.
- **Page Logger LED.** Press and hold this option to illuminate the alarm and status LEDs for 5 seconds.
- **Logger Password.** Create a password for the logger that will be required if another mobile device attempts to connect to it. To reset a password, connect to the logger, tap Set Logger Passkey, and select Reset to Factory Default. You can also press the circle on the logger for 10 seconds to reset the password.

- **Update Firmware.** When new logger firmware is available, this action appears in the list. Select it and follow the instructions on the screen. A logger readout will be completed automatically at the beginning of the firmware update process. If the connection is lost between the logger and the mobile device during the firmware update, a Firmware Update Pending Status displays for the logger in the HOBOS list. Connect to the logger and select Restore Logger (or Update Firmware if that option is available) to continue updating the firmware.

**Important:** Before updating the firmware on the logger, check the remaining battery level by selecting Full Status Details and make sure it is no less than 30%. Make sure you have the time to complete the entire update process, which requires that the logger remains connected to the device during the upgrade.

- **Force Offload.** This may appear if an error was encountered when loading configure settings. Select this to offload all the data on the logger before reconfiguring it.

### Configuring the Logger

Use HOBOMobile to set up the logger, including selecting the logging interval, start and stop logging options, and configuring alarms. These steps provide an overview of setting up the logger. For complete details, see the *HOBOMobile User’s Guide*.

1. Open HOBOMobile and tap the HOBOS icon.
2. Press the circle on the logger to wake it up. This will also bring the logger to the top of the logger list (the logger name will turn green). Note that the current sensor readings are displayed even when the logger is not logging.
3. Once connected, tap Configure.

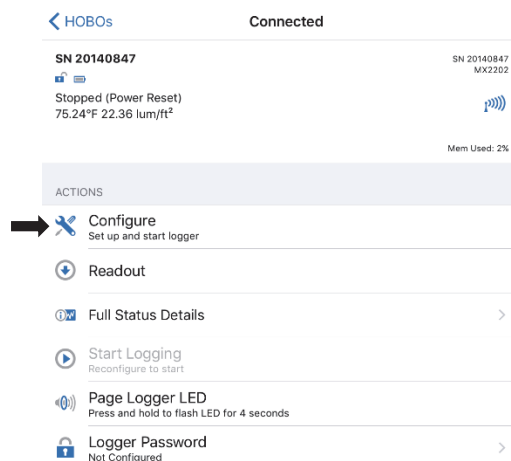

4. Tap Name and type a name for the logger up to 20 characters (optional). Tap Done. If no name is selected, the logger serial number is used as the name.
5. Tap Group to add the logger to the Favorites group, an existing custom group, or create a new group name up to 20 characters (optional). Tap Done.
6. Tap Logging Interval and choose how frequently the logger will record data.

7. Tap Start Logging and select when logging will begin:
  - **Now.** Logging will begin immediately after tapping Start in the Configure screen.
  - **On Next Logging Interval.** Logging will begin at the next even interval as determined by the selected logging interval.
  - **On Button Push.** Logging will begin once you press the circle on the logger for 3 seconds.
  - **On Date/Time.** Logging will begin at a date and time you specify. Select the Date and time and tap Done.

Tap Done in the Start Logging screen.

8. Tap Stop Logging and select the options for when logging will end.
  - a. Choose one of two memory options:
    - **When Memory Fills.** The logger will continue recording data until the memory is full.
    - **Never (Wrap When Full).** The logger will continue recording data indefinitely, with newest data overwriting the oldest.
  - b. Select On Button Push if you want to be able to stop logging by pushing the circle on the logger for 3 seconds. Note that if you also choose On Button Push for the Start Logging option, then you will not be able to stop logging until 30 seconds after logging begins.
  - c. Select one of the following time options for when to stop logging:
    - **Never.** Select this if you do not want the logger to stop at any predetermined time frame.
    - **On Date/Time.** Select this if you want the logger to stop logging on a specific date and time. Select the date and time and then tap Done.
    - **After.** Select this if you want to control how long the logger should continue logging once it starts. Choose the amount of time you want the logger to log data and then tap Done. For example, select 30 days if you want the logger to log data for 30 days after logging begins.
  - d. Tap Done in the Stop Logging screen.
9. For the Pendant MX Temp/Light (MX2202) logger, both the temperature and light sensors are enabled by default. Disable one if desired.

10. You can set up alarms to trip when a sensor reading rises above or falls below a specified value. See *Setting up Alarms* for details on enabling sensor alarms.
11. Tap Logging Mode. Select either fixed interval logging or burst logging. With fixed interval logging, the logger records data for all enabled sensors and/or selected statistics at the logging interval selected (see *Statistics Logging* for details on choosing statistics options). In burst mode, logging occurs at a different interval when a specified condition is met. See *Burst Logging* for more information. Tap Done.
12. Enable or disable Show LED. If Show LED is disabled, the alarm and status LEDs on the logger will not be illuminated

while logging (the alarm LED will not blink if an alarm trips). You can temporarily turn on LEDs when Show LED is disabled by pressing the circle on the logger for 1 second.

13. Enable or disable Bluetooth Always Off. When this option is disabled, the logger will “advertise” or regularly send out a Bluetooth signal for the phone or tablet to find via HOBOMobile while it is logging, which uses battery power. When this option is enabled, the logger will only advertise during logging when you press the circle on the logger to wake it up, thereby preserving as much battery power as possible.
14. Tap Start in the upper right corner of the Configure screen to load the settings onto the logger.



Logging will begin based on the settings you selected. See *Deploying and Mounting the Logger* for details on mounting and see *Reading Out the Logger* for details on downloading.

## Setting up Alarms

You can set up alarms for the logger so that if a sensor reading rises above or falls below a specified value, the logger alarm LED will blink and an alarm icon will appear in the app. This can alert you to problems so you can take corrective action.

To set an alarm:

1. Tap the HOBOMobile icon (on Android devices) or tap the Devices icon and then tap Loggers at the top of the screen (on Apple devices). Tap the logger to connect to it. If the logger was configured with Bluetooth Always Off enabled, press the circle on the logger to wake it up.
2. Once connected, tap Configure.
3. In Sensor & Alarm Setup, tap an enabled sensor.
4. Enable the High Alarm if you want an alarm to trip when the sensor reading rises above the high alarm value. Drag the slider to the reading that will trip the alarm or tap the value field and type a specific reading. In the example, an alarm will trip when the temperature rises above 85°F.

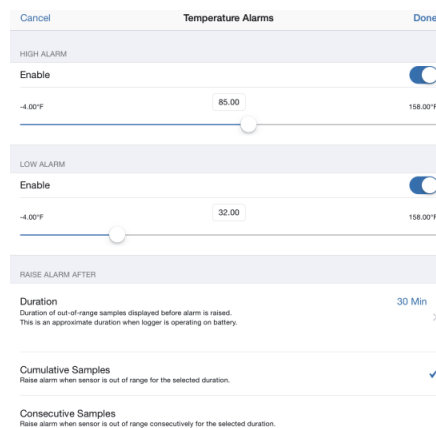

5. Enable the Low Alarm if you want an alarm to trip when the sensor reading falls below the low alarm value. Drag the slider to the reading that will trip the alarm or tap the value field and type a specific reading. In the example, an alarm is configured to trip when the temperature falls below 32°F.
6. Under Raise Alarm After, select the duration before an alarm is tripped and tap Done in the Alarm Duration screen.
7. Select either Cumulative or Consecutive Samples. If you select Cumulative Samples, then the alarm will trip when the time the sensor is out of range over the course of the deployment is equal to the selected duration. If you select Consecutive Samples, then the alarm will trip when the time the sensor is continuously out of range is equal to the selected duration. For example, the high alarm for temperature is set to 85°F and the duration is set to 30 minutes. If Cumulative is selected, then an alarm will trip once a sensor reading has been at or above 85°F for a total of 30 minutes since the logger was configured; specifically, this could be 15 minutes above 85°F in the morning and then 15 minutes above 85°F again in the afternoon. If Consecutive is selected, then an alarm will trip only if all sensor readings are 85°F or above for a continuous 30-minute period.
8. Tap Done and repeat steps 3–8 for the other sensor in the Pendant MX Temp/Light (MX2202) logger if desired. Note that when both alarms are configured, an alarm is raised when either sensor is in an alarm condition.
9. Back in the Configure screen, select one of the following options to determine how the alarm indications are cleared:
  - **Logger Reconfigured.** The alarm indication will display until the next time the logger is reconfigured.
  - **Sensor in Limits.** The alarm icon indication will display until the sensor reading returns to the normal range between any configured high and low alarm limits.
10. Tap Start in the Configure screen to load the alarm settings onto the logger if you are ready to start.

When an alarm trips, the logger alarm LED blinks every 4 seconds (unless Show LED is disabled), an alarm icon appears in the app, and an Alarm Tripped event is logged. The alarm state will clear when the readings return to normal if you selected Sensor in Limits in step 9. Otherwise, the alarm state will remain in place until the logger is reconfigured.

#### Notes:

- Alarm limits are checked at every logging interval. For example, if the logging interval is set to 5 minutes, then the logger will check the sensor readings against your configured high and low alarm setting every 5 minutes.
- The actual values for the high and low alarm limits are set to the closest value supported by the logger. For example, the closest value to 85°F that the logger can record is 84.990°F. In addition, alarms can trip or clear when the sensor reading is within the specified resolution. This means the value that triggers the alarm may differ slightly than the value entered. For example, if the High Alarm is set to 75.999°F, the alarm can trip when the sensor reading is 75.994°F, which is within the range of the resolution specifications.

- When you read out the logger, alarm events can be displayed on the plot or in the data file. See *Logger Events*.

## Burst Logging

Burst logging is a logging mode that allows you to set up more frequent logging when a specified condition is met. For example, a logger is recording data at a 5-minute logging interval and burst logging is configured to log every 30 seconds when the temperature rises above 85°F (the high limit) or falls below 32°F (the low limit). This means the logger will record data every 5 minutes as long as the temperature remains between 85°F and 32°F. Once the temperature rises above 85°F, the logger will switch to the faster logging rate and record data every 30 seconds until the temperature falls back to 85°F. At that time, logging then resumes every 5 minutes at the normal logging interval. Similarly, if the temperature falls below 32°F, then the logger would switch to burst logging mode again and record data every 30 seconds. Once the temperature rises back to 32°F, the logger will then return to normal mode, logging every 5 minutes. **Note:** Sensor alarms, statistics, and the Stop Logging option “Wrap When Full” are not available in burst logging mode.

To set up burst logging:

1. Tap the HOBOS icon (on Android devices) or tap the Devices icon and then tap Loggers at the top of the screen (on Apple devices). Tap the logger to connect to it. If the logger was configured with Bluetooth Always Off enabled, press the circle on the logger to wake it up.
2. Once connected, tap Configure.
3. Tap Logging Mode and then tap Burst Logging.
4. Tap a sensor under Burst Sensor Limits.
5. Enable High Limit if you want burst logging to occur when the sensor reading rises above a specific reading. Drag the slider to the reading that will trigger burst logging or tap the value field and type a specific reading. In the example, the logger will switch to burst logging when the temperature rises above 85°F.

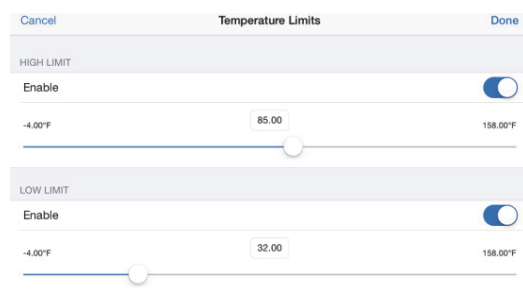

6. Enable Low Limit if you want burst logging to occur when the sensor reading falls below a specific reading. Drag the slider to the reading that will trigger burst logging or tap the value field and type a specific reading. In the example, the logger will switch to burst logging when the temperature falls below 32°F.
7. Tap Done and repeat steps 4–7 for the other sensor in the Pendant MX Temp/Light (MX2202) logger if desired.



8. Tap Burst Logging Interval and select an interval faster than the logging interval. Keep in mind that the faster the burst logging rate, the greater the impact on battery life and the shorter the logging duration. Because measurements are being taken at the burst logging interval throughout the deployment, the battery usage is similar to what it would be if you had selected this rate for the normal logging interval. Tap Done.
9. Tap Done to exit the Logging Mode screen.
10. Tap Start in the Configure screen to load the burst settings onto the logger if you are ready to start.

#### Notes:

- The high and low burst limits are checked at the burst logging interval rate whether the logger is in normal or burst condition. For example, if the logging interval is set to 1 hour and the burst logging interval is set to 10 minutes, the logger will always check for burst limits every 10 minutes.
- If high and/or low limits have been configured for more than one sensor, then burst logging will begin when any high or low condition goes out of range. Burst logging will not end until all conditions on all sensors are back within normal range.
- The actual values for the burst logging limits are set to the closest value supported by the logger. For example, the closest value to 85°F that the logger can record is 84.990°F. In addition, burst logging can begin or end when the sensor reading is within the specified resolution. This means the value that triggers burst logging may differ slightly than the value entered. For example, if the high limit for a temperature alarm is set to 75.999°F, burst logging can start when the sensor reading is 75.994°F, which is within the range of the resolution specifications.
- Once the high or low condition clears, the logging interval time will be calculated using the last recorded data point in burst logging mode, not the last data point recorded at the normal logging rate. For example, the logger has a 10-minute logging interval and logged a data point at 9:05. Then, the high limit was surpassed and burst logging began at 9:06. Burst logging then continued until 9:12 when the sensor reading fell back below the high limit. Now back in normal mode, the next logging interval will be 10 minutes from the last burst logging point, or 9:22 in this case. If burst logging had not occurred, the next data point would have been at 9:15.
- A New Interval event is created each time the logger enters or exits burst logging mode. See *Logger Events* for details on plotting and viewing the event. In addition, if the logger is stopped with a button push while in burst logging mode, then a New Interval event is automatically logged and the burst condition is cleared, even if the actual high or low condition has not cleared.

## Statistics Logging

During fixed interval logging, the logger records data for enabled sensors and/or selected statistics at the logging interval selected. Statistics are calculated at a sampling rate you

specify with the results for the sampling period recorded at each logging interval. The following statistics can be logged for each sensor:

- The maximum, or highest, sampled value,
- The minimum, or lowest, sampled value,
- An average of all sampled values, and
- The standard deviation from the average for all sampled values.

For example, a Pendant MX Temp/Light (MX2202) logger is configured with both the temperature and light sensors enabled, and the logging interval set to 5 minutes. The logging mode is set to fixed interval logging with Normal and all four statistics enabled and with a statistics sampling interval of 30 seconds. Once logging begins, the logger will measure and record the actual temperature and light values every 5 minutes. In addition, the logger will take a temperature and light sample every 30 seconds and temporarily store them in memory. The logger will then calculate the maximum, minimum, average, and standard deviation using the samples gathered over the previous 5-minute period and log the resulting values. When reading out the logger, this would result in 10 data series: two sensor series (with temperature and light data logged every 5 minutes) plus eight maximum, minimum, average, and standard deviation series (four for temperature and four for light with values calculated and logged every 5 minutes based on the 30-second sampling).

To log statistics:

1. Tap the HOBOS icon (on Android devices) or tap the Devices icon and then tap Loggers at the top of the screen (on Apple devices). Tap the logger to connect to it. If the logger was configured with Bluetooth Always Off enabled, press the circle on the logger to wake it up.
2. Once connected, tap Configure.
3. Tap Logging Mode and then select Fixed Interval Logging.
4. Select Normal to record the current reading for each enabled sensor at the logging interval shown at the top of the screen. Do not select this if you only want to log statistics.
5. Select the statistics you want the logger to record at each logging interval: Maximum, Minimum, Average, and Standard Deviation (average is automatically enabled when selecting Standard Deviation). Statistics will be logged for all enabled sensors. In addition, the more statistics you record, the shorter the logger duration and the more memory is required.
6. Tap Statistics Sampling Interval and select the rate to use for calculating statistics. The rate must be less than, and a factor of, the logging interval. For example, if the logging interval is 1 minute and you select 5 seconds for the sampling rate, then the logger will take 12 sample readings between each logging interval (one sample every 5 seconds for a minute) and use the 12 samples to record the resulting statistics at each 1-minute logging interval. Note that the faster the sampling rate, the greater the impact on battery life. Because measurements are being taken at the statistics sampling interval throughout the deployment, the battery

usage is similar to what it would be if you had selected this rate for the normal logging interval.

7. Tap Done.
8. Tap Done again to exit the Logging Mode screen.
9. Tap Start in the Configure screen to load the statistics settings onto the logger if you are ready to start.

## Setting a Password

You can create an encrypted password for the logger that will be required if another phone or tablet attempts to connect to it. This is recommended to ensure that a deployed logger is not mistakenly stopped or purposely altered by others. This password uses a proprietary encryption algorithm that changes with every connection.

To set a password:

1. Tap the HOBOS icon (on Android devices) or tap the Devices icon and then tap Loggers at the top of the screen (on Apple devices). Tap the logger to connect to it. If the logger was configured with Bluetooth Always Off enabled, press the circle on the logger to wake it up.
2. Tap Logger Password.
3. Type a password up to 10 characters.
4. Tap Save.

Only the phone or tablet used to set the password can then connect to the logger without entering a password; all other mobile devices will be required to enter the password. For example, if you set the password for the logger with your tablet and then try to connect to the device later with your phone, you will be required to enter the password on the phone but not with your tablet. Similarly, if others attempt to connect to the logger with different devices, then they would also be required to enter the password. To reset a password, connect to the logger, tap Set Logger Passkey, and select Reset to Factory Default or press the circle on the logger for 10 seconds.



## Reading Out the Logger

To download data from the logger:

1. Press the circle on the logger to wake it up (unless it was configured with Bluetooth Always Off disabled).
2. Tap the HOBOS icon (on Android devices) or tap the Devices icon and then tap Loggers at the top of the screen (on Apple devices). Tap the logger to connect to it.
3. Once connected, tap Readout.
4. Tap the Data Files icon to view a mini-graph of the downloaded data.
5. Tap the mini-graph to view a larger version of the graph or to share the file. See the *HOBOMobile User's Guide* for details on viewing graphs and sharing data.

Data can also be uploaded automatically to HOBOLink, Onset's web-based software, via HOBOMobile or the HOBO MX Gateway. For details on uploading data to HOBOLink, see the *HOBOMobile User's Guide*.

## Logger Events

The logger records the following events to track logger operation and status. To plot events in HOBOMobile, tap a mini-graph and then tap . Select the events you wish to plot and then tap  again. You can also view events in shared or exported data files.

Event Name	Definition
Host Connect	The logger was connected to a mobile device.
Started	The logger started logging.
Stopped	The logger stopped logging.
Chan <#> Alarm Tripped/Cleared	An alarm has occurred because the reading was outside the alarm limits or back within range. <b>Note:</b> Although the reading may return to a normal range, an alarm cleared event will not be logged if the logger was set up to maintain alarms until reconfigured.
Button Up/Down	The circle on the logger was pressed to wake it up/bring it to the top of the loggers list in HOBOMobile.
New Interval	The logger has switched to logging at the burst logging rate or back to the normal rate.
Power Warn	The battery level dropped below 2.3 V.
Safe Shutdown	The battery level dropped below a safe operating voltage and performed a safe shutdown.

## Deploying and Mounting the Logger

Follow these guidelines for deploying and mounting the logger.

- The logger must be mounted to a flat surface to prevent the logger housing from bowing. You can deploy the logger by using the two mounting tabs. Insert two screws through the holes on the mounting tabs to affix the logger to a flat surface. Do not mount the logger to a pipe, pole, or in any other way that may cause the logger housing to bow over time.



- When deploying in water, the logger should be appropriately weighted, secured, and protected depending on water conditions and desired measurement location.
- Loggers deployed in direct sunlight will heat up so that temperature readings are warmer than the ambient temperature. Use a solar radiation shield to ensure

temperature readings represent the ambient temperature.

Attach the logger to a solar radiation shield (RS1 or M-RSA) using the solar radiation shield bracket (MX2200-RS-BRACKET). Attach the logger to the underside of the mounting plate as shown in the following example. For more details on the solar radiation shield, refer to the *Solar Radiation Shield Installation Guide* at [www.onsetcomp.com/manuals/rs1](http://www.onsetcomp.com/manuals/rs1). **Note:** To log both temperature and sunlight, you will need two MX2202 loggers. Place one logger in a solar radiation shield to log temperature and the other mounted flat on top of the solar radiation shield to record sunlight.

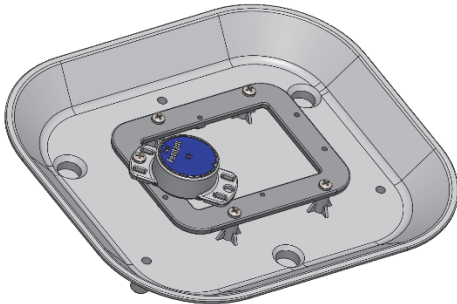

- When measuring light intensity outdoors or underwater, make sure the MX2202 logger is mounted horizontally so that the light sensor is pointing straight up towards the sky as shown in this example.

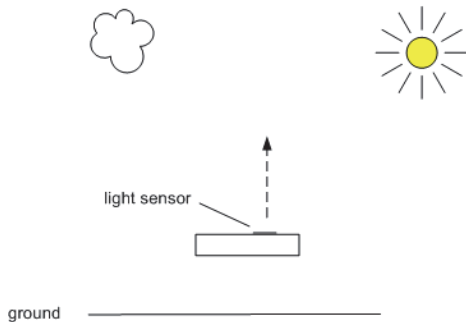

- Be careful of solvents. Check a materials compatibility chart against the wetted materials listed in the Specifications table before deploying the logger in locations where untested solvents are present. The logger has an EPDM O-ring, which is sensitive to polar solvents (acetone, keton) and oils.

## Maintaining the Logger

- To clean the logger, rinse it in warm water. Use a mild dishwashing detergent if necessary. Do not use harsh chemicals, solvents, or abrasives.
- Periodically inspect the logger for biofouling if it is deployed in water and clean as described.
- Periodically inspect the O-ring on the inside of the battery cover for cracks or tears and replace it if any are detected (MX2201-02-ORING). See *Battery Information* for steps on replacing the O-ring.

## Protecting the Logger

**Note: Static electricity may cause the logger to stop logging.**

The logger has been tested to 8 KV, but avoid electrostatic discharge by grounding yourself to protect the logger. For more information, search for “static discharge” on [www.onsetcomp.com](http://www.onsetcomp.com).

## Battery Information

The logger requires one user-replaceable CR2032 3V lithium battery. Battery life is 1 year typical at 25°C (77°F) with a logging interval of 1 minute and Bluetooth Always Off disabled or 2 years typical at 25°C (77°F) when the logger is configured with Bluetooth Always Off enabled. Expected battery life varies based on the ambient temperature where the logger is deployed, the logging interval, the frequency of connections, downloads, and paging, and the use of burst mode or statistics logging. Deployments in extremely cold or hot temperatures or a logging interval faster than one minute can impact battery life. Estimates are not guaranteed due to uncertainties in initial battery conditions and operating environment.

To replace the battery:

1. While pushing down with both thumbs on the back of the logger, rotate the battery cover counterclockwise until it stops moving (about a 1/8 turn).

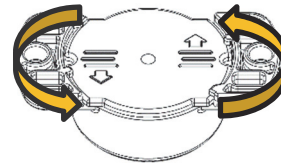

2. Use the edge below the arrow on the cover to lift it off the logger.

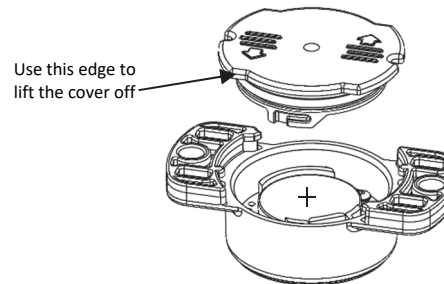

3. Remove the battery and place a new one in the battery holder, positive side facing up. Use a small flat-head screwdriver to carefully pop the battery out of its holder as shown.

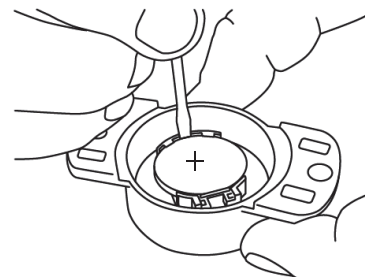

4. Inspect the O-ring on the battery cover. Make sure it is clean and seated properly. Remove any dirt, lint, hair, or



debris from the O-ring. If the O-ring has any cracks or tears, replace it as follows:

- a. Spread a small dot of silicone-based grease on the O-ring with your fingers, making sure the entire O-ring surface is completely covered in grease.
  - b. Place the O-ring on the cover and clean off any debris. Make sure the O-ring is fully seated and level in the groove and not pinched or twisted. This is necessary to maintain a waterproof seal.
5. Place the cover back on the logger as shown, aligning the notches in the cover with the rounded tabs on the logger case. The cover will not close properly and maintain a waterproof seal if it is misaligned.

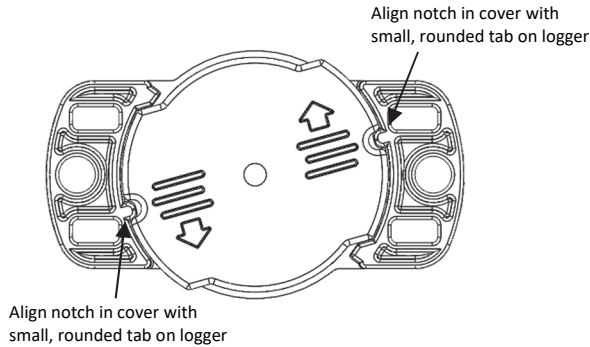

6. While pushing down with both thumbs, rotate the battery cover clockwise until it locks in position under the two large corner tabs and the two small rounded tabs.

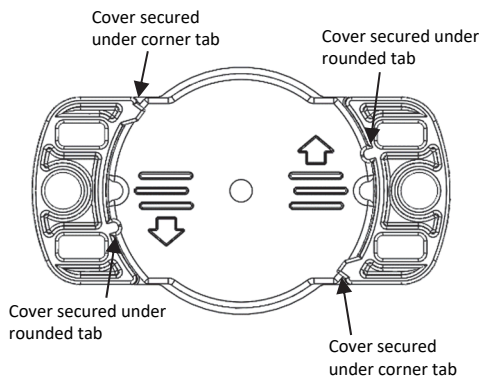

**⚠ WARNING:** Do not cut open, incinerate, heat above 85°C (185°F), or recharge the lithium battery. The battery may explode if the logger is exposed to extreme heat or conditions that could damage or destroy the battery case. Do not dispose of the logger or battery in fire. Do not expose the contents of the battery to water. Dispose of the battery according to local regulations for lithium batteries.

---

**Federal Communication Commission Interference Statement**

This equipment has been tested and found to comply with the limits for a Class B digital device, pursuant to Part 15 of the FCC Rules. These limits are designed to provide reasonable protection against harmful interference in a residential installation. This equipment generates uses and can radiate radio frequency energy and, if not installed and used in accordance with the instructions, may cause harmful interference to radio communications. However, there is no guarantee that interference will not occur in a particular installation. If this equipment does cause harmful interference to radio or television reception, which can be determined by turning the equipment off and on, the user is encouraged to try to correct the interference by one of the following measures:

- Reorient or relocate the receiving antenna
- Increase the separation between the equipment and receiver
- Connect the equipment into an outlet on a circuit different from that to which the receiver is connected
- Consult the dealer or an experienced radio/TV technician for help

This device complies with Part 15 of the FCC Rules. Operation is subject to the following two conditions: (1) This device may not cause harmful interference, and (2) this device must accept any interference received, including interference that may cause undesired operation.

**FCC Caution:** Any changes or modifications not expressly approved by the party responsible for compliance could void the user's authority to operate this equipment.

**Industry Canada Statements**

This device complies with Industry Canada license-exempt RSS standard(s). Operation is subject to the following two conditions: (1) this device may not cause interference, and (2) this device must accept any interference, including interference that may cause undesired operation of the device.

**Avis de conformité pour l'Industrie Canada**

Le présent appareil est conforme aux CNR d'Industrie Canada applicables aux appareils radio exempts de licence. L'exploitation est autorisée aux deux conditions suivantes : (1) l'appareil ne doit pas produire de brouillage, et (2) l'appareil doit accepter tout brouillage radioélectrique subi, même si le brouillage est susceptible d'en compromettre le fonctionnement.

To comply with FCC and Industry Canada RF radiation exposure limits for general population, the logger must be installed to provide a separation distance of at least 20cm from all persons and must not be co-located or operating in conjunction with any other antenna or transmitter.

**KC Statement**

해당 무선설비는 전파혼신 가능성이 있으므로 인명안전과 관련된 서비스는 할 수 없음

**Translation:**

The service related to human safety is not allowed because this device may have the possibility of the radio interference.