



PIRANHA FLEX™

HYDRAULICS

A Complete Line of Thermoplastic Hydraulic / Specialty Hoses & Fittings



EDITION 0418



Kuriyama of America, Inc.

Visit us
www.kuriyama.com
On the Web!



Hose

100R3 (meets or exceeds):

NEW PF151R3 Series.....	3
NEW PF415CP Series.....	4

100R7:

PF267/PF267NC Series.....	9
PF354/PF354NC Series.....	5
PF367/PF367NC Series.....	8
PFAN388NC Series.....	10
PFP354 Series.....	6
PFP354NC Series.....	7
PFLT364 Series.....	11

100R8:

PF628/PF628NC Series.....	12
---------------------------	----

100R18:

PF427/PF427NC Series.....	13
---------------------------	----

Specialty:

NEW PF321TC Series.....	16
NEW PF344LMT Series.....	17

Custom Twin Line.....	15
-----------------------	----

Twin Line.....	14
----------------	----

Ferrules

NEW H1200TX2/AFX Non Skive.....	18
PFR/PFR7.....	18
NEW PFR3.....	18

Standard Inserts

JIC Female 37° Seat.....	21
JIC Female 37° Seat - Double Hex.....	22
JIC Solid Male 37° Seat.....	21
JIS Female Swivel 30° Seat.....	22
NPTF Solid Male 60° Seat.....	19
NPTF Male Swivel 60° Seat.....	19
NPTF Solid Female Rigid.....	20
NPSM Female Swivel 60° Seat.....	20
SAE Solid Male O-Ring Boss.....	20

Additional Inserts

Assorted Fitting Connections.....	24
-----------------------------------	----

Stainless Steel One-Piece Fittings

NEW JIC Female 37° Seat.....	23
NEW NPTF Solid Male 60° Seat.....	23
NEW SAE Solid Male O-Ring Boss.....	23

Assembly Equipment and Accessories

Hose Cutters.....	27
P400 Hose Press.....	25
P402 Tooling.....	26

PF151R3 Series



Braided High Tensile Strength Fiber Reinforcement

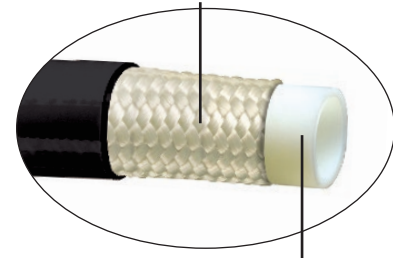

Specialty Grade Nylon

Applications:

Piranha Hose Products PF151R3 Series hose is used in general purpose low pressure hydraulic applications. This hose is intended for use in common industrial hydraulic, construction, material handling and agricultural equipment applications.

Construction:

Piranhaflex™ PF151R3 Series hose consists of three individual components bonded to ensure maximum performance.

Tube – Specialty grade nylon.

Reinforcement – Braided high tensile strength fiber reinforcement.

Cover – PF151R3 Series hose has a black abrasion resistant polyurethane pin pricked cover.

Features:

- PF151R3 Series meets or exceeds SAE 100R3 performance and requirements
- The cover is a specially formulated; smooth, seamless, perforated, polyurethane compound

Packaging:

- Hoses supplied in 250 ft. reels. All reels will have no more than 2 pieces, with no piece less than 50' in length.
- All non-standard lengths are treated as a made-to-order item and will require a minimum of 5,000 ft. to manufacture.

Working pressure for this hose series is a constant 1,500 psi in every size
 Temperature Range: -40°F (-40°C) to +200° F (+93°C) for petroleum based hydraulic fluids.

Nominal Specifications

Series Number	Size Code	Nominal ID		Nominal OD		Max. Working Pressure (psi)	Min. Bend. Radius		Approx. Weight (lbs./ft.)	Coupling Recommendations
		(in.)	(mm)	(in.)	(mm)		(in.)	(mm)		
PF151R3	04	1/4	6.4	0.410	10.4	1,500	1.50	38.1	0.05	PFR3-04
PF151R3	05	5/16	8.1	0.520	13.2	1,500	1.75	44.5	0.07	PFR3-05
PF151R3	06	3/8	9.7	0.610	15.5	1,250	2.50	63.5	0.10	PFR3-06
PF151R3	08	1/2	13.1	0.750	19.05	1,000	3.00	76.2	0.12	PFR3-08

Freight: Hydraulic Hose can be combined with other KOA products for qualifying prepaid freight orders.

Because we continually examine ways to improve our products, we reserve the right to alter specifications or discontinue products without prior notice.

PF415CP Series



Applications:

Piranha Hose Products PF415CP Series hose is used in general purpose low pressure hydraulic applications. This hose is intended for use in common industrial hydraulic, construction, material handling and agricultural equipment applications.

Construction:

Piranhaflex™ PF415CP Series hose consists of three individual components bonded to ensure maximum performance.

Tube – Specialty grade nylon.

Reinforcement – Braided high tensile strength fiber reinforcement.

Cover – PF415CP Series hose has a black abrasion resistant polyurethane pin pricked cover.

Working pressure for this hose series is a constant 1,500 psi in every size
Temperature Range: -40°F (-40°C) to +200° F (+93°C) for petroleum based hydraulic fluids.

Features:

- PF415CP Series is a constant 1,500 PSI working pressure in all sizes
- The cover is a specially formulated; smooth, seamless, perforated, polyether polyurethane compound

Packaging:

- Hoses supplied in 250 ft. reels. All reels will have no more than 2 pieces, with no piece less than 50' in length.
- All non-standard lengths are treated as a made-to-order item and will require a minimum of 5,000 ft. to manufacture.

Nominal Specifications

Series Number	Size Code	Nominal ID		Nominal OD		Max. Working Pressure (psi)	Min. Bend. Radius		Approx. Weight (lbs./ft.)	Coupling Recommendations
		(in.)	(mm)	(in.)	(mm)		(in.)	(mm)		Two-Piece Couplings
										Ferrule Non-Skive
PF415CP	04	1/4	6.4	0.410	10.4	1,500	1.50	38.1	0.05	PFR3-04
PF415CP	05	5/16	8.1	0.520	13.2	1,500	1.75	44.5	0.07	PFR3-05
PF415CP	06	3/8	9.7	0.610	15.5	1,500	2.50	63.5	0.10	PFR3-06
PF415CP	08	1/2	13.1	0.750	19.05	1,500	3.00	76.2	0.12	PFR3-08

Freight: Hydraulic Hose can be combined with other KOA products for qualifying prepaid freight orders.

PF354/PF354NC Series



Braided High Tensile Strength Fiber Reinforcement

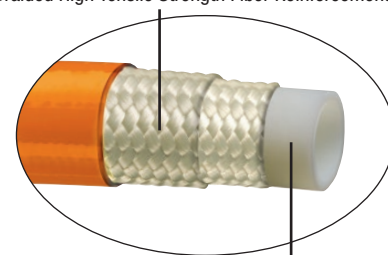

Seamless Nylon Inner Tube



Applications:

Piranhaflex™ PF354 and PF354NC Series hoses (for non-conductive applications) are ideal for medium pressure hydraulic hose applications for hydraulic oil and lubrication lines.

Construction:

Piranhaflex™ PF354 & PF354NC Series hoses consist of three individual components bonded to ensure maximum performance.

Tube — Seamless nylon inner tube.

Reinforcement — Braided high tensile strength fiber reinforcement.

Cover — PF354 Series hose has a black abrasion resistant polyurethane pin picked cover; PF354NC Series hose has an Orange non-conductive (REACH Compliant), non-pin picked abrasion resistant polyurethane cover.

Features:

- Meets or exceeds SAE J517 Standards
- Tested at ½ bend radius under SAE Standards
- Exceeds 100R7 impulse requirements
- Light weight and flexible
- Ideal for general hydraulic services

Packaging:

- Hoses supplied in 250 ft. reels & 50 ft. box lengths. All reels will have no more than 2 pieces, with no piece less than 50' in length.
- All 50' boxes contain only 1 piece of hose.
- -16 MTO is available upon request.
- All non-standard lengths are treated as a made-to-order item and will require a minimum of 5,000 ft. to manufacture.
- For Twin Line please refer to page 14 for available stock sizes.

Temperature Range: -40°F (-40°C) to +200° F (+93°C) for petroleum based hydraulic fluids.

Nominal Specifications

Series Number	Size Code	Nominal ID		Nominal OD		Max. Working Pressure (psi)	Min. Bend. Radius		Approx. Weight (lbs./ft.)	Coupling Recommendations
		(in.)	(mm)	(in.)	(mm)		(in.)	(mm)		Two-Piece Couplings
PF354/PF354NC	02	1/8	3.6	0.322	8.2	3,000	0.75	19	0.03	* F02NPT2
PF354/PF354NC	03	3/16	4.8	0.415	10.5	3,000	0.75	19	0.05	PFR-03
PF354/PF354NC	04	1/4	6.4	0.496	12.6	2,750	1.50	38	0.06	PFR-04
PF354/PF354NC	05	5/16	8.1	0.580	14.7	2,500	1.75	44	0.08	PFR7-05
PF354/PF354NC	06	3/8	9.7	0.650	16.5	2,250	2.00	51	0.11	PFR-06
PF354/PF354NC	08	1/2	13.1	0.834	21.2	2,000	3.00	76	0.16	PFR-08
PF354/PF354NC	12	3/4	19.1	1.050	26.7	1,250	6.00	152	0.22	PFR-12

* Note: One-Piece fitting.

† Minimum burst pressure 4-to-1 safety factor.

Freight: Hydraulic Hose can be combined with other KOA products for qualifying prepaid freight orders.

Because we continually examine ways to improve our products, we reserve the right to alter specifications or discontinue products without prior notice.

PFP354 Series

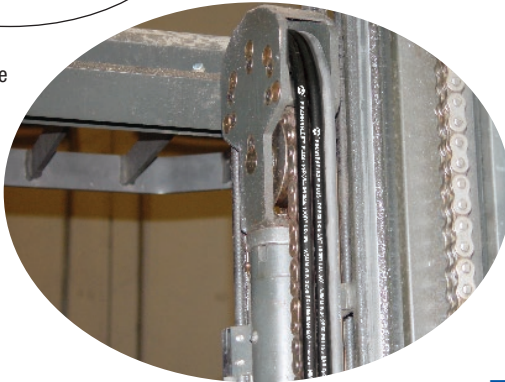
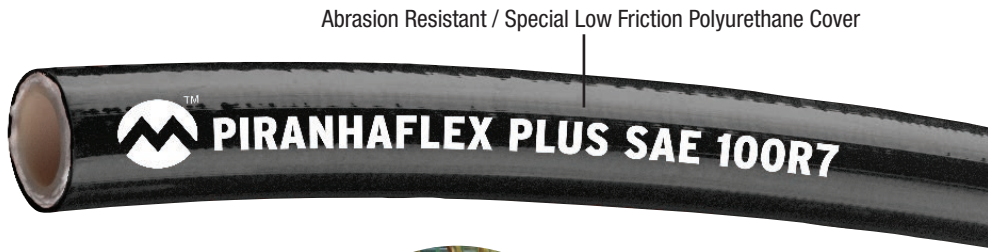
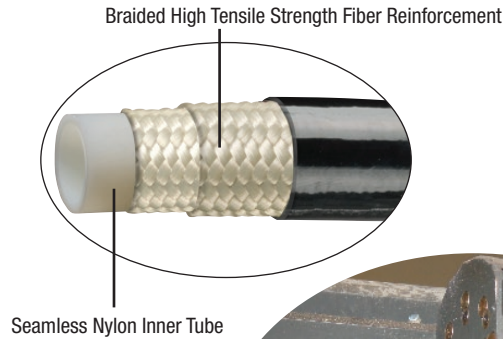

Applications:

Piranhaflex™ **PLUS** PFP354 Series hose is the ideal hose for medium pressure hydraulic lines commonly used on Fork Trucks. The “**PLUS**” refers to the specially engineered low friction cover compound which helps in eliminating hose routing problems between hose sheaves and pulleys. Use of Piranhaflex™ **PLUS** helps in extending hose service life with less frequent replacement and allows for increased flexibility and easier routing when hoses are bundled.

Construction:

Piranhaflex™ **PLUS** PFP354 Series hose consists of three individual components bonded to ensure maximum performance.

Tube – Seamless nylon inner tube.

Reinforcement – Braided high tensile strength fiber reinforcement.

Cover – PFP354 Series hose has a black abrasion resistant special low friction polyurethane pin pricked cover.

Features:

- Meets or exceeds SAE J517 Standards
- Tested at ½ bend radius under SAE Standards
- Exceeds 100R7 impulse requirements
- Light weight and flexible
- Special low friction cover eliminates hose routing problems between hose sheaves and pulleys with Fork Truck applications.

Packaging:

- Hoses supplied in 250 ft. reels. All reels will have no more than 2 pieces, with no piece less than 50' in length.
- -12 and -16 MTO are available upon request.
- All non-standard lengths are treated as a made-to-order item and will require a minimum of 5,000 ft. to manufacture.

Temperature Range: -40°F (-40°C) to +200°F (+93°C) for petroleum based hydraulic fluids.

Nominal Specifications

Series Number	Size Code	Nominal ID		Nominal OD		Max. Working† Pressure (psl)	Min. Bend. Radius		Approx. Weight (lbs./ft.)	Coupling Recommendations
		(in.)	(mm)	(in.)	(mm)		(in.)	(mm)		Two-Piece Couplings
PFP354	04	1/4	6.4	0.496	12.6	2,750	1.50	38	0.06	PFR-04
PFP354	06	3/8	9.7	0.650	16.5	2,250	2.00	51	0.11	PFR-06
PFP354	08	1/2	13.1	0.834	21.2	2,000	3.00	76	0.16	PFR-08

† Minimum burst pressure 4-to-1 safety factor.

Freight: Hydraulic Hose can be combined with other KOA products for qualifying prepaid freight orders.

Because we continually examine ways to improve our products, we reserve the right to alter specifications or discontinue products without prior notice.

PFP354NC Series

Abrasion Resistant / Special Low Friction Polyurethane Cover

Braided High Tensile Strength Fiber Reinforcement

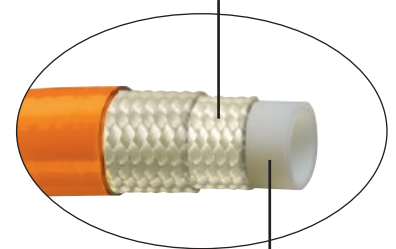

Seamless Nylon Inner Tube



Applications:

PiranhaflexTM **PLUS** "Non-Conductive" PFP354NC Series hose is the ideal hose for medium pressure hydraulic lines commonly used on utility equipment. The "**PLUS**" refers to the specially engineered low friction cover compound which helps in eliminating hose routing problems when used with utility equipment. Use of PiranhaflexTM **PLUS** helps in extending hose service life with less frequent replacement and allows for increased flexibility and easier routing when hoses are bundled.

Construction:

PiranhaflexTM **PLUS** PFP354NC Series hose consists of three individual components bonded to ensure maximum performance.

Tube – Seamless nylon inner tube.

Reinforcement – Braided high tensile strength fiber reinforcement.

Cover – PFP354NC Series hose has an Orange non-conductive (REACH Compliant), non-pin pricked abrasion resistant low friction polyurethane cover.

Features:

- Meets or exceeds SAE J517 Standards
- Tested at ½ bend radius under SAE Standards
- Exceeds 100R7 impulse requirements
- Light weight and flexible
- Special low friction cover eliminates hose routing problems with utility equipment applications.

Packaging:

- Hoses supplied in 250 ft. reels. All reels will have no more than 2 pieces, with no piece less than 50' in length.
- All non-standard lengths are treated as a made-to-order item and will require a minimum of 5,000 ft. to manufacture.

Temperature Range: -40°F (-40°C) to +200°F (+93°C) for petroleum based hydraulic fluids.

Nominal Specifications

Series Number	Size Code	Nominal ID		Nominal OD		Max. Working† Pressure (psl)	Min. Bend. Radius		Approx. Weight (lbs./ft.)	Coupling Recommendations
		(in.)	(mm)	(in.)	(mm)		(in.)	(mm)		Two-Piece Couplings
PFP354NC	04	1/4	6.4	0.496	12.6	2,750	1.50	38	0.06	PFR-04
PFP354NC	06	3/8	9.7	0.650	16.5	2,250	2.00	51	0.11	PFR-06
PFP354NC	08	1/2	13.1	0.834	21.2	2,000	3.00	76	0.16	PFR-08

† Minimum burst pressure 4-to-1 safety factor.

Freight: Hydraulic Hose can be combined with other KOA products for qualifying prepaid freight orders.

Because we continually examine ways to improve our products, we reserve the right to alter specifications or discontinue products without prior notice.

PF367/PF367NC Series

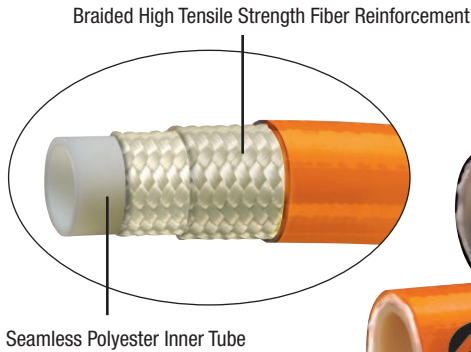

Applications:

Piranhaflex™ PF367 and PF367NC Series hoses (for non-conductive applications) are ideal for medium pressure hydraulic hose applications for hydraulic oil and lubrication lines.

Construction:

Piranhaflex™ PF367 & PF367NC Series hose consist of three individual components bonded to ensure maximum performance.

Tube — Seamless polyester inner tube.

Reinforcement — Braided high tensile strength fiber reinforcement.

Cover — PF367 Series hose has a black abrasion resistant polyurethane pin pricked cover; PF367NC Series hose has an Orange non-conductive (REACH Compliant), non-pin pricked abrasion resistant polyurethane cover.

Features:

- Meets or exceeds SAE J517 Standards
- Tested at ½ bend radius under SAE Standards
- Exceeds 100R7 impulse requirements
- Light weight and flexible
- Ideal for general hydraulic services

Packaging:

- Hoses supplied in 250 ft. reels & 50 ft. box lengths. All reels will have no more than 2 pieces, with no piece less than 50' in length.
- All 50' boxes contain only 1 piece of hose.
- -02 and -16 MTO are available upon request.
- All non-standard lengths are treated as a made-to-order item and will require a minimum of 5,000 ft. to manufacture.
- Twin/Multi Line MTO are available upon request.

Temperature Range: -40°F (-40°C) to +200°F (+93°C) for petroleum based hydraulic fluids.
-40°F (-40°C) to +140°F (+60°C) for water-based and phosphate-ester based hydraulic fluids.

Nominal Specifications

Series Number	Size Code	Nominal ID		Nominal OD		Max. Working† Pressure (psl)	Min. Bend. Radius		Approx. Weight (lbs./ft.)	Coupling Recommendations	
		(in.)	(mm)	(in.)	(mm)		(in.)	(mm)		Two-Piece Couplings	
										Ferrule Non-Skive	
PF367/PF367NC	03	3/16	4.8	0.415	10.5	3,000	0.75	19	0.05	PFR-03	
PF367/PF367NC	04	1/4	6.4	0.496	12.6	2,750	1.50	38	0.06	PFR-04	
PF367/PF367NC	05	5/16	8.1	0.580	14.7	2,500	1.75	44	0.08	PFR7-05	
PF367/PF367NC	06	3/8	9.7	0.650	16.5	2,250	2.00	51	0.11	PFR-06	
PF367/PF367NC	08	1/2	13.1	0.834	21.2	2,000	3.00	76	0.16	PFR-08	
PF367/PF367NC	12	3/4	19.1	1.050	26.7	1,250	6.00	152	0.22	PFR-12	

† Minimum burst pressure 4-to-1 safety factor.

Freight: Hydraulic Hose can be combined with other KOA products for qualifying prepaid freight orders.

Because we continually examine ways to improve our products, we reserve the right to alter specifications or discontinue products without prior notice.

PF267/PF267NC Series

Abrasion Resistant Polyurethane Cover



Braided High Tensile Strength Fiber Reinforcement

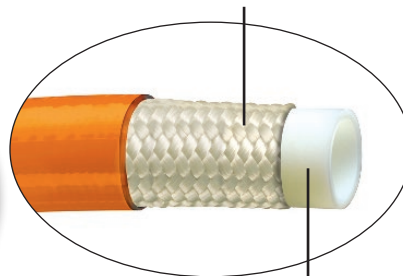

Seamless Polyester Inner Tube

Applications:

Piranhaflex™ PF267 and PF267NC Series hoses (for nonconductive applications) are ideal for medium pressure hydraulic hose applications for hydraulic oil and lubrication lines.

Construction:

Piranhaflex™ PF267 & PF267NC Series hoses consist of three individual components bonded to ensure maximum performance.

Tube – Seamless polyester inner tube.

Reinforcement – Braided high tensile strength fiber reinforcement.

Cover – PF267 Series hose has a black abrasion resistant polyurethane pin picked cover; PF267NC Series hose has an Orange non-conductive (REACH Compliant), non-pin pricked abrasion resistant polyurethane cover.

Features:

- Meets or exceeds SAE J517 Standards
- Improved flexural rigidity, up to 16% less force to bend vs competitive 100R7 type hoses
- Light weight and flexible
- Improved kink resistance, up to 53% more force required to reach kink initiation vs competitive 100R7 type hose styles
- This new hose construction facilitates installation in very tight areas

Packaging:

- Hoses supplied in 250 ft. reel lengths. All reels will have no more than 2 pieces, with no piece less than 50' in length.
- All 50' boxes contain only 1 piece of hose.
- -02 and -16 MTO are available upon request.
- All non-standard lengths are treated as a made-to-order item and will require a minimum of 5,000 ft. to manufacture.
- For Twin Line please refer to page 14 for available stock sizes.

Temperature Range: -40°F (-40°C) to +200°F (+93°C) for petroleum based hydraulic fluids.
-40°F (-40°C) to +140°F (+60°C) for water-based and phosphate-ester based hydraulic fluids.

Nominal Specifications

Series Number	Size Code	Nominal ID		Nominal OD		Max. Working† Pressure (psi)	Min. Bend. Radius		Approx. Weight (lbs./ft.)	Coupling Recommendations
		(in.)	(mm)	(in.)	(mm)		(in.)	(mm)		
PF267/PF267NC	03	3/16	4.8	0.415	10.5	3,000	0.75	19	0.05	PFR-03
PF267/PF267NC	04	1/4	6.4	0.496	12.6	2,750	1.50	38	0.07	PFR-04
PF267/PF267NC	05	5/16	8.1	0.580	14.7	2,500	1.75	44	0.09	PFR7-05
PF267/PF267NC	06	3/8	9.7	0.651	16.5	2,250	2.00	51	0.12	PFR-06
PF267/PF267NC	08	1/2	13.1	0.834	21.2	2,000	3.00	76	0.17	PFR-08
PF267/PF267NC	12	3/4	19.1	1.050	26.7	1,250	6.00	152	0.24	PFR-12

† Minimum burst pressure 4-to-1 safety factor.

Freight: Hydraulic Hose can be combined with other KOA products for qualifying prepaid freight orders.

Because we continually examine ways to improve our products, we reserve the right to alter specifications or discontinue products without prior notice.

PFAN388NC Series

Braided High Tensile Strength Fiber Reinforcement

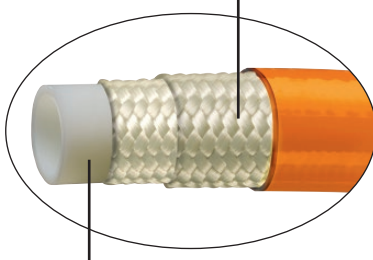

Seamless Nylon Inner Tube

Abrasion Resistant Polyurethane Cover



Applications:

Piranhaflex™ PFAN388NC Series hose is ideal for medium pressure hydraulic lines commonly used on vehicle mounted aerial devices such as Boom Trucks and Cherry Pickers. Piranhaflex™ PFAN388NC Series hose is ideal for non-conductive medium pressure hydraulic hose applications.

Construction:

Piranhaflex™ PFAN388NC Series hose consists of three individual components bonded to ensure maximum performance.

Tube – Seamless nylon inner tube.

Reinforcement – Braided high tensile strength fiber reinforcement.

Cover – PFAN388NC Series hose has an Orange non-conductive (REACH Compliant), non-pin pricked abrasion resistant polyurethane cover.

Features:

- Meets or exceeds SAE J517 100R7 Standards
- Tested at ½ bend radius under SAE Standards
- Less than 50 microamperes leakage when subjected to 75,000 volts/ft. for 5 minutes
- Complies with the ANSI 92.2 for Vehicle Mounted Aerial Devices
- Light weight and flexible

Packaging:

- Hoses supplied in 250 ft. reels. All reels will have no more than 2 pieces, with no piece less than 50' in length.
- All non-standard lengths are treated as a made-to-order item and will require a minimum of 5,000 ft. to manufacture.

Temperature Range: -40°F (-40°C) to +200°F (+93°C) for petroleum based hydraulic fluids.

Nominal Specifications

Series Number	Size Code	Nominal ID		Nominal OD		Max. Working† Pressure (psi)	Min. Bend. Radius		Approx. Weight (lbs./ft.)	Coupling Recommendations
		(in.)	(mm)	(in.)	(mm)		Two-Piece Couplings			
							Ferrule Non-Skive			
PFAN388NC	04	1/4	6.4	0.496	12.6	3,000	1.50	38	0.06	PFR-04
PFAN388NC	06	3/8	9.7	0.650	16.5	3,000	2.00	51	0.11	PFR-06
PFAN388NC	08	1/2	13.1	0.834	21.2	3,000	3.00	76	0.16	PFR-08

† Minimum burst pressure 3-to-1 safety factor.

Freight: Hydraulic Hose can be combined with other KOA products for qualifying prepaid freight orders.

Because we continually examine ways to improve our products, we reserve the right to alter specifications or discontinue products without prior notice.

PFLT364 Series



Applications:

Piranhaflex™ PFLT364 Series hose is the ideal hose for medium pressure hydraulic lines commonly used on Fork Trucks to extend hose service life in cold storage applications.

Construction:

Piranhaflex™ PFLT364 Series hose consists of three individual components bonded to ensure maximum performance.

Tube – Seamless copolyester inner tube.

Reinforcement – Braided high tensile strength fiber reinforcement.

Cover – PFLT364 Series hose has a black copolyester pin pricked abrasion resistant cover.

Features:

- Meets or exceeds SAE J517 & J343 Standards
- Tested at ½ bend radius under SAE J517 100R7 Standards
- Exceeds SAE100R7 impulse requirements
- Light weight and flexible
- Improved cold temperature flexibility
- A special copolyester inner tube and cover provides superior low temperature flexibility

Packaging:

- Hoses supplied in 250 ft. reels. All reels will have no more than 2 pieces, with no piece less than 50' in length.
- All non-standard lengths are treated as a made-to-order item and will require a minimum of 5,000 ft. to manufacture.
- Twin/Multi Line MTO are available upon request.

Temperature Range: -65°F (-54°C) to +200°F (+93°C) for petroleum based hydraulic fluids.
-65°F (-54°C) to 140°F (+60°C) for water-based and phosphate-ester based hydraulic fluids.

Nominal Specifications

Series Number	Size Code	Nominal ID		Nominal OD		Max. Working Pressure (psi)	Min. Bend. Radius		Approx. Weight (lbs./ft.)	Coupling Recommendations
		(in.)	(mm)	(in.)	(mm)		(in.)	(mm)		Two-Piece Couplings
PFLT364	04	1/4	6.4	0.496	12.6	2,750	1.50	38	0.06	PFR-04
PFLT364	06	3/8	9.7	0.650	16.5	2,250	2.00	51	0.11	PFR-06
PFLT364	08	1/2	13.1	0.834	21.2	2,000	3.00	76	0.16	PFR-08

† Minimum burst pressure 4-to-1 safety factor.

Freight: Hydraulic Hose can be combined with other KOA products for qualifying prepaid freight orders.

Because we continually examine ways to improve our products, we reserve the right to alter specifications or discontinue products without prior notice.

PF628/PF628NC Series



Applications:

Piranhaflex™ PF628 Series hose is ideal for general purpose high pressure hydraulic applications with working pressures of 2,250 to 5,000 psi (depending on size). This hose is commonly used in industrial hydraulic construction, material handling, and agricultural equipment. Piranhaflex™ PF628NC Series hose has an orange, non pin-pricked cover ideal for use in applications where a non-conductive high pressure hydraulic hose is required. Typical applications include: hydraulic tools, lubrication lines and man lifts.

Construction:

Piranhaflex™ PF628 & PF628NC Series hoses consist of three individual components chemically bonded to ensure maximum performance.

Tube — Extruded seamless polyester inner tube.

Reinforcement — Aramid fiber reinforcement.

Cover — PF628 Series hose has a black highly abrasion resistant polyurethane pin picked cover; Series PF628NC hose has an Orange non-conductive (REACH Compliant), non-pin pricked abrasion resistant polyurethane cover.

Features:

- Extremely durable
- Good kink resistance
- Lightweight-less than about half that of comparable rubber/wire hose.
- Meets or exceeds SAE 100R8 impulse requirements at half of SAE recommended bend radius standards
- Will not swell or degrade in contact with most hydraulic fluids or oils
- Highly abrasion resistant
- Inner tube will not chip or peel in service, eliminating the possibility of system contamination.
- Linear change +/-3% under typical operating pressure.

Packaging:

- Hoses supplied in 250 ft. reels & 50 ft. box lengths. All reels will have no more than 2 pieces, with no piece less than 50' in length.
- All 50' boxes contain only 1 piece of hose.
- All non-standard lengths are treated as a made-to-order item and will require a minimum of 5,000 ft. to manufacture.
- For Twin Line please refer to page 14 for available stock sizes.

Temperature Range: -40°F (-40°C) to +200°F (+93°C) for petroleum based hydraulic fluids.
-40°F (-40°C) to +140° F (+60°C) for water-based and phosphate-ester based hydraulic fluids.

Nominal Specifications

Series Number	Size Code	Nominal ID		Nominal OD		Max. Working† Pressure (psi)	Min. Bend. Radius		Approx. Weight (lbs./ft.)	Coupling Recommendations
		(in.)	(mm)	(in.)	(mm)		(in.)	(mm)		Two-Piece Couplings
PF628/PF628NC	04	1/4	6.5	0.485	12.3	5,000	2.00	50	0.07	PFR-04
PF628/PF628NC	06	3/8	9.7	0.630	16.0	4,000	2.50	64	0.10	PFR-06
PF628/PF628NC	08	1/2	12.9	0.820	20.8	3,500	3.50	89	0.17	PFR-08
PF628/PF628NC	12	3/4	19.1	1.050	26.7	2,250	4.50	114	0.20	PFR-12

† Minimum burst pressure 4-to-1 safety factor.

Freight: Hydraulic Hose can be combined with other KOA products for qualifying prepaid freight orders.

Because we continually examine ways to improve our products, we reserve the right to alter specifications or discontinue products without prior notice.

PF427/PF427NC Series



Abrasion Resistant Polyurethane Cover

Braided High Tensile Strength Fiber Reinforcement

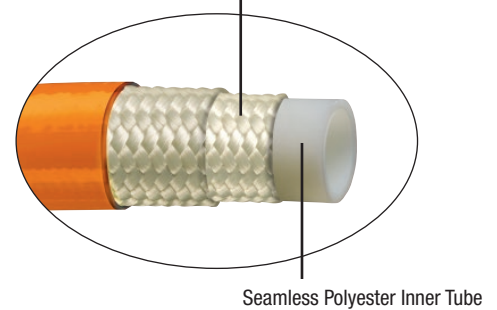

Seamless Polyester Inner Tube

Applications:

Piranhaflex™ PF427 Series hose is ideal for general purpose high pressure hydraulic applications with a constant working pressure of 3,000 psi for each diameter. This hose is commonly used in industrial hydraulic construction, material handling and agricultural equipment. Piranhaflex™ PF427NC Series hose has an orange, non-pin pricked cover, ideal for use in applications where a non conductive, high pressure hydraulic hose is required. Typical applications include: hydraulic tools, lubrication lines and man lifts.

Construction:

Piranhaflex™ Hydraulic PF427 & PF427NC Series hoses consist of three individual components bonded to ensure maximum performance.

Tube — Seamless polyester inner tube.

Reinforcement — Braided high tensile strength fiber reinforcement.

Cover — PF427 Series hose has a black abrasion resistant polyurethane pin pricked cover; PF427NC Series hose has an Orange non-conductive (REACH Compliant), non-pin pricked abrasion resistant polyurethane cover.

Temperature Range: -40°F (-40°C) to +200°F (+93°C) for petroleum based hydraulic fluids.
-40°F (-40°C) to +140°F (+60°C) for water-based and phosphate-ester based hydraulic fluids.

Features:

- Meets or exceeds SAE J517 Standards
- Tested at ½ bend radius under SAE Standards
- Exceeds 100R18 impulse requirements
- Light weight and flexible
- Ideal for general hydraulic services

Packaging:

- Hoses supplied in 250 ft. reels. All reels will have no more than 2 pieces, with no piece less than 50' in length.
- All non-standard lengths are treated as a made-to-order item and will require a minimum of 5,000 ft. to manufacture.
- Twin/Multi Line MTO and available upon request.

Nominal Specifications

Series Number	Size Code	Nominal ID		Nominal OD		Max. Working† Pressure (psi)	Min. Bend. Radius		Approx. Weight (lbs./ft.)	Coupling Recommendations	
		(in.)	(mm)	(in.)	(mm)		(in.)	(mm)		Two-Piece Couplings	
		Ferrule Non-Skive									
PF427/PF427NC	04	1/4	6.4	0.496	12.7	3,000	1.50	38	0.06	PFR-04	
PF427/PF427NC	06	3/8	9.7	0.650	16.5	3,000	2.00	51	0.11	PFR-06	
PF427/PF427NC	08	1/2	13.1	0.834	21.1	3,000	3.00	76	0.16	PFR-08	

† Minimum burst pressure 4-to-1 safety factor.

Freight: Hydraulic Hose can be combined with other KOA products for qualifying prepaid freight orders.

Because we continually examine ways to improve our products, we reserve the right to alter specifications or discontinue products without prior notice.

Thermoplastic Hydraulic Twin Line Versions



PF354TL & PF354NCTL Series Twin Line Versions:

**PIRANHAFLEX™ PF354TL Series Nylon Tube/
Black Cover 100R7 Twin Line Hoses**

Part Number	Packaging	Approx. Wt. lbs./ft.
PF354TL-04-250R	250' Reel	0.10
PF354TL-06-250R	250' Reel	0.20
PF354TL-08-250R	250' Reel	0.32

**PIRANHAFLEX™ PF354NCTL Series Nylon Tube/
Orange Cover Non-Conductive 100R7 Twin Line Hoses**

Part Number	Packaging	Approx. Wt. lbs./ft.
PF354NCTL-04-250R	250' Reel	0.10
PF354NCTL-06-250R	250' Reel	0.20
PF354NCTL-08-250R	250' Reel	0.32

PF267TL & PF267NCTL Series Twin Line Versions:

NEW

**PIRANHAFLEX™ PF267TL Series Nylon Tube/
Black Cover 100R7 Twin Line Hoses**

Part Number	Packaging	Approx. Wt. lbs./ft.
PF267TL-04-50BX	50 Box	0.14
PF267TL-06-50BX	50 Box	0.24
PF267TL-08-50BX	50 Box	0.34

**PIRANHAFLEX™ PF267NCTL Series Nylon
Tube/Orange Cover 100R7 Twin Line Hoses**

Part Number	Packaging	Approx. Wt. lbs./ft.
PF267NCTL-04-50BX	50 Box	0.14
PF267NCTL-06-50BX	50 Box	0.24
PF267NCTL-08-50BX	50 Box	0.34

NEW

Part Number	Packaging	Approx. Wt. lbs./ft.
PF267TL-04-250R	250' Reel	0.14
PF267TL-06-250R	250' Reel	0.24
PF267TL-08-250R	250' Reel	0.34

Part Number	Packaging	Approx. Wt. lbs./ft.
PF267NCTL-04-250R	250' Reel	0.14
PF267NCTL-06-250R	250' Reel	0.24
PF267NCTL-08-250R	250' Reel	0.34

Series PF628TL & PF628NCTL Twin Line Versions:

**PIRANHAFLEX™ PF628TL Series Polyester
Tube/Black Cover 100R8 Twin Line Hoses**

Part Number	Packaging	Approx. Wt. lbs./ft.
PF628TL-04-250R	250' Reel	0.14
PF628TL-06-250R	250' Reel	0.20
PF628TL-08-250R	250' Reel	0.34

**PIRANHAFLEX™ PF628NCTL Series Polyester Tube/
Orange Cover Non-Conductive 100R8 Twin Line Hoses**

Part Number	Packaging	Approx. Wt. lbs./ft.
PF628NCTL-04-250R	250' Reel	0.14
PF628NCTL-06-250R	250' Reel	0.20
PF628NCTL-08-250R	250' Reel	0.34

Freight: Hydraulic Hose can be combined with other KOA products for qualifying prepaid freight orders.

Because we continually examine ways to improve our products, we reserve the right to alter specifications or discontinue products without prior notice.

Piranha Bonding Capabilities

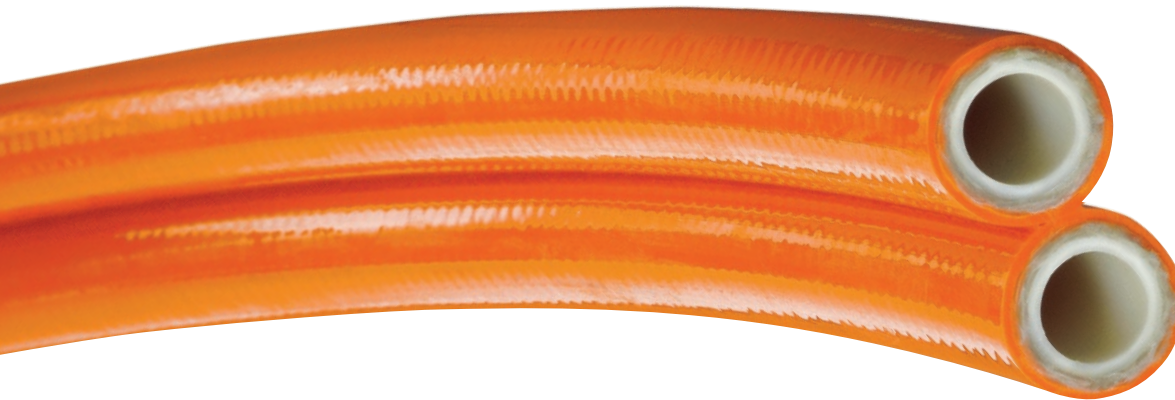

- Bonding of hose sizes from ¼” through 2” ID from available stocked hoses.
- For non-stock hose items, a minimum order of 2,500 ft. is required.
- Split-Back ends are provided; typically as lengths of 12”, 18” or 24” for ease of coupling and assembly.
- Intermittent bonding can also be provided in lengths to meet your applications needs.
- Special packaging is available as required to meet your application needs.



- Color coding of multi-line hose packs is available for identification and easy hook-ups.



- Combinations of same or different ID’s can be provided in a ribbon type configuration.



Custom Twin and Multi Line hoses are available upon request and are made to order.
For more information contact Piranha Hose Products, Inc.
Phone: (231) 779-4390 • Toll-free: (800) 250-5132 • International FAX: (231) 779-4399
Web Site: www.piranhahose.com • E-Mail: sales@piranhahose.com

Because we continually examine ways to improve our products, we reserve the right to alter specifications or discontinue products without prior notice.

PF321TC Series

Tank Charge – Compressor to tank fill hose

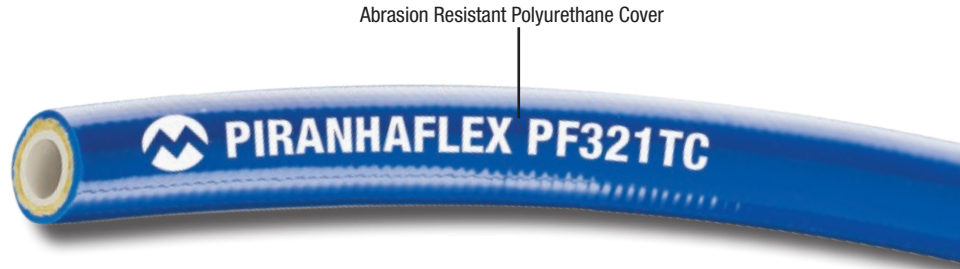
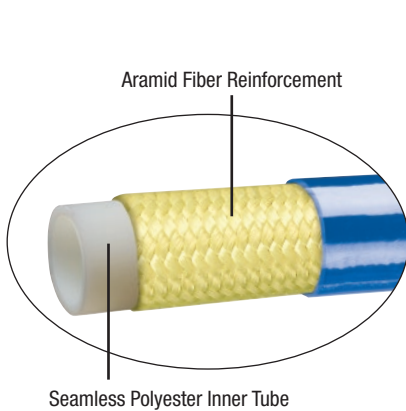

NEW



Applications:

Piranhaflex™ PF321TC Series hose for use with compressed breathing air.

NOTE:

- This hose is intended for stationary applications as a fill hose for breathing air tanks.
- “NOT” for use with explosive gasses such as pure oxygen and hydrogen.
- “NOT” for use between regulator and breathing mask.

Construction:

Piranhaflex™ PF321TC Series hoses consist of three individual components bonded to ensure maximum performance.

Tube – Seamless co-polyester inner tube.

Reinforcement – Aramid fiber reinforcement.

Cover – Blue abrasion resistant (Reach Compliant) polyurethane cover.

Features:

- Specially compounded tube minimizes extraction of particulates while in service.
- Pin-pricked jacket
- Hose complies with CGA Grade E Breathing Air Standards. Overall air quality depends on all system components
- Blue colored cover for ease of identification. Other colors available as an MTO (made-to-order)

Packaging:

- Hoses supplied in 250 ft. reels. All reels will have no more than 2 pieces, with no piece less than 50’ in length.
- All non-standard lengths are treated as a made-to-order item and will require a minimum of 5,000 ft. to manufacture.

Temperature Range: -40°F (-40°C) to +150° F (+65.5°C).

Nominal Specifications

Series Number	Size Code	Nominal ID		Nominal OD		Max. Working Pressure (psl)	Min. Bend. Radius		Approx. Weight (lbs./ft.)	Coupling Recommendations
		(in.)	(mm)	(in.)	(mm)		(in.)	(mm)		Two-Piece Couplings
PF321TC	03	3/16	4.8	0.400	10.2	6,000	1.50	38.1	0.06	PFR-03
PF321TC	04	1/4	6.4	0.485	12.3	6,000	2.00	50.8	0.07	PFR-04

Freight: Hydraulic Hose can be combined with other KOA products for qualifying prepaid freight orders.

Because we continually examine ways to improve our products, we reserve the right to alter specifications or discontinue products without prior notice.

NEW

PF344LMT Series Low Moisture Transmission Hose

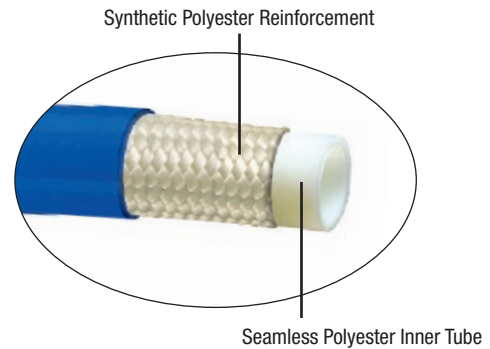

Applications:

Piranhaflex™ PF344LMT Series hose used in low moisture transmission applications. This hose is intended for use in common industrial applications such as conveying urethane foam components, deionized water transfer, distilled water transfer and pure water transfer.

Construction:

Piranhaflex™ PF344LMT Series hoses consist of three individual components bonded to ensure maximum performance.

Tube – Seamless specialty grade polyolefin.

Reinforcement – Synthetic polyester.

Cover – Blue abrasion resistant (Reach Compliant) polyurethane cover.

Features:

- Specially compounded tube to minimize the extraction of particulates and minimize moisture transmission.
- The cover is of specialty formulated smooth, seamless, perforated, polyurethane compound.

Packaging:

- Hoses supplied in 250 ft. reels. All reels will have no more than 2 pieces, with no piece less than 50' in length.
- All non-standard lengths are treated as a made-to-order item and will require a minimum of 5,000 ft. to manufacture.

Temperature Range: -40°F (-40°C) to +160° F (+71.1°C).

Nominal Specifications

Series Number	Size Code	Nominal ID		Nominal OD		Max. Working† Pressure (psl)	Min. Bend. Radius		Approx. Weight (lbs./ft.)	Coupling Recommendations	
		(in.)	(mm)	(in.)	(mm)		(in.)	(mm)		Two-Piece Couplings	Ferrule Non-Skive
		PF344LMT	04	1/4	6.4		.500	12.7		2,750	2.5
PF344LMT	06	3/8	9.7	.650	16.5	2,250	3.0	76.2	0.11	PFR-06	
PF344LMT	08	1/2	13.1	.830	21.1	2,000	4.0	101.6	0.16	PFR-08	
PF344LMT	12	3/4	19.1	1.18	30.0	1,500	5.0	127.0	0.28	AFX-12	
PF344LMT	16	1	25.4	1.46	37.1	1,500	6.0	152.4	0.40	AFX-16	

Freight: Hydraulic Hose can be combined with other KOA products for qualifying prepaid freight orders.

Because we continually examine ways to improve our products, we reserve the right to alter specifications or discontinue products without prior notice.

PFR3

NEW

Part Number	Dash Size	Hose ID Size		B OD (mm)	L Length (mm)	Weight Each (lbs.)
		(in.)	(mm)			
PFR3-04	-04	1/4	6.4	14.75	28.9	0.03
PFR3-05	05	5/16	7.9	17.4	28.8	0.04
PFR3-06	-06	3/8	9.5	19	28.8	0.04
PFR4-08	-08	1/2	12.7	23.7	36.3	0.06

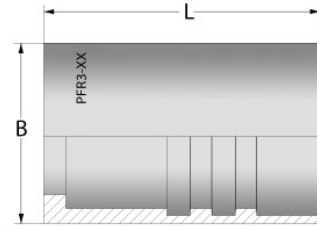

AFX

NEW

Part Number	Dash Size	Hose ID Size		B OD (mm)	L Length (mm)	Weight Each (lbs.)
		(in.)	(mm)			
AFX-03	03	3/16	4.8	21	21.5	0.05
AFX-04	04	1/4	6.4	23	24.7	0.07
AFX-05	05	5/16	7.9	25	24.7	0.08
AFX-06	06	3/8	9.5	27	29.7	0.10
AFX-08	08	1/2	12.7	30	30.5	0.11
AFX-10	10	5/8	15.9	34	35.5	0.15
AFX-12	12	3/4	19.0	38	36.0	0.17
AFX-16	16	1	25.4	48	42.5	0.28

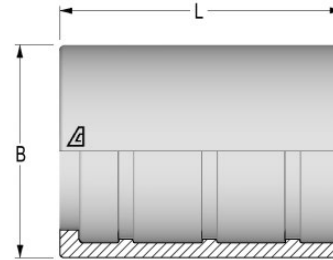

Universal Ferrules

For SAE 100R7, 100R8, 100R18 & ANSI 92.2 Hoses (Steel)

PFR/PFR7

Part Number	Dash Size	Hose ID Size		B OD (mm)	L Length (mm)	Weight Each (lbs.)
		(in.)	(mm)			
PFR-03	03	3/16	4.7	14.9	24.0	0.03
PFR-04	04	1/4	6.4	17.0	29.0	0.04
PFR7-05*	05	5/16	7.9	19.0	29.0	0.04
PFR-06	06	3/8	9.5	21.0	31.0	0.05
PFR-08	08	1/2	12.7	25.4	36.0	0.06
PFR-12	12	3/4	19.05	31.8	45.2	0.11

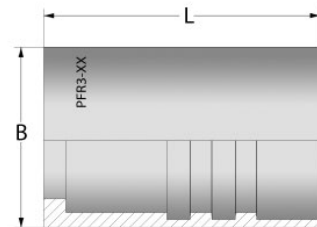

* PFR7-05 ferrules are to be used only with SAE 100R7 hoses!

Kuriyama stocks a variety of fittings designed for use with all of our Piranhaflex™ SAE 100R7, 100R8, 100R18 and ANSI 92.2 hoses. For more information contact your nearest Kuriyama warehouse location. Please refer to our latest Kuriyama Hydraulic Connections Catalog for a complete list of available two-piece fittings.

Because we continually examine ways to improve our products, we reserve the right to alter specifications or discontinue products without prior notice.

Inserts for two-piece fittings – US End Configurations

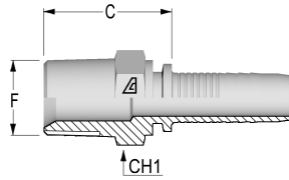

NPTF Solid Male 60° Seat

Part Number	Dash Size	Hose ID Size		F Thread		C Cut-Off Factor (mm)	Hex Dia. CH1 (mm)	Weight Each (lbs.)
		(in.)	(mm)	Dash Size	Size (in. TPI)			
A-0302-MNPT	03	3/16	4.8	02	1/8-27	19.8	12	0.03
A-0402-MNPT	04	1/4	6.4	02	1/8-27	21.3	14	0.04
A-0404-MNPT	04	1/4	6.4	04	1/4-18	26.8	17	0.06
A-0406-MNPT	04	1/4	6.4	06	3/8-18	27.8	19	0.08
A-0504-MNPT	05	5/16	7.9	04	1/4-18	26.8	17	0.07
A-0506-MNPT	05	5/16	7.9	06	3/8-18	27.8	19	0.11
A-0604-MNPT	06	3/8	9.5	04	1/4-18	26.8	17	0.07
A-0606-MNPT	06	3/8	9.5	06	3/8-18	27.8	19	0.09
A-0608-MNPT	06	3/8	9.5	08	1/2-14	31.3	22	0.15
A-0806-MNPT	08	1/2	12.7	06	3/8-18	28.6	19	0.12
A-0808-MNPT	08	1/2	12.7	08	1/2-14	32.1	22	0.17
A-0812-MNPT	08	1/2	12.7	12	3/4-14	34.1	27	0.22
A-1012-MNPT	10	5/8	15.9	12	3/4-14	34.1	27	0.24
A-1212-MNPT	12	3/4	19.0	12	1-11 1/2	34.6	27	0.26

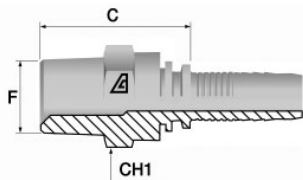

NPTF Male Swivel 60° Seat

Part Number	Dash Size	Hose ID Size		F Thread		C Cut-Off Factor (mm)	Hex Dia. CH1 (mm)	Weight Each (lbs.)
		(in.)	(mm)	Dash Size	Size (in. TPI)			
A-0404-MNPS	04	1/4	6.4	04	1/4-18	37.6	17	0.09
A-0604-MNPS	06	3/8	9.5	04	1/4-18	39.6	17	0.12
A-0606-MNPS	06	3/8	9.5	06	3/8-18	37.5	22	0.15
A-0806-MNPS	08	1/2	12.7	06	3/8-18	38.3	22	0.17
A-0808-MNPS	08	1/2	12.7	08	1/2-14	42.3	25	0.25
A-1212-MNPS	12	3/4	19.0	12	3/4-14	50.1	32	0.31

Because we continually examine ways to improve our products, we reserve the right to alter specifications or discontinue products without prior notice.

Inserts for two-piece fittings – US End Configurations

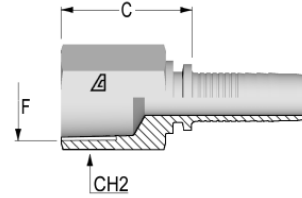

NPTF Solid Female Rigid

Part Number	Dash Size	Hose ID Size		F Thread		C Cut-Off Factor (mm)	Hex Dia. CH2 (mm)	Weight Each (lbs.)
		(in.)	(mm)	Dash Size	Size (in. TPI)			
A-0404-FNPR	04	1/4	6.4	04	1/4-18	27.8	19	0.10
A-0606-FNPR	06	3/8	9.5	06	3/8-18	28.8	22	0.17
A-0808-FNPR	08	1/2	12.7	08	1/2-14	35.6	25	0.20
A-1212-FNPR	12	3/4	19.0	12	3/4-14	38.1	32	0.35

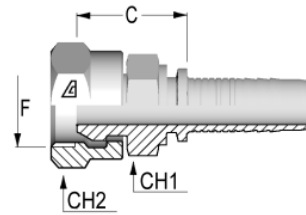

NPSM Female Swivel 60° Seat

Part Number	Dash Size	Hose ID Size		F Thread		C Cut-Off Factor (mm)	Hex Dia. CH1 (mm)	Hex Dia. CH2 (mm)	Weight Each (lbs.)
		(in.)	(mm)	Dash Size	Size (in. TPI)				
A-0404-FPMS	04	1/4	6.4	04	1/4-18	24.3	17	19	0.09
A-0606-FPMS	06	3/8	9.5	06	3/8-18	24.8	19	22	0.14
A-0808-FPMS	08	1/2	12.7	08	1/2-14	26.6	22	27	0.22

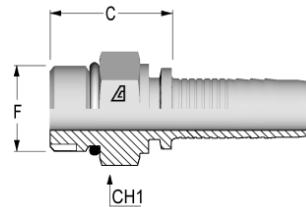

SAE Solid Male O-Ring Boss

Part Number	Dash Size	Hose ID Size		F Thread		C Cut-Off Factor (mm)	Hex Dia. CH1 (mm)	Weight Each (lbs.)
		(in.)	(mm)	Dash Size	Size (in. TPI)			
A-0404-MORB	04	1/4	6.4	04	7/16-20	20.3	14	0.04
A-0405-MORB	04	1/4	6.4	05	1/2-20	21.3	16	0.05
A-0406-MORB	04	1/4	6.4	06	9/16-18	22.3	17	0.06
A-0606-MORB	06	3/8	9.5	06	9/16-18	23.3	19	0.08
A-0608-MORB	06	3/8	9.5	08	3/4-16	24.3	22	0.12
A-0610-MORB	06	3/8	9.5	10	7/8-14	26.8	27	0.16
A-0808-MORB	08	1/2	12.7	08	3/4-16	25.1	22	0.14
A-0810-MORB	08	1/2	12.7	10	7/8-14	27.6	27	0.19
A-0812-MORB	08	1/2	12.7	12	1 1/16-12	32.1	32	0.28
A-1210-MORB	12	3/4	19.0	10	7/8-14	28.1	27	0.24
A-1212-MORB	12	3/4	19.0	12	1 1/16-12	32.6	32	0.31
A-1216-MORB	12	3/4	19.0	16	1 5/16-12	35.7	38	0.44

Because we continually examine ways to improve our products, we reserve the right to alter specifications or discontinue products without prior notice.

Inserts for two-piece fittings – US End Configurations

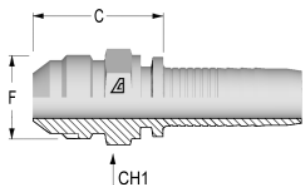

JIC Solid Male 37° Seat

Part Number	Dash Size	Hose ID Size		F Thread		C Cut-Off Factor (mm)	Hex Dia. CH1 (mm)	Weight Each (lbs.)
		(in.)	(mm)	Dash Size	Size (in. TPI)			
A-0404-MJIC	04	1/4	6.4	04	7/16-20	25.3	12	0.04
A-0405-MJIC	04	1/4	6.4	05	1/2-20	25.3	14	0.05
A-0406-MJIC	04	1/4	6.4	06	9/16-18	26.3	17	0.06
A-0505-MJIC	05	5/16	7.9	05	1/2-20	25.3	14	0.05
A-0506-MJIC	05	5/16	7.9	06	9/16-18	26.3	17	0.07
A-0606-MJIC	06	3/8	9.5	06	9/16-18	26.3	17	0.07
A-0608-MJIC	06	3/8	9.5	08	3/4-16	29.8	19	0.11
A-0808-MJIC	08	1/2	12.7	08	3/4-16	29.8	19	0.12
A-0810-MJIC	08	1/2	12.7	10	7/8-14	34.6	24	0.19
A-0812-MJIC	08	1/2	12.7	12	1 1/16-12	37.1	27	0.23
A-1212-MJIC	12	3/4	19.0	12	1 1/16-12	37.6	27	0.27
A-1214-MJIC	12	3/4	19.0	14	1 3/16-12	40.1	32	0.36
A-1216-MJIC	12	3/4	19.0	16	1 5/16-12	42.6	36	0.54

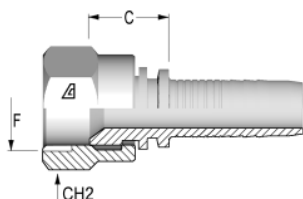

JIC Female 37° Seat

Part Number	Dash Size	Hose ID Size		F Thread		C Cut-Off Factor (mm)	Hex Dia. CH2 (mm)	Weight Each (lbs.)
		(in.)	(mm)	Dash Size	Size (in. TPI)			
A-0304-FJSH	03	3/16	4.8	04	7/16-20	14.3	16	0.04
A-0404-FJSH	04	1/4	6.4	04	7/16-20	14.6	16	0.04
A-0405-FJSH	04	1/4	6.4	05	1/2-20	15.3	17	0.06
A-0406-FJSH	04	1/4	6.4	06	9/16-18	15.3	19	0.07
A-0505-FJSH	05	5/16	7.9	05	1/2-20	15.3	17	0.07
A-0506-FJSH	05	5/16	7.9	06	9/16-18	15.3	19	0.08
A-0606-FJSH	06	3/8	9.5	06	9/16-18	15.3	19	0.08
A-0608-FJSH	06	3/8	9.5	08	3/4-16	17.8	25	0.14
A-0808-FJSH	08	1/2	12.7	08	3/4-16	18.6	25	0.16
A-0810-FJSH	08	1/2	12.7	10	7/8-14	19.6	27	0.19
A-0812-FJSH	08	1/2	12.7	12	1 1/16-12	22.1	32	0.25
A-1210-FJSH	12	3/4	19.0	10	7/8-14	20.0	27	0.28
A-1212-FJSH	12	3/4	19.0	12	1 1/16-12	20.0	32	0.28
A-1214-FJSH	12	3/4	19.0	14	1 3/16-12	20.0	36	0.33
A-1216-FJSH	12	3/4	19.0	16	1 5/16-12	22.1	38	0.38

Because we continually examine ways to improve our products, we reserve the right to alter specifications or discontinue products without prior notice.

Inserts for two-piece fittings – US End Configurations

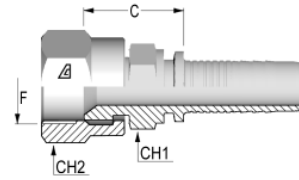

JIC Female 37° Seat – Double Hex

Part Number	Dash Size	Hose ID Size		F Thread		C Cut-Off Factor (mm)	Hex Dia. CH1 (mm)	Hex Dia. CH2 (mm)	Weight Each (lbs.)
		(in.)	(mm)	Dash Size	Size (in. TPI)				
A-0404-FJDH	04	1/4	6.4	04	7/16-20	19.6	14	16	0.06
A-0405-FJDH	04	1/4	6.4	05	1/2-20	20.3	14	17	0.07
A-0406-FJDH	04	1/4	6.4	06	9/16-18	20.3	14	19	0.09
A-0506-FJDH	05	5/16	7.9	06	9/16-18	20.3	14	19	0.08
A-0606-FJDH	06	3/8	9.5	06	9/16-18	21.3	17	19	0.10
A-0608-FJDH	06	3/8	9.5	08	3/4-16	24.8	19	25	0.17
A-0610-FJDH	06	3/8	9.5	10	7/8-14	25.8	22	22	0.20
A-0806-FJDH	08	1/2	12.7	06	9/16-18	23.1	19	19	0.15
A-0808-FJDH	08	1/2	12.7	08	3/4-16	25.6	19	25	0.20
A-0810-FJDH	08	1/2	12.7	10	7/8-14	26.6	22	27	0.22
A-0812-FJDH	08	1/2	12.7	12	1 1/16-12	28.1	25	32	0.30
A-1210-FJDH	12	3/4	19.0	10	7/8-14	28.1	27	32	0.31
A-1212-FJDH	12	3/4	19.0	12	1 1/16-12	28.6	27	32	0.35
A-1214-FJDH	12	3/4	19.0	14	1 3/16-12	29.9	32	36	0.44
A-1216-FJDH	12	3/4	19.0	16	1 5/16-12	32.1	32	38	0.49

JIS Female Swivel 30° Seat – B 8363 Type F

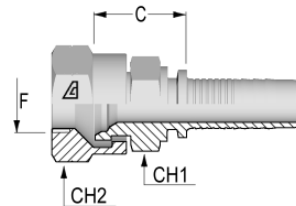

Part Number	Dash Size	Hose ID Size		F Thread		C Cut-Off Factor (mm)	Hex Dia. CH1 (mm)	Hex Dia. CH2 (mm)	Weight Each (lbs.)
		(in.)	(mm)	Dash Size	Size (in. TPI)				
A-0404-FJIS	04	1/4	6.4	04	1/4-19	20.8	17	19	0.09
A-0606-FJIS	06	3/8	9.5	06	3/8-19	21.8	19	22	0.13
A-0808-FJIS	08	1/2	12.7	08	1/2-14	23.6	22	27	0.20
A-1212-FJIS	12	3/4	19.0	12	3/4-14	27.1	30	36	0.41

Because we continually examine ways to improve our products, we reserve the right to alter specifications or discontinue products without prior notice.

For use with PF321TC Series hose only

NEW

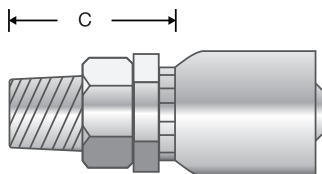

NPTF Solid Male 60° Seat

Part Number	Dash Size	Hose ID Size		F Thread		C Cut-Off Factor (mm)	Hex Dia. CH1 (mm)	Weight Each (lbs.)
		(in.)	(mm)	Dash Size	Size (in. TPI)			
P-0302-MNPT-SS	03	3/16	4.8	02	1/8-27	26.6	17	0.100
P-0304-MNPT-SS	03	3/16	4.8	04	1/4-18	28.6	19	0.107
P-0404-MNPT-SS	04	1/4	6.4	04	1/4-18	28.6	22	0.117

For use with PF321TC Series hose only

NEW

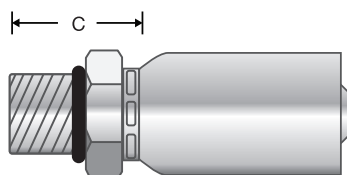

SAE Solid Male O-Ring Boss

Part Number	Dash Size	Hose ID Size		F Thread		C Cut-Off Factor (mm)	Hex Dia. CH1 (mm)	Weight Each (lbs.)
		(in.)	(mm)	Dash Size	Size (in. TPI)			
P-0304-MORB-SS	03	3/16	4.8	04	7/16-20	22.2	17	0.105
P-0404-MORB-SS	04	1/4	6.4	04	7/16-20	22.2	19	0.115

For use with PF321TC Series hose only

NEW

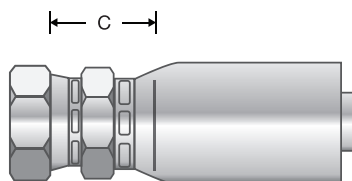

JIC Female 37° Seat

Part Number	Dash Size	Hose ID Size		F Thread		C Cut-Off Factor (mm)	Hex Dia. CH1 (mm)	Weight Each (lbs.)
		(in.)	(mm)	Dash Size	Size (in. TPI)			
P-0304-FJDH-SS	03	3/16	4.8	04	7/16-20	19.1	17	0.113
P-0404-FJDH-SS	04	1/4	6.4	04	7/16-20	19.1	19	0.123

Because we continually examine ways to improve our products, we reserve the right to alter specifications or discontinue products without prior notice.

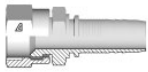

A-XXXX-FSAE

SAE Female 45° Seat – Double Hex

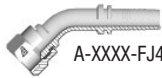

A-XXXX-FJ45

Other Configurations Available

A-XXXX-FJ9 (S,M,L)

45° & 90° JIC Female Swivel 37°
Seat Solid Bent Tube

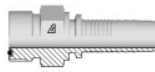

A-XXXX-MOFS

ORFS Solid Male

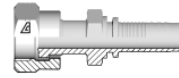

A-XXXX-FOFS

Other Configurations Available

A-XXXX-F045, A-XXXX-F09 (S,M,L)

Straight, 45° & 90°
ORFS Female

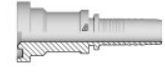

A-XXXX-C61S

Other Configurations Available

A-XXXX-C612, A-XXXX-C613, A-XXXX-C614, A-XXXX-C616, A-XXXX-C619

Straight, 22°, 30°, 45°, 60° & 90°
O-Ring Flange SAE J518 Code
61, 62

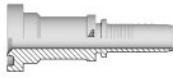

A-XXXX-C62S

Other Configurations Available

A-XXXX-C624, A-XXXX-C629

Straight, 45° & 90° O-Ring
Flange SAE J518 Code 62 Solid
One Piece



C61SF-XX, C62SF-XX

Split Flange Clamps SAE J518
Code 61 & 62



A-XXXX-HMEN



A-XXXX-FGRT



A-XXXX-BTTF

Hose Mender, Grease Fitting &
Bite Type Tube Fitting



A-XXXX-MBPP



A-XXXX-MBFS



A-XXXX-MBPT

BSP/JIS Solid Male



A-XXXX-BBAN

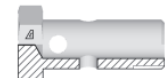

BBOLT-XX

BSP Banjo, BSPP Bolt

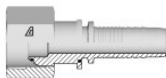

A-XXXX-FBPO

Other Configurations Available

A-XXXX-FB04, A-XXXX-FB09

Straight, 45° & 90° BSP O-Ring
Female Swivel 60° Cone

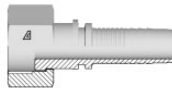

A-XXXX-FBFS

BSP Female Swivel Flat Seat

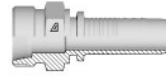

A-XXXX-MMSL

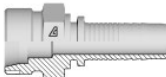

A-XXXX-MMSH

Metric Solid Male 24° Seat – DIN
3853 Light & Heavy



A-XXXX-MBAN

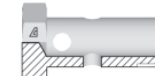

MBOLT-XX

Metric Banjo, Metric Bolt

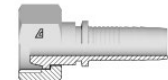

A-XXXX-FMOL

Other Configurations Available

A-XXXX-FM4L, A-XXXX-FM9L

Straight, 45° and 90°
Metric O-Ring Female Swivel 24°
Seat – DIN 3865 Light

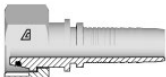

A-XXXX-FMOH

Other Configurations Available

A-XXXX-FM4H, A-XXXX-FM9H

Straight, 45° and 90°
Metric O-Ring Female Swivel 24°
Seat – DIN 3865 Heavy



A-XXXX-MSPS

Other Configurations Available

A-XXXX-MSP4, A-XXXX-MSP9

Straight, 45° & 90° Metric
Standpipe



MTN-XXLXXXX, MTN-XXHXXXX

Nut DIN 24° Light and Heavy



MBS-XXL, MBS-XXH
Double Cutting Ring DIN 24°
Light & Heavy

A-XXXX-FMFS

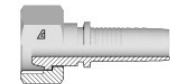

Metric Female French Type

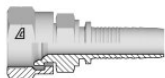

A-XXXX-FKOS

Other Configurations Available

A-XXXX-KFST, A-XXXX-KF45,
A-XXXX-KF90

Komatsu Female Swivel &
Straight, 45° & 90° Flanges

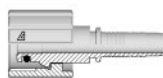

A-XXXX-FPWS

Pressure Wash Female (Type K)

Because we continually examine ways to improve our products, we reserve the right to alter specifications or discontinue products without prior notice.

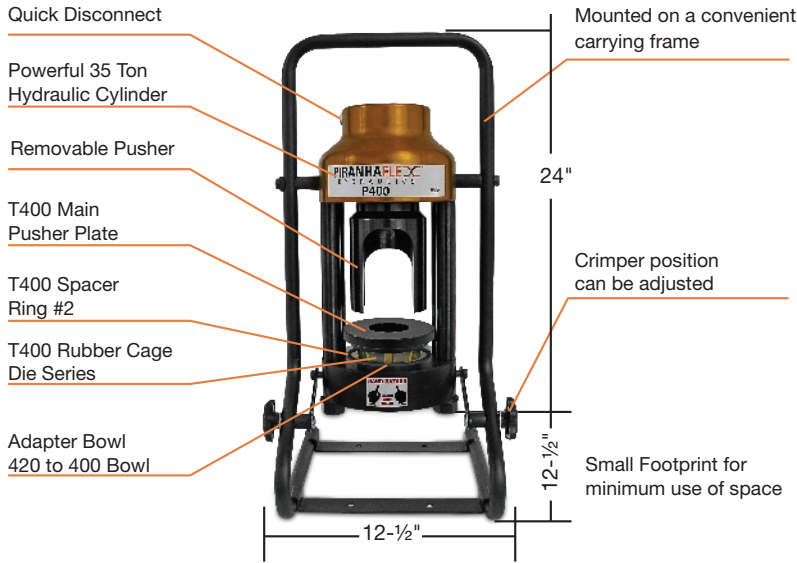

The P400 Portable hose press is light weight making it truly "portable" and can be carried to almost any location where service is required. It can be paired with either a Hand Pump, Pneumatic Pump or Electric Pump, make the perfect combination for shop or portable crimping requirements.

Technical Data
35 Ton
1" - 2 Wire
3/4" - 4SP
L: 12-1/2" x W: 12-1/2" x H: 24"
Weight: 47 lbs
Die Series: PF402 Rubber Caged

ENGINEERED TO ACCOMMODATE YOUR NEEDS

- 35 Tons of crimping force.
- Hose capacity up to 1" 2 wire and 3/4" 4SP.
- Available ValPower® Hand Pump, Pneumatic Pump 10,000 psi or Electric Pump.
- Removable Pusher and 2 piece PF402 rubber caged die set make accurate fitting positioning easy.
- PF402 rubber caged dies sets for heavy duty environments.
- Color-coded die rubber cages for easy identification.
- Base mounting holes allow the crimper to be bench or truck bed mounted if required.

DURABLE, RELIABLE DESIGN = PROFITABILITY

- Crimper position can be adjusted for optimum crimping position or dropped to vertical position for better balance when the crimper is being carried.
- Open design to provide excellent operator visibility.
- Complete range of dies and accessories available.

Pump Options & Accessories:



T420 Micrometer (Available)
P/N:103085



Hand Pump (Available)
P/N:VHP-10-43



Pneumatic Pump (Available)
P/N:VAP-10-100

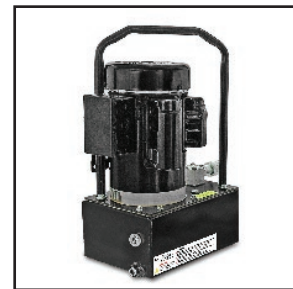

Electric Pump (Available)
P/N:VEP1001



Die Removal Magnet
(Included) P/N:104679



CRIMPX Die Lubricant: Oil 4 oz bottle with dauber cap
(Included) P/N:103886



CRIMPX Die Lubricant (Available)
Grease 4 oz can with brush
P/N:104162



Die Storage Shelf
(Available) P/N:101431

Because we continually examine ways to improve our products, we reserve the right to alter specifications or discontinue products without prior notice.



T400 12mm Die Set
P/N:PF402-12D

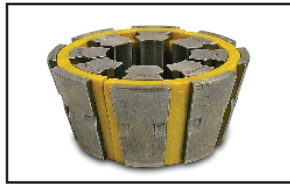

T400 14.2mm Die Set
P/N:PF402-14.2D



T400 17.4mm Die Set
P/N:PF402-17.4D

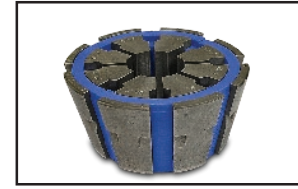

T400 22.2mm Die Set
P/N:PF402-22.2D



Adapter Bowl 420 to
400 Bowl
P/N:PF420/400-AB



T400 Main Pusher Plate
W/ Magnets
P/N:PF400-MPP



T400 Spacer Ring #1
P/N:PF402-1-SR



T400 Spacer Ring #2
P/N:PF402-2-SR



Light Weight Portable Unit:
Truly "portable" crimping can be carried to almost any location where services is required.



ENGINEERED TO ACCOMMODATE YOUR NEEDS

- 2 piece PF402 rubber caged die set make accurate fitting positioning easy.
- PF402 rubber caged dies sets for heavy duty environments.
- Color-coded die rubber cages for easy identification.



Because we continually examine ways to improve our products, we reserve the right to alter specifications or discontinue products without prior notice.



**Part No. – HCMD
Medium Cutter**

- Medium Hose and Tubing Cutter
- Cuts up to 1 5/8" Hose and Tubing
- Weight 4.3 oz.



**Part No. – HCMD-BLADE
Replacement blade for Medium Cutter**

Medium Hose and Tubing Cutter



**Part No. – HCLG
Large Cutter**

- Large Hose - Tubing Cutter
- Cuts up to 1 7/8" OD Hose and Tubing
- Weight 5.0 oz



**Part No. – HCLG-BLADE
Replacement blade for Large Cutter**

Large Bundle - Hose - Tubing Cutter



**Part No. – HCRCT
One Handed Ratchet Hose Cutter**

- Cuts up to 2 1/2" OD Hoses
- Weight 1.4 lbs



**Part No. – HCRCT-BLADE
Replacement blade for One Handed Ratchet Cutter**

Large Bundle - Hose - Tubing Cutter

Because we continually examine ways to improve our products, we reserve the right to alter specifications or discontinue products without prior notice.

Cautionary Statement

All Products sold and distributed by Kuriyama of America, Inc. are in the nature of commodities and they are sold by published specifications and not for particular purposes, uses or applications. Purchaser shall first determine their suitability for the intended purposes, uses or applications and shall either conduct its own engineering studies or tests, or retain qualified engineers, consultants or testing laboratories and consult with them before determining the proper use, suitability or propriety of the merchandise or Products for the intended purposes, uses or applications.

Kuriyama of America, Inc. ("Seller") does not recommend the Products for any particular purpose, use or application, and the Purchaser or user thereof shall assume full responsibility for the suitability, propriety, use and application of the Products. Purchaser shall follow all instructions contained in Seller's catalogs, brochures, technical bulletins and other documents regarding the Products. The Products, including but not limited to, hose, tubing or couplings, may fail due to the use or conveyance of substances at elevated or lowered temperatures or at excessive pressure, the conveyance of abrasive, injurious, flammable, explosive or damaging substances.

Hose or tubing used in bent configurations will be subjected to increased abrasion. Hose clamps or couplings may loosen after initial installation and all sections of hose and tubing including connections, couplings, clamps, conductivity and bonding should be inspected frequently, regularly and consistently, and should be replaced, adjusted or re-tightened for the avoidance of leakage, for the prevention of injuries or damages, and for general safety purposes. Except as indicated in its Limited Warranty, Seller shall not be liable or responsible for direct or indirect injuries or damages caused by or attributed to the failure or malfunction of any Products sold or distributed by it.

Purchasers or users of the Products should frequently and consistently undertake inspections and protective measures with respect to the use and application of Products, which should include the examination of tube and cover, conditions of the hose or tubing, and the identification, repair or replacement of sections showing cracking, blistering, separations, internal and external abrasions, leaking or slipped couplings or connections and make proper proof tests.

Limited Warranty

The Products sold or distributed by Seller are warranted to its customers to be free from defects in material and workmanship at the time of shipment by us, subject to the following provisions. ALL WARRANTY CLAIMS SHALL BE MADE WITHIN SIX (6) MONTHS AFTER SELLER SHIPPED THE PRODUCTS. SELLER'S LIABILITY HEREUNDER IS LIMITED AT SELLER'S EXCLUSIVE DISCRETION, TO 1) THE PURCHASE PRICE OF ANY PRODUCTS PROVING DEFECTIVE; 2) REPAIR OF ANY DEFECTIVE PRODUCT OR PART THEREOF; OR 3) REPLACEMENT OF ANY DEFECTIVE PRODUCT OR PART UPON ITS AUTHORIZED RETURN TO SELLER.

THIS WARRANTY IS IN LIEU OF AND EXCLUDES ALL OTHER WARRANTIES, EXPRESSED, IMPLIED, STATUTORY, OR OTHERWISE CREATED UNDER APPLICABLE LAW INCLUDING, BUT NOT LIMITED TO, THE WARRANTY OF MERCHANTABILITY AND THE WARRANTY OF FITNESS FOR A PARTICULAR PURPOSE. IN NO EVENT SHALL SELLER OR THE MANUFACTURER OF THE PRODUCT BE LIABLE FOR SPECIAL, INCIDENTAL, OR CONSEQUENTIAL DAMAGES, INCLUDING LOSS OF PROFITS, WHETHER OR NOT CAUSED BY OR RESULTING FROM THE NEGLIGENCE OF SELLER AND/OR THE MANUFACTURER OF THE PRODUCT, UNLESS SPECIFICALLY PROVIDED HEREIN. IN ADDITION, THIS WARRANTY SHALL NOT APPLY TO ANY PRODUCTS OR PORTIONS THEREOF WHICH HAVE BEEN SUBJECTED TO ABUSE, MISUSE, IMPROPER INSTALLATION, MAINTENANCE, OR OPERATION, ELECTRICAL FAILURE OR ABNORMAL CONDITIONS, AND TO PRODUCTS WHICH HAVE BEEN TAMPERED WITH, ALTERED, MODIFIED, REPAIRED, REWORKED BY ANYONE NOT APPROVED BY SELLER, OR USED IN ANY MANNER INCONSISTENT WITH THE PROVISIONS OF THE "CAUTIONARY STATEMENT" ABOVE OR ANY INSTRUCTIONS OR SPECIFICATIONS PROVIDED WITH OR FOR THE PRODUCT.

09/2005

Distributed by:



Kuriyama of America, Inc.

Headquarters, Sales Office and Warehouse Location

360 E. State Parkway, Schaumburg, IL 60173-5335
Phone: (847) 755-0360 • Toll-free FAX: (800) 800-0320

International FAX: (847) 885-0996

Web Site: www.kuriyama.com
E-Mail: sales@kuriyama.com



Visit us
www.kuriyama.com
on the Web!



Piranha Hose Products Inc. is ISO 9001 certified.

The trademarks contained in this publication are trademarks of Kuriyama of America, Inc.

CONTACT OUR SALES/WAREHOUSE LOCATIONS BELOW WHICH SERVE YOUR AREA

SOUTHWEST WAREHOUSE KURIYAMA OF AMERICA, INC. HOUSTON

200 PORTWALL STREET, SUITE 100
HOUSTON, TX 77029
Phone: (713) 674-8212
Toll Free Phone: (800) 501-6808
FAX: (713) 674-5214
Toll Free FAX: (800) 800-5214

WESTERN WAREHOUSE KURIYAMA OF AMERICA, INC. SANTA FE SPRINGS

10749 SHOEMAKER AVENUE
SANTA FE SPRINGS, CA 90670-4039
Phone: (562) 941-4507
FAX: (562) 941-8940
Toll-Free FAX: (800) 326-8940

SOUTHEAST WAREHOUSE FORTNEY SALES CO., INC. 4221 CANTRELL ROAD NW ACWORTH, GA 30101

Phone: (770) 427-6528
FAX: (770) 423-9249
Toll Free FAX: (800) 423-9249
Web Site: www.fortneysales.com
E-Mail: sales@fortneysales.com

EASTERN WAREHOUSE EASTERN RUBBER & PLASTICS CO., INC.

100 GOLDMAN DR.
PLUMSTED INDUSTRIAL PARK
CREAM RIDGE, NJ 08514
Phone: (609) 758-0100
FAX: (609) 758-0102
Toll Free FAX: (800) 445-7138
Web Site: www.easternrubber.com
E-Mail: sales@easternrubber.com

IN CANADA:

KURI TEC CORPORATION
140 ROY BOULEVARD
BRANTFORD, ONT, CANADA N3R 7K2
Phone: (519) 753-6717
FAX: (519) 753-7737
Web Site: www.kuritec.com
E-Mail: sales@kuritec.com

IN MEXICO:

KURIYAMA DE MÉXICO S DE RL DE CV
AV JOSE PALOMO MARTINEZ NO 520-20
BODEGA 5
PARQUE INDUSTRIAL OMOLAP
APODACA, N.L. CP:66633, MÉXICO
Telefonos: (81) 1086-1870 O 71
Lada sin Costo 01 800 822 52 00
FAX: (81) 1086-1869
Internet: www.kuriyama.com
Correo Electronico: ventas@kuriyama.com



kuriyama.com/50years