

TSR — Low Voltage Surface Raceway Accessories

HellermannTyton provides a complete line of fittings to manage connectivity requirements from the telecommunications room to the work area. Each size of raceway offers numerous fittings, offered in electrical ivory, white or office white, including TIA/EIA-568-B compliant 1" bend radius accessories which help ensure consistent data transmission performance of Category 5, 5e and 6 communications systems.



Designated with -50



Designated with -36



Designated with -25-1



Designated with -29-1



Designated with -14



Designated with -12



Designated with -33-1



Designated with -21-1



*Recommend using the TSRX-JB2 for voice and data applications

Product Selection

Part Number	Description	Pkg. Qty.
TSR1 Fittings		
TSR1X-14	Splice Cover – 3/4"	10
TSR1X-21-1	Tee Cover – 3/4" – 1" Bend Radius	10
TSR1X-25-1	Elbow Cover – 3/4" – 1" Bend Radius	10
TSR1X-29-1	External Corner – 3/4" – 1" Bend Radius	10
TSR1X-33-1	Internal Corner – 3/4" – 1" Bend Radius	10
TSR1X-36	End Cap – 3/4"	10
TSR1X-50	Ceiling Drop – 3/4"	10
TSR2 Fittings		
TSR2X-14	Splice Cover – 1-1/4"	10
TSR2X-21-1	Tee Cover – 1-1/4" – 1" Bend Radius	10
TSR2X-25-1	Elbow Cover – 1-1/4" – 1" Bend Radius	10
TSR2X-29-1	External Corner – 1-1/4" – 1" Bend Radius	10
TSR2X-33-1	Internal Corner – 1-1/4" – 1" Bend Radius	10
TSR2X-36	End Cap – 1-1/4"	10
TSR2X-50	Ceiling Drop – 1-1/4"	10
TSR3 Fittings		
TSR3X-14	Splice Cover – 1-3/4"	10
TSR3X-21-1	Tee Cover – 1-3/4" – 1" Bend Radius	10
TSR3X-25-1	Elbow Cover – 1-3/4" – 1" Bend Radius	10
TSR3X-29-1	External Corner – 1-3/4" – 1" Bend Radius	10
TSR3X-33-1	Internal Corner – 1-3/4" – 1" Bend Radius	10
TSR3X-36	End Cap – 1-3/4"	10
TSR3X-50	Ceiling Drop – 1-3/4"	10
Reducers		
TSR1X-12	Reducer – 1-3/4" to 1-1/4" (TSR3 to TSR2)	10
TSR2X-12	Reducer – 1-3/4" to 3/4" (TSR3 to TSR1)	10
TSR3X-12	Reducer – 1-1/4" to 3/4" (TSR2 to TSR1)	10
Junction Boxes		
TSRX-JB1	Junction Box Single Gang – 3"(W) x 4-3/4"(L) x 1-1/4"(H)	1
TSRX-JB2*	Junction Box Single Gang – 3"(W) x 4-3/4"(L) x 2"(H)	1
TSRX-JBD	Junction Box Dual Gang – 4.91"(W) x 4.83"(L) x 1-1/2"(H)	1

Replace "X" in the part number with the following letters for desired color:
 X = I (ivory), FW (office white), W (white)

Junction Boxes

Offered in a dual or single gang format, HellermannTyton's low voltage junction boxes are versatile enough for any network cabling application. Available in varying depths, these boxes are all equipped with concentric knockouts on all four sides for every TSR size of raceway which eliminates routing and installation inconvenience. All three styles of junction boxes come with adhesive strips on the back of the base and also #6 screws to secure the box to the base. See page 62 for knockout sizes and locations.

TSRP — Power Surface Raceway Accessories

HellermannTyton provides a complete line of fittings to manage connectivity requirements from the telecommunications room to the work area. Each size of raceway offers numerous fittings, offered in electrical ivory, white or office white, including TIA/EIA-568-B compliant 1" bend radius accessories which help ensure consistent data transmission performance of Category 5, 5e and 6 communications systems.

Product Selection



Designated with -50



Designated with -25-1



Designated with -33-1



Designated with -36



Designated with -12



Designated with -14



Designated with -29-1



Designated with -21-1



◆ Recommend using the TSRPX-JB2 for voice and data applications

Part Number	Description	Pkg. Qty.
TSRP1 Fittings		
TSRP1X-14	Splice Cover – 3/4"	10
TSRP1X-21-1	Tee – 3/4" – 1" Bend Radius	10
TSRP1X-25-1	Elbow – 3/4" – 1" Bend Radius	10
TSRP1X-29-1	External Corner – 3/4" – 1" Bend Radius	10
TSRP1X-33-1	Internal Corner – 3/4" – 1" Bend Radius	10
TSRP1X-36	End Cap – 3/4"	10
TSRP1X-50	Ceiling Drop – 3/4"*	10
TSRP2 Fittings		
TSRP2X-14	Splice Cover – 1-1/4"	10
TSRP2X-21-1	Tee – 1-1/4" – 1" Bend Radius	10
TSRP2X-25-1	Elbow – 1-1/4" – 1" Bend Radius	10
TSRP2X-29-1	External Corner – 1-1/4" – 1" Bend Radius	10
TSRP2X-33-1	Internal Corner – 1-1/4" – 1" Bend Radius	10
TSRP2X-36	End Cap – 1-1/4"	10
TSRP2X-50	Ceiling Drop – 1-1/4"*	10
TSRP3 Fittings		
TSRP3X-14	Splice Cover – 1-3/4"	10
TSRP3X-21-1	Tee – 1-3/4" – 1" Bend Radius	10
TSRP3X-25-1	Elbow – 1-3/4" – 1" Bend Radius	10
TSRP3X-29-1	External Corner – 1-3/4" – 1" Bend Radius	10
TSRP3X-33-1	Internal Corner – 1-3/4" – 1" Bend Radius	10
TSRP3X-36	End Cap – 1-3/4"	10
TSRP3X-50	Ceiling Drop – 1-3/4"*	10
Reducers		
TSRP1X-12	Reducer – 1-3/4" to 1-1/4" (TSRP3 to TSRP2)	10
TSRP2X-12	Reducer – 1-3/4" to 3/4" (TSRP3 to TSRP1)	10
TSRP3X-12	Reducer – 1-1/4" to 3/4" (TSRP2 to TSRP1)	10
Junction Boxes		
TSRPX-JB1	Junction Box Single Gang – 3"(W) x 4.75"(L) x 1.25" (H)	1
TSRPX-JB2 ◆	Junction Box Single Gang – 3"(W) x 4.75"(L) x 2" (H)	1
TSRPX-JBD	Junction Box Dual Gang – 4.91"(W) x 4.83"(L) x 1.5" (H)	1

Replace "X" in the part number with the following letters for desired color: X = I (ivory), FW (office white), W (white) * Note: TSRPXX-50 accepts 1/2" and 3/4" conduit.

Junction Boxes

Offered in a dual or single gang format, HellermannTyton's power-rated junction boxes are versatile enough for any network cabling application. Available in varying depths, these boxes are all equipped with concentric knockouts on all four sides for every TSRP size of raceway which eliminates routing and installation inconvenience. All three styles of junction boxes come with adhesive strips on the back of the base and #6 screws to secure the box to the base. See page 62 for knockout sizes and locations.

TSR and TSRP Surface Raceway Systems

Wire Fill Chart

Wire Type	Wire Size	O.D. of Wire	Low Voltage - TSR						Power Rated - TSRP					
			TSR1 A = 0.220 in ²		TSR2 A = 0.675 in ²		TSR3 A = 1.384 in ²		TSRP 1 A = 0.220 in ²		TSRP 2 A = 0.651 in ²		TSRP3 A = 1.361 in ²	
			Spec	Max	Spec	Max	Spec	Max	Spec	Max	Spec	Max	Spec	Max
Twisted Pair 24 AWG Unshielded	2 Pr.	0.140	5	8	17	26	35	53	5	8	16	25	35	53
	3 Pr.	0.150	4	7	15	22	31	46	4	7	14	22	30	46
	4 Pr. Cat 5e	0.217	2	3	7	10	14	22	2	3	7	10	14	22
	4 Pr. Cat 6	0.240	1	2	5	8	12	18	1	2	5	8	12	18
	25 Pr.	0.410	0	0	2	3	4	6	0	0	1	2	4	6
	4 Pr. Cat 6a	0.354	0	1	2	4	5	8	0	1	2	3	5	8
Coax	RG58/U	0.193	3	4	9	13	18	28	2	4	8	13	18	27
	RG59/U or RG62/U	0.242	1	2	5	8	12	18	1	2	4	6	9	14
	RG6/U	0.270	1	2	4	7	9	14	1	2	4	6	9	14
Fiber Optic FA Jacket OFNP	2 Strand	0.175	3	5	11	16	23	34	3	5	10	16	22	33
	4 Strand	0.185	3	4	10	15	20	30	3	4	9	14	20	30
	6 Strand	0.210	2	3	7	11	15	23	2	3	7	11	15	23
Electrical Wire	14 AWG THHN	0.105	-	-	-	-	-	-	-	8	-	11	-	15
	12 AWG THHN	0.122	-	-	-	-	-	-	-	6	-	9	-	12
	10 AWG THHN	0.153	-	-	-	-	-	-	-	4	-	6	-	7

Formula used to calculate communications wire fill capacity - Numbers of wires = duct / {1/4 x 3.14 x (wire o.d.)²} x 0.4 or 0.6. Per ANSI/TIA/EIA-569-A:
 SPEC = 40% fill which is recommended for planning perimeter pathways
 MAX (for data) = 60% fill which is allowed to accommodate unplanned additions after initial installation
 MAX (for power) = Maximum number determined by UL temperature testing
 Note: It is recommended to place electrical cables loosely in raceway

TSR and TSRP Junction Box Knockout Locations

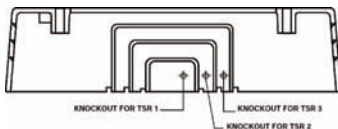
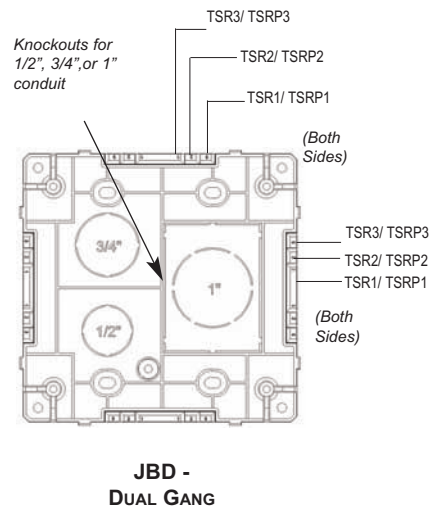
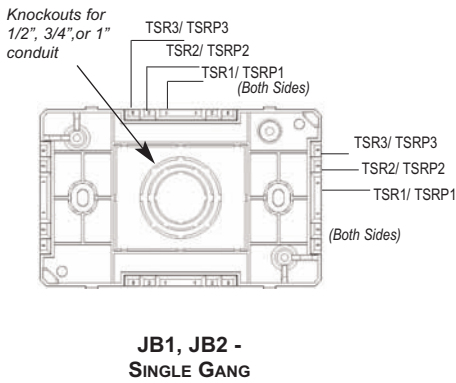

INFOSTREAM® Multi-Channel Raceway



HellermannTyton's InfoStream is a revolutionary design for a non-metallic raceway system. The elliptical shape is aesthetically pleasing when compared to other designs. By using the three rails to snap in dividers, the InfoStream system can accommodate up to four separate channels of electrical, voice, data, video or fiber optic cabling. InfoStream's unique and patented design make installations quicker and easier. The raceway and fittings are manufactured from a UL 94V-0 rated material.

- All fittings have been designed to maintain the required 1" minimum bend radius per TIA/EIA-568-B and 569-A standards.
- U.L. Listed to 600 Volts – Meets new UL5A and CSA 22.2 No. 62-93 standards.
- Patented hinged cover speeds installation time by allowing installer to partially mount cover prior to laying cables.
- Light weight also eases installation and reduces labor costs.
- Offset elbow is the only solution currently on the market for wall offsets between 2-7" .
- Mates directly with HellermannTyton's TSR and TSRP - single channel raceway system.
- System is designed to accept all NEMA standard faceplates and devices.
- Offset box gives installer the option to offset electrical outlet above or below raceway.
- Cable tie mount retains cables inside of channel if necessary and accepts standard HellermannTyton cable ties.
- Entrance end fitting allows entrance into raceway from ceiling or through wall.



INFOSTREAM®
Multi-Channel Raceway Diagram

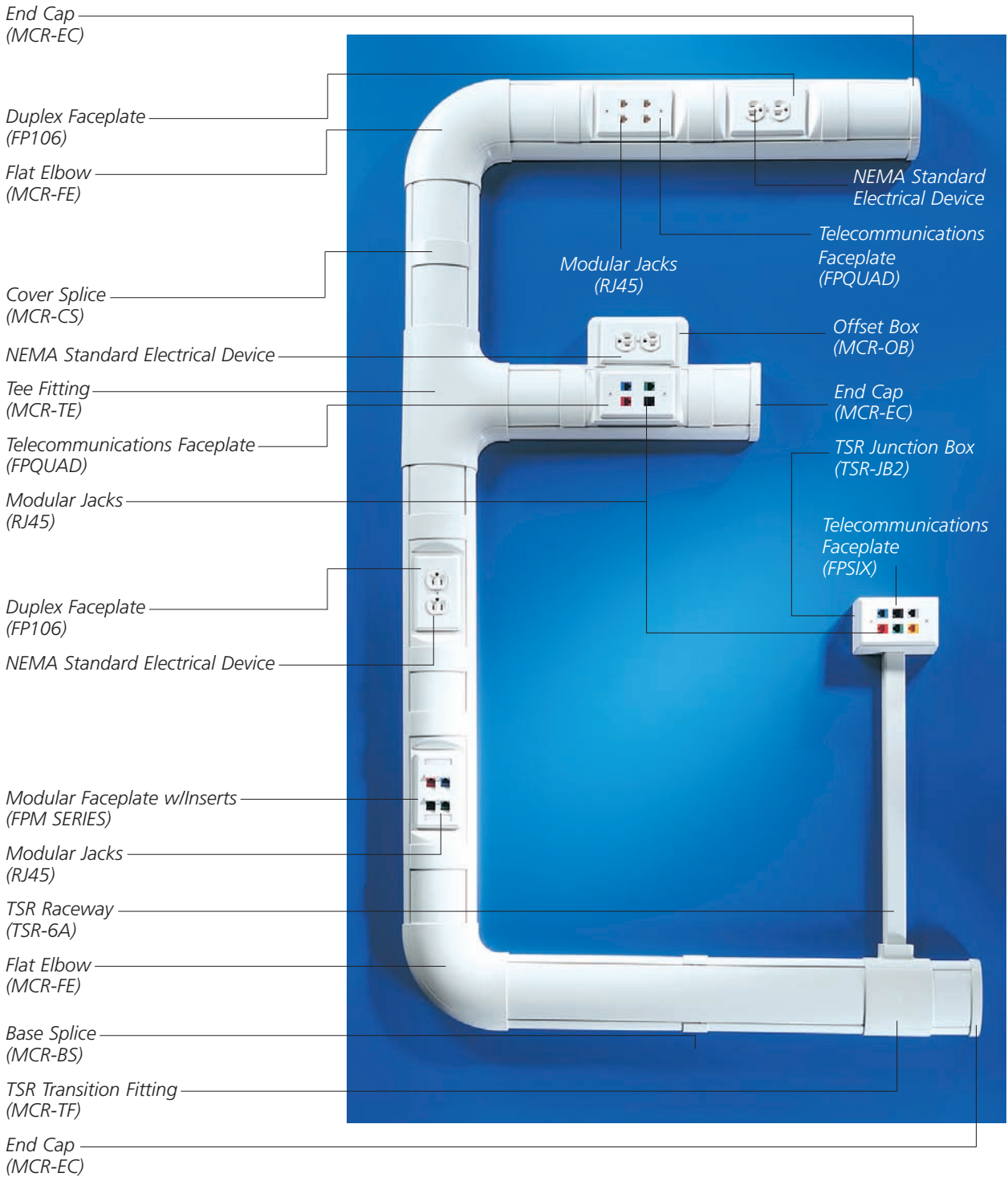

**INFOSTREAM®
Multi-Channel Raceway**

Power and Data Only



Power Only Configuration

Components: Raised Electrical Device Bracket (MCR-REB)
Area: 2.50 sq. in.



Data Only Configuration

Components: Raised Communications Device Bracket (MCR-RDB)
Area: 3.08 sq. in.

Power and Data Inline



**High Data Capacity Option
With Side Divider**

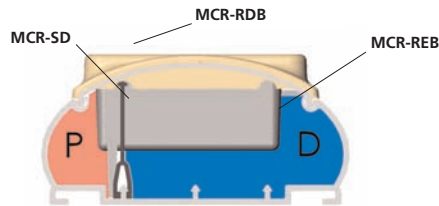

High Capacity / Side Divider Configuration

Components:

- Raceway Side Divider (MCR-SD)
- Raised Device Bracket (MCR-RDB)
- Raised Electrical Bracket (MCR-REB)

 Data Area: 2.45 sq. in.
Power Area: 0.80 sq. in.

Offset Box with Data

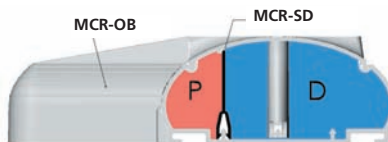

Offset Box with Data Configuration

Components:

- Offset Box (MCR-OB)
- Raceway Side Divider (MCR-SD)

 Data Area: 4.26 sq. in.
Power Area: 1.22 sq. in.

INFOSTREAM®
Multi-Channel Raceway



Unique, streamlined design enhances the aesthetics of any installation.

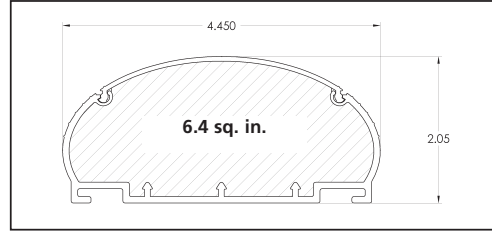

Hinged cover speeds installation.



Multi-Channel Raceway Base

Base is supplied with pre-punched mounting slots every 8". Raceway base also includes adhesive double-sided tape for aid in mounting. Raceway must still be properly fastened to the wall per included instructions.

Product Selection

Part Number	Description	Pkg. Qty.
MCRX-BS8	Raceway Base – 8 feet with side divider	48 feet
MCRX-BS10	Raceway Base – 10 feet with side divider	60 feet



Replace "X" in the part number with the following letters for desired color:
X = I (ivory), FW (office white)

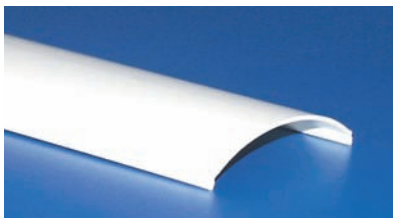

Multi-Channel Raceway Cover

Product Selection

Part Number	Description	Pkg. Qty.
MCRX-C8	Raceway Cover – 8 feet	48 feet
MCRX-C10	Raceway Cover – 10 feet	60 feet



Replace "X" in the part number with the following letters for desired color:
X = I (ivory), FW (office white)

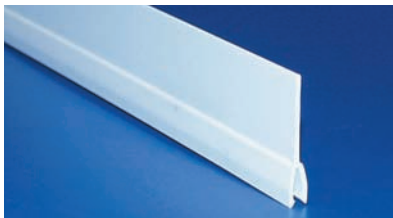

Multi-Channel Raceway Divider

Product Selection

Snaps onto either side of raceway base rails for proper power and data separation per UL/CSA.

Part Number	Description	Pkg. Qty.
MCRW-SD8	White Raceway Side Divider – 8 feet	96 feet
MCRW-SD10	White Raceway Side Divider – 10 feet	120 feet



INFOSTREAM®
Multi-Channel Raceway



Flat Elbow

Joins raceway at 90° flat angle.

Product Selection

Part Number	Description	Pkg. Qty.
MCRX-FE	Flat Elbow	1

 Replace "X" in the part number with the following letters for desired color: X = I (ivory), FW (office white)



External Elbow

Joins raceway at 90° outside corner.

Product Selection

Part Number	Description	Pkg. Qty.
MCRX-EE	External Elbow	1

 Replace "X" in the part number with the following letters for desired color: X = I (ivory), FW (office white)



Internal Elbow

Joins raceway at 90° inside corner.

Product Selection

Part Number	Description	Pkg. Qty.
MCRX-IE	Internal Elbow	1

 Replace "X" in the part number with the following letters for desired color: X = I (ivory), FW (office white)



End Cap

Completes raceway or provides transition for 1/2", 3/4" and 1" conduit.

Product Selection

Part Number	Description	Pkg. Qty.
MCRX-EC	End Cap	1

 Replace "X" in the part number with the following letters for desired color: X = I (ivory), FW (office white)

INFOSTREAM®
Multi-Channel Raceway

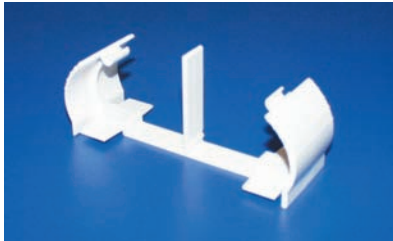

Base Splice

Joins 2 sections of raceway base.

Product Selection

Part Number	Description	Pkg. Qty.
MCRX-BS	Base Splice	10

 Replace "X" in the part number with the following letters for desired color:
X = I (ivory), FW (office white)

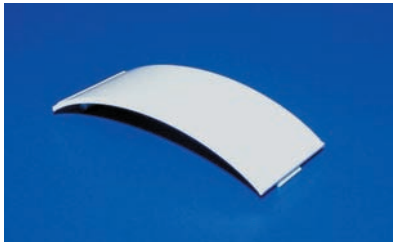

Cover Splice

Joins 2 sections of raceway cover.

Product Selection

Part Number	Description	Pkg. Qty.
MCRX-CS	Cover Splice	10

 Replace "X" in the part number with the following letters for desired color:
X = I (ivory), FW (office white)

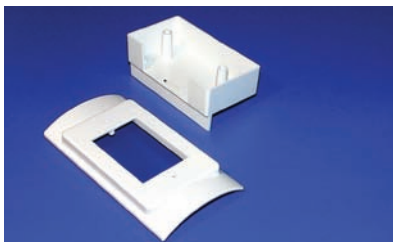

Raised Electrical Box

Used to mount NEMA standard single gang device and face-plate. Raised electrical box allows for additional low voltage wire fill space. Use with side divider for 2-channel applications.

Product Selection

Part Number	Description	Pkg. Qty.
MCRX-REB	Raised Electrical Bracket Fitting	5

 Replace "X" in the part number with the following letters for desired color:
X = I (ivory), FW (office white)

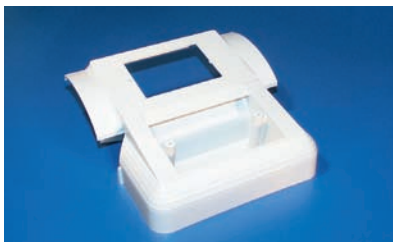

Offset Box

Option for communications devices in raceway and electrical outlets on side.

Product Selection

Part Number	Description	Pkg. Qty.
MCRX-OB	Offset Box	1

 Replace "X" in the part number with the following letters for desired color:
X = I (ivory), FW (office white)

INFOSTREAM®
Multi-Channel Raceway



Transition Fitting

Knockouts are provided for TSR1, TSR2, and TSR3 surface raceway.

Product Selection

Part Number	Description	Pkg. Qty.
MCRX-TF	Transition Fitting	1

 Replace "X" in the part number with the following letters for desired color:
X = I (ivory), FW (office white)



Power Transition Fitting

Knockouts are provided for TSRP1, TSRP2, and TSRP3 surface raceway.

Product Selection

Part Number	Description	Pkg. Qty.
MCRX-PTF	Power Transition Fitting	1

 Replace "X" in the part number with the following letters for desired color:
X = I (ivory), FW (office white)

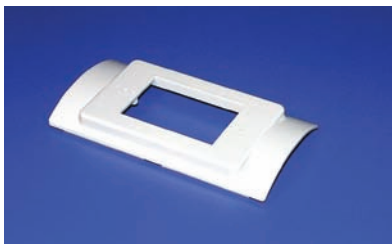

Raised Device Bracket

Used to mount NEMA standard single gang device and faceplate. Raised bracket allows for additional wire fill space and additional device clearance. Use with side divider for 2-channel applications.

Product Selection

Part Number	Description	Pkg. Qty.
MCRX-RDB	Raised Device Bracket Fitting	10

 Replace "X" in the part number with the following letters for desired color:
X = I (ivory), FW (office white)



Entrance End Fitting

For use as a ceiling drop, conduit transition from end or base of raceway, or low voltage entrance from end or base of raceway. Includes dual 0.75", 1.0", 1.25", 1.75", 2", and 2.5" knockouts.

Product Selection

Part Number	Description	Pkg. Qty.
MCRX-ENT	Entrance End Fitting	1

 Replace "X" in the part number with the following letters for desired color:
X = I (ivory), FW (office white)

INFOSTREAM®
Multi-Channel Raceway

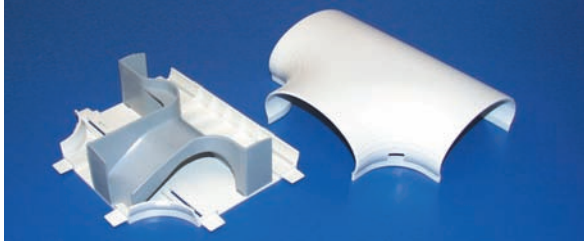

Tee Fitting

Joins 3 sections of raceway and includes divider.

Product Selection

Part Number	Description	Pkg. Qty.
MCRX-TE	Tee Fitting	1

 Replace "X" in the part number with the following letters for desired color: X = I (ivory), FW (office white)

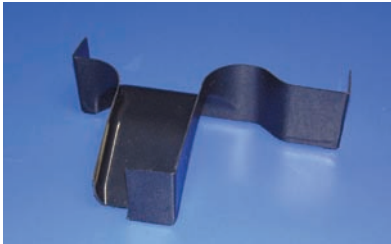

Tee Fitting - Left Side

Divides power and communications cables on the opposite side.

Product Selection

Part Number	Description	Pkg. Qty.
MCR-LTD	Tee Fitting Divider - left side	1





Wire Retainer/Tie Mount

Wire retainer keeps wire & cable in place. Recommend placement every 18" to 24". Tie mount keeps wire & cable bundled. Accepts standard HellermannTyton cable ties T18-T50.

Product Selection

Part Number	Description	Pkg. Qty.
MCRG-WR	Wire Retainer – Gray	10
MCRG-TM	Tie Mount – Gray	100



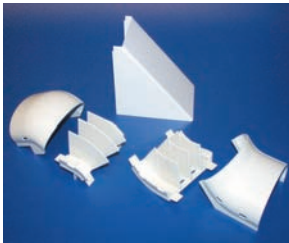

Offset Elbow

For small wall offsets between 2"-7". Used in conjunction with piece of raceway. Corner filler included for a flush appearance.

Product Selection

Part Number	Description	Pkg. Qty.
MCRX-OE	Offset Elbow	1

 Replace "X" in the part number with the following letters for desired color: X = I (ivory), FW (office white)

INFOSTREAM®
Multi-Channel Raceway

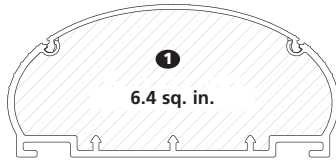

Base and Cover with No Devices

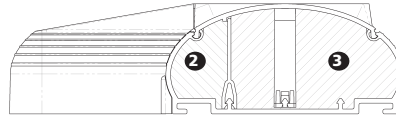

Offset Box with Data (OB)

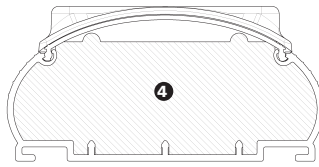

Data Only using Raised Bracket (RDB)

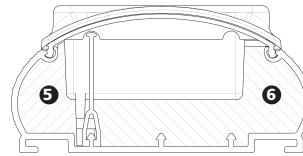

Power and Data Inline using Raised Brackets (REB, RDB)

Wire Fill Capacity

LOW VOLTAGE		Raceway Area of Raceway	Channel 1 6.40in ²	Channel 2 1.220in ²	Channel 3 4.260in ²	Channel 4 5.880in ²	Channel 5 0.800in ²	Channel 6 2.450in ²
Wire Type	Wire Size	OD of Wire	Spec Max	Spec Max	Spec Max	Spec Max	Spec Max	Spec Max
Twisted Pair 24 AWG Unshielded	2 Pr.	0.140	166 249	31 47	110 166	152 229	20 31	63 95
	3 Pr.	0.150	144 217	27 41	96 144	133 199	18 27	55 83
	4 Pr. Cat 5e	0.217	69 103	13 19	46 69	63 95	8 12	26 39
	4 Pr. Cat 6	0.240	56 84	10 16	37 56	51 77	7 10	21 32
	4 Pr. Cat 6a	0.354	26 39	4 7	17 25	23 35	3 4	9 14
	25 Pr.	0.410	19 29	3 5	12 19	17 26	2 3	7 11
Coax	RG58/U	0.193	87 131	16 25	58 87	80 120	10 16	33 50
	RG59/U or RG62/U	0.242	55 83	10 15	37 55	51 76	6 10	21 31
	RG6/U	0.270	44 67	8 12	29 44	41 61	5 8	17 25
Fiber Optic FA Jacket OFNP	2 Strand	0.175	106 159	20 30	70 106	97 146	13 19	40 61
	4 Strand	0.185	95 142	18 27	63 95	87 131	11 17	36 54
	6 Strand	0.210	73 110	14 21	49 73	67 101	9 13	28 42
Fiber Optic 62.5/125/900 PVC Jacket OFNR	2 Strand	0.175	106 159	20 30	70 106	97 146	13 19	40 61
	4 Strand	0.185	95 142	18 27	63 95	87 131	11 17	36 54
	6 Strand	0.210	73 110	14 21	49 73	67 101	9 13	28 42
	8 Strand	0.230	61 92	11 17	41 61	56 84	7 11	23 35
	10 Strand	0.250	52 78	9 14	34 52	47 71	6 9	19 29
Electrical Wire	14 AWG THHN	0.105	30	21	-	27	14	-
	12 AWG THHN	0.122	25	15	-	22	11	-
	10 AWG THHN	0.153	19	9	-	17	8	-

Formula used to calculate communications wire fill capacity - Numbers of wires = duct / {1/4 x 3.14 x (wire o.d.)² x 0.4 or 0.6.

Per ANSI/TIA/EIA-569-A-:

SPEC = 40% fill which is recommended for planning perimeter pathways

MAX (for data) = 60% fill which is allowed to accommodate unplanned additions after initial installation

MAX (for power) = Maximum number determined by UL temperature testing

Note: It is recommended to place electrical cables loosely in raceway

Wiring Duct

HellermannTyton manufactures wiring duct from high impact and rigid PVC for routing and protecting wire and cable.

The slotted duct features break-away fingers which provide additional access for wire and cable. Each section of slotted duct is provided with two score lines. The first one is at the base of the finger which allows the finger to be bent and broken away when a greater opening is required. The second score line is lower which allows a section of the sidewall to be easily removed by simply cutting the sidewall down to the lower score line and snapping out the desired section. These two score lines provide smooth edges to ensure user comfort and cable safety. For straight wire runs where break-outs are not required, HellermannTyton also provides solid wall duct. The covers are flush with the side of the duct and also are provided with a non-slip plastic lining to ensure that the covers remain in place. **The covers must be ordered separately.**

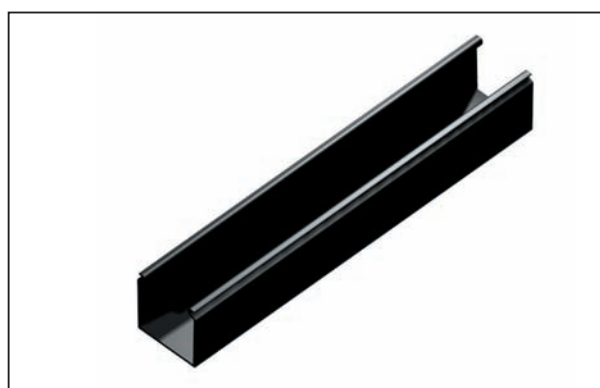
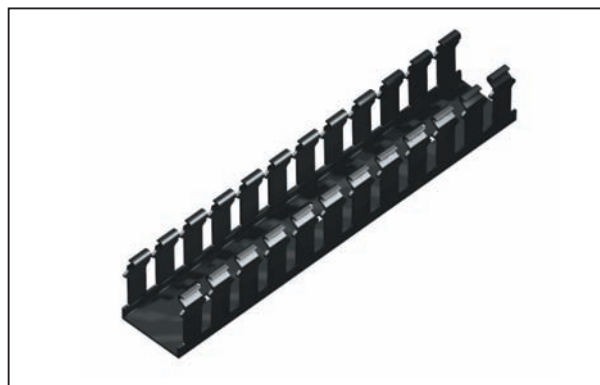

Wiring Duct

Product Selection

Part Number	Description	*Color	Pkg. Qty.
SL1X1BK4	1" (W) x 1" (H) x 6' (L) Slotted Duct	Black	120 feet of 6 foot lengths
SL1X4BK4	1" (W) x 4" (H) x 6' (L) Slotted Duct	Black	120 feet of 6 foot lengths
SL1.5X4BK4	1.5" (W) x 4" (H) x 6' (L) Slotted Duct	Black	120 feet of 6 foot lengths
SL1.5X1.5BK4	1.5" (W) x 1.5" (H) x 6' (L) Slotted Duct	Black	120 feet of 6 foot lengths
SL1.5X2BK4	1.5" (W) x 2" (H) x 6' (L) Slotted Duct	Black	120 feet of 6 foot lengths
SL2X2BK4	2" (W) x 2" (H) x 6' (L) Slotted Duct	Black	120 feet of 6 foot lengths
SL2X3BK4	2" (W) x 3" (H) x 6' (L) Slotted Duct	Black	120 feet of 6 foot lengths
SL2X4BK4	2" (W) x 4" (H) x 6' (L) Slotted Duct	Black	120 feet of 6 foot lengths
SL3X2BK4	3" (W) x 2" (H) x 6' (L) Slotted Duct	Black	120 feet of 6 foot lengths
SL3X3BK4	3" (W) x 3" (H) x 6' (L) Slotted Duct	Black	120 feet of 6 foot lengths
SL3X4BK4	3" (W) x 4" (H) x 6' (L) Slotted Duct	Black	120 feet of 6 foot lengths
SL3X5BK4	3" (W) x 5" (H) x 6' (L) Slotted Duct	Black	60 feet of 6 foot lengths
SL4X4BK4	4" (W) x 4" (H) x 6' (L) Slotted Duct	Black	120 feet of 6 foot lengths
SL4X5BK4	4" (W) x 5" (H) x 6' (L) Slotted Duct	Black	60 feet of 6 foot lengths
SD1X1BK4	1" (W) x 1" (H) x 6' (L) Solid Duct	Black	120 feet of 6 foot lengths
SD1.5X1.5BK4	1.5" (W) x 1.5" (H) x 6' (L) Solid Duct	Black	120 feet of 6 foot lengths
SD2X2BK4	2" (W) x 2" (H) x 6' (L) Solid Duct	Black	120 feet of 6 foot lengths
SD3X3BK4	3" (W) x 3" (H) x 6' (L) Solid Duct	Black	120 feet of 6 foot lengths
SD4X4BK4	4" (W) x 4" (H) x 6' (L) Solid Duct	Black	120 feet of 6 foot lengths
SD4X5BK4	4" (W) x 5" (H) x 6' (L) Solid Duct	Black	120 feet of 6 foot lengths
TC1BK4	Cover for 1" Wide Duct	Black	120 feet of 6 foot lengths
TC1.5BK4	Cover for 1.5" Wide Duct	Black	120 feet of 6 foot lengths
TC2BK4	Cover for 2" Wide Duct	Black	120 feet of 6 foot lengths
TC3BK4	Cover for 3" Wide Duct	Black	120 feet of 6 foot lengths
TC4BK4	Cover for 4" Wide Duct	Black	120 feet of 6 foot lengths

*Also available in standard White and Gray – Call for availability of additional sizes.

Pro-Duct Wiring Duct

HellermannTyton's Pro-Duct wiring duct efficiently routes and protects wire and cable. Manufactured from high impact, rigid PVC, Pro-Duct includes solid, slotted and high density slotted styles. Available in over 28 sizes, Pro-Duct comes in standard colors of white, gray and black in 6 foot lengths. Blue wiring duct is also available in a variety of standard sizes. Other colors are available. Contact HellermannTyton for minimum volume requirements.

Pro-Duct Features

All styles of Pro-Duct wiring duct (solid, slotted and high density slotted) are designed with many installer preferred features:

- Smooth edges protect installer and wires from abrasion.
- Cover is flush with the side of the duct for increased wire capacity. It also allows for tight, side-by-side placement.
- No cover slippage. The covers are provided with a non-slip plastic lining. This ensures that the covers remain in place during vibration, yet they easily snap on and off, offering ready access to the wire run.
- Mounting holes are designed for installation versatility. Elongated mounting holes allow for changes in panel designs and installation flexibility.
- Mounting holes are standard. Contact HellermannTyton for duct without mounting holes.
- Enhanced wire capacity helps maximize space within panels.
- Interchangeable covers between solid, slotted, and high density slotted styles reduce inventory and increase versatility.
- Professional appearance increases panel's overall neatness.

Pro-Duct is U.L. Recognized, CSA Certified, and carries a U.L. flame rating of 94V0.



Solid Wall Duct

Solid wall duct is designed for straight wire runs where break-outs are not required.

- Smooth edges
- Non-slip cover
- Professional appearance



Slotted Wall Duct

Slotted wall duct features break-away fingers which provide additional access for wire leads.

Slotted wall duct is manufactured with two score lines.

The first score line is at the base of the finger, allowing the finger to be bent and broken away when a greater opening is required. The second score line is lower allowing a section of the sidewall to be easily removed by cutting the sidewall down to the lower score line. Use HellermannTyton's TDNT notching tool and snap out the desired section. Both score lines provide smooth edges to ensure worker safety.

Strong fingers prevent unwanted breaking.

The fingers are easily deflected outward, allowing ready positioning of the wires within the slotted wall duct.

Restricted opening design in the finger of the duct helps keep wires in place.

Restriction also prevents unintended removal of wires and permits any individual wire to be traced without disconnection.



High Density Slotted Duct

High density slotted wall duct comes with narrow fingers, equaling a 2-to-1 finger ratio compared to standard slotted wiring duct.

Narrow fingers reduce fanning of the wires to the terminal blocks.

Compact designs and components are more easily accommodated with the high density duct's 2-to-1 finger ratio.

High density duct also incorporates the double scored design, similar to the standard slotted wall duct.

With sizes 2" high and above, high density duct features a double restriction on each finger of the duct.

The double restriction helps retain wires in the bottom portion of the duct for easier installation.

Mounting holes are uniform in size to the solid and slotted wall duct but are offered every 2 inches to accommodate compact designs and installations.



Adhesive Backing

Most sizes of Pro-Duct wiring duct are available with a pressure sensitive, rubber based adhesive backing. The adhesive backing can be utilized for temporary positioning or permanent mounting. This is an optional feature and must be specified when ordering. For part number information, contact HellermannTyton or see notation at the end of each duct dimensional chart.

Please note: Adhesive duct orders are non-cancellable and non-returnable.

Duct Width	Rows of Tape	Tape Width
.50"	1	3/8"
.75"	1	1/2"
1.0"	1	3/4"
1.5"	1	1-1/8"
2.0"	2	3/4"
3.0"	2	3/4"
4.0"	2	3/4"

Modular Packaging

Pro-Duct wiring duct is available in modular, easy to stock packaging. Each master carton contains 120 feet of duct divided into four inner cartons of 30 feet each. This better serves the inventory needs of users who require smaller quantities of several sizes. Due to weight restrictions, 3" x 5" and 4" x 5" sizes are only available in bulk packaging. To order modular packaging, remove the last digit "4" from the duct or cover part number.

Wiring Duct

Solid Wall Duct

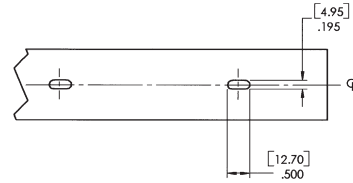
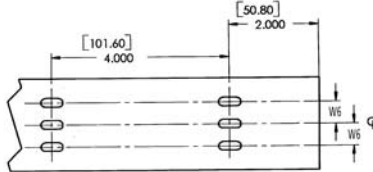
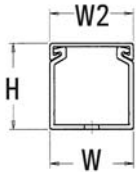

File # E64139 File # 49249

Product Selection			Width (W)	Height (H)	Width (W2)	Width (W6)	Description	Color	Pkg. Qty.
Article No.	Part No.	Type	in. (mm)	in. (mm)	in. (mm)	in. (mm)			ft. (6 ft. lengths)
.5" x .5" (12.7 x 12.7) Nominal Duct Size									
181-00453	SD.5X.5W4	SD.5X.5	.50" (12.7)	.55" (14.0)	.76" (19.3)	One row of holes on ☉	Non-Adhesive	White	120 ft
181-00525	SDA.5X.5W4	SDA.5X.5					Adhesive	White	120 ft
181-00452	SD.5X.5G4	SD.5X.5					Non-Adhesive	Gray	120 ft
181-00524	SDA.5X.5G4	SDA.5X.5					Adhesive	Gray	120 ft
181-05500	SD.5X.5BK4	SD.5X.5					Non-Adhesive	Black	120 ft
181-00481	SDA.5X.5BK4	SDA.5X.5					Adhesive	Black	120 ft
.5" x 1" (12.7 x 25.4) Nominal Duct Size									
181-00143	SD.5X1W4	SD.5X1	.50" (12.7)	1.05" (26.7)	.76" (19.3)	One row of holes on ☉	Non-Adhesive	White	120 ft
181-00528	SDA.5X1W4	SDA.5X1					Adhesive	White	120 ft
181-00145	SD.5X1G4	SD.5X1					Non-Adhesive	Gray	120 ft
181-00526	SDA.5X1G4	SDA.5X1					Adhesive	Gray	120 ft
181-00144	SD.5X1BK4	SD.5X1					Non-Adhesive	Black	120 ft
181-00527	SDA.5X1BK4	SDA.5X1					Adhesive	Black	120 ft
.75" x .75" (19.1 x 19.1) Nominal Duct Size									
181-00456	SD.75X.75W4	SD.75X.75	.75" (19.1)	.80" (20.3)	1.01" (25.7)	One row of holes on ☉	Non-Adhesive	White	120 ft
181-00142	SDA.75X.75W4	SDA.75X.75					Adhesive	White	120 ft
181-00455	SD.75X.75G4	SD.75X.75					Non-Adhesive	Gray	120 ft
181-00140	SDA.75X.75G4	SDA.75X.75					Adhesive	Gray	120 ft
181-00454	SD.75X.75BK4	SD.75X.75					Non-Adhesive	Black	120 ft
181-00141	SDA.75X.75BK4	SDA.75X.75					Adhesive	Black	120 ft
1" x 1" (25.4 x 25.4) Nominal Duct Size									
181-11005	SD1X1W4	SD1X1	1.00" (25.4)	1.05" (26.7)	1.00" (25.4)	One row of holes on ☉	Non-Adhesive	White	120 ft
181-11008	SDA1X1W4	SDA1X1					Adhesive	White	120 ft
181-11002	SD1X1G4	SD1X1					Non-Adhesive	Gray	120 ft
181-00493	SDA1X1G4	SDA1X1					Adhesive	Gray	120 ft
181-11000	SD1X1BK4	SD1X1					Non-Adhesive	Black	120 ft
181-00492	SDA1X1BK4	SDA1X1					Adhesive	Black	120 ft
1" x 1.5" (25.4 x 38.1) Nominal Duct Size									
181-11502	SD1X1.5W4	SD1X1.5	1.02" (25.9)	1.56" (39.6)	1.00" (25.4)	One row of holes on ☉	Non-Adhesive	White	120 ft
181-00491	SDA1X1.5W4	SDA1X1.5					Adhesive	White	120 ft
181-11501	SD1X1.5G4	SD1X1.5					Non-Adhesive	Gray	120 ft
181-00490	SDA1X1.5G4	SDA1X1.5					Adhesive	Gray	120 ft
181-00457	SD1X1.5BK4	SD1X1.5					Non-Adhesive	Black	120 ft
181-00529	SDA1X1.5BK4	SDA1X1.5					Adhesive	Black	120 ft

Dimensions are approximate and subject to technical changes. Use **Part No.** for ordering and **Type** for specification purposes.

Solid wall duct in larger sizes continued on the next page. Covers are listed on page 117.

Solid Wall Duct

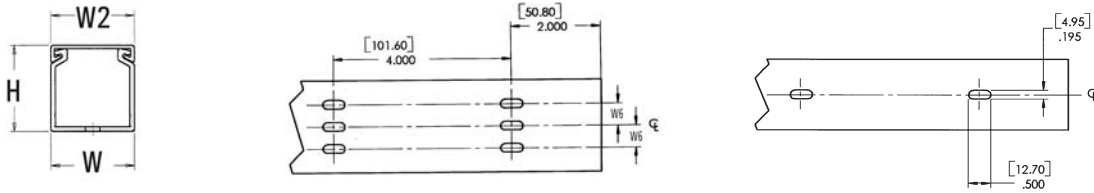

File # E64139 File # 49249

Product Selection			Width (W)	Height (H)	Width (W2)	Width (W6)	Description	Color	Pkg. Qty.
Article No.	Part No.	Type	in. (mm)	in. (mm)	in. (mm)	in. (mm)			ft. (6 ft. lengths)
1" x 2" (25.4 x 50.8) Nominal Duct Size									
181-12002	SD1X2W4	SD1X2	1.03" (26.2)	2.06" (52.3)	1.00" (25.4)	One row of holes on Φ	Non-Adhesive	White	120 ft
181-00495	SDA1X2W4	SDA1X2					Adhesive	White	120 ft
181-12001	SD1X2G4	SD1X2					Non-Adhesive	Gray	120 ft
181-00494	SDA1X2G4	SDA1X2					Adhesive	Gray	120 ft
181-00458	SD1X2BK4	SD1X2					Non-Adhesive	Black	120 ft
181-00530	SDA1X2BK4	SDA1X2					Adhesive	Black	120 ft
1" x 3" (25.4 x 76.2) Nominal Duct Size									
181-13001	SD1X3W4	SD1X3	1.02" (25.9)	3.06" (77.7)	1.00" (25.4)	One row of holes on Φ	Non-Adhesive	White	120 ft
181-00496	SDA1X3W4	SDA1X3					Adhesive	White	120 ft
181-00136	SD1X3G4	SD1X3					Non-Adhesive	Gray	120 ft
181-00671	SDA1X3G4	SDA1X3					Adhesive	Gray	120 ft
181-00459	SD1X3BK4	SD1X3					Non-Adhesive	Black	120 ft
181-00531	SDA1X3BK4	SDA1X3					Adhesive	Black	120 ft
1" x 4" (25.4 x 101.6) Nominal Duct Size									
181-14000	SD1X4W4	SD1X4	1.00" (25.4)	4.06" (103.1)	1.00" (25.4)	One row of holes on Φ	Non-Adhesive	White	120 ft
181-00497	SDA1X4W4	SDA1X4					Adhesive	White	120 ft
181-00461	SD1X4G4	SD1X4					Non-Adhesive	Gray	120 ft
181-00533	SDA1X4G4	SDA1X4					Adhesive	Gray	120 ft
181-00460	SD1X4BK4	SD1X4					Non-Adhesive	Black	120 ft
181-00532	SDA1X4BK4	SDA1X4					Adhesive	Black	120 ft
1.5" x 1" (38.1 x 25.4) Nominal Duct Size									
181-15102	SD1.5X1W4	SD1.5X1	1.50" (38.1)	1.05" (26.7)	1.50" (38.1)	One row of holes on Φ	Non-Adhesive	White	120 ft
181-00486	SDA1.5X1W4	SDA1.5X1					Adhesive	White	120 ft
181-15101	SD1.5X1G4	SD1.5X1					Non-Adhesive	Gray	120 ft
181-00025	SDA1.5X1G4	SDA1.5X1					Adhesive	Gray	120 ft
181-15100	SD1.5X1BK4	SD1.5X1					Non-Adhesive	Black	120 ft
181-00485	SDA1.5X1BK4	SDA1.5X1					Adhesive	Black	120 ft
1.5" x 1.5" (38.1 x 38.1) Nominal Duct Size									
181-15503	SD1.5X1.5W4	SD1.5X1.5	1.52" (38.6)	1.56" (39.6)	1.50" (38.1)	One row of holes on Φ	Non-Adhesive	White	120 ft
181-15504	SDA1.5X1.5W4	SDA1.5X1.5					Adhesive	White	120 ft
181-15502	SD1.5X1.5G4	SD1.5X1.5					Non-Adhesive	Gray	120 ft
181-00483	SDA1.5X1.5G4	SDA1.5X1.5					Adhesive	Gray	120 ft
181-15500	SD1.5X1.5BK4	SD1.5X1.5					Non-Adhesive	Black	120 ft
181-00482	SDA1.5X1.5BK4	SDA1.5X1.5					Adhesive	Black	120 ft

Dimensions are approximate and subject to technical changes. Use **Part No.** for ordering and **Type** for specification purposes.

Solid wall duct in larger sizes continued on the next page. Covers are listed on page 117.

Wiring Duct

Solid Wall Duct

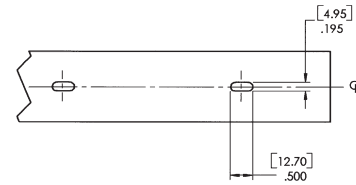
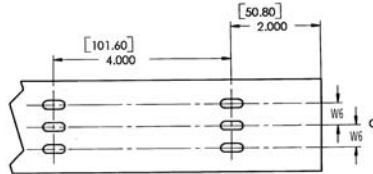
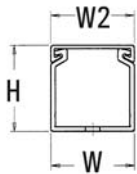

Product Selection			Width (W)	Height (H)	Width (W2)	Width (W6)	Description	Color	Pkg. Qty.
Article No.	Part No.	Type	in. (mm)	in. (mm)	in. (mm)	in. (mm)			ft. (6 ft. lengths)
1.5" x 2" (38.1 x 50.8) Nominal Duct Size									
181-15202	SD1.5X2W4	SD1.5X2	1.53" (38.9)	2.06" (52.3)	1.50" (38.1)	One row of holes on ⌀	Non-Adhesive	White	120 ft
181-00488	SDA1.5X2W4	SDA1.5X2					Adhesive	White	120 ft
181-15201	SD1.5X2G4	SD1.5X2					Non-Adhesive	Gray	120 ft
181-00487	SDA1.5X2G4	SDA1.5X2					Adhesive	Gray	120 ft
181-00462	SD1.5X2BK4	SD1.5X2					Non-Adhesive	Black	120 ft
181-00534	SDA1.5X2BK4	SDA1.5X2					Adhesive	Black	120 ft
1.5" x 3" (38.1 x 76.2) Nominal Duct Size									
181-00464	SD1.5X3W4	SD1.5X3	1.52" (38.6)	3.06" (77.7)	1.50" (38.1)	One row of holes on ⌀	Non-Adhesive	White	120 ft
181-00536	SDA1.5X3W4	SDA1.5X3					Adhesive	White	120 ft
181-15300	SD1.5X3G4	SD1.5X3					Non-Adhesive	Gray	120 ft
181-00489	SDA1.5X3G4	SDA1.5X3					Adhesive	Gray	120 ft
181-00463	SD1.5X3BK4	SD1.5X3					Non-Adhesive	Black	120 ft
181-00535	SDA1.5X3BK4	SDA1.5X3					Adhesive	Black	120 ft
1.5" x 4" (38.1 x 101.6) Nominal Duct Size									
181-00467	SD1.5X4W4	SD1.5X4	1.50" (38.1)	4.06" (103.1)	1.50" (38.1)	One row of holes on ⌀	Non-Adhesive	White	120 ft
181-00539	SDA1.5X4W4	SDA1.5X4					Adhesive	White	120 ft
181-00574	SD1.5X4G4	SD1.5X4					Non-Adhesive	Gray	120 ft
181-00538	SDA1.5X4G4	SDA1.5X4					Adhesive	Gray	120 ft
181-00465	SD1.5X4BK4	SD1.5X4					Non-Adhesive	Black	120 ft
181-00537	SDA1.5X4BK4	SDA1.5X4					Adhesive	Black	120 ft
2" x 1" (50.8 x 25.4) Nominal Duct Size									
181-21003	SD2X1W4	SD2X1	2.01" (51.1)	1.05" (26.7)	2.00" (50.8)	Three rows of holes .50" (12.7)	Non-Adhesive	White	120 ft
181-00500	SDA2X1W4	SDA2X1					Adhesive	White	120 ft
181-21001	SD2X1G4	SD2X1					Non-Adhesive	Gray	120 ft
181-00499	SDA2X1G4	SDA2X1					Adhesive	Gray	120 ft
181-21000	SD2X1BK4	SD2X1					Non-Adhesive	Black	120 ft
181-00498	SDA2X1BK4	SDA2X1					Adhesive	Black	120 ft
2" x 2" (50.8 x 50.8) Nominal Duct Size									
181-22013	SD2X2W4	SD2X2	2.03" (51.6)	2.06" (52.3)	2.00" (50.8)	Three rows of holes .50" (12.7)	Non-Adhesive	White	120 ft
181-22018	SDA2X2W4	SDA2X2					Adhesive	White	120 ft
181-22008	SD2X2G4	SD2X2					Non-Adhesive	Gray	120 ft
181-22016	SDA2X2G4	SDA2X2					Adhesive	Gray	120 ft
181-22005	SD2X2BK4	SD2X2					Non-Adhesive	Black	120 ft
181-00501	SDA2X2BK4	SDA2X2					Adhesive	Black	120 ft

Dimensions are approximate and subject to technical changes. Use **Part No.** for ordering and **Type** for specification purposes. Solid wall duct in larger sizes continued on the next page. Covers are listed on page 117.

Solid Wall Duct

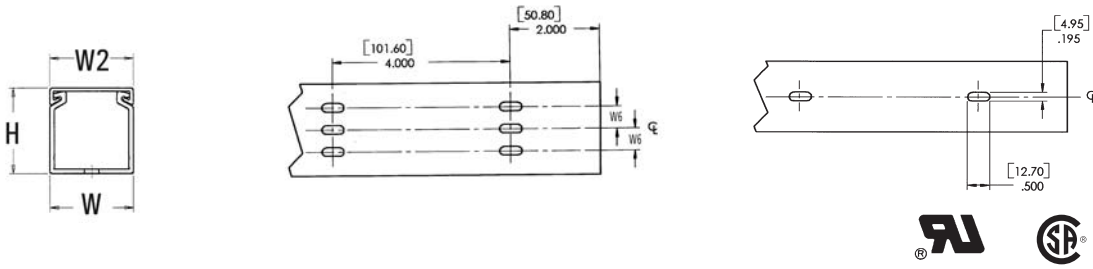

File # E64139 File # 49249

Product Selection			Width (W)	Height (H)	Width (W2)	Width (W6)	Description	Color	Pkg. Qty.
Article No.	Part No.	Type	in. (mm)	in. (mm)	in. (mm)	in. (mm)			ft. (6 ft. lengths)
2" x 3" (50.8 x 76.2) Nominal Duct Size									
181-23002	SD2X3W4	SD2X3	2.02" (51.3)	3.06" (77.7)	2.00" (50.8)	Three rows of holes .50" (12.7)	Non-Adhesive	White	120 ft
181-00504	SDA2X3W4	SDA2X3					Adhesive	White	120 ft
181-23001	SD2X3G4	SD2X3					Non-Adhesive	Gray	120 ft
181-00503	SDA2X3G4	SDA2X3					Adhesive	Gray	120 ft
181-00468	SD2X3BK4	SD2X3					Non-Adhesive	Black	120 ft
181-00540	SDA2X3BK4	SDA2X3					Adhesive	Black	120 ft
2" x 4" (50.8 x 101.6) Nominal Duct Size									
181-24002	SD2X4W4	SD2X4	2.00" (50.8)	4.06" (103.1)	2.00" (50.8)	Three rows of holes .50" (12.7)	Non-Adhesive	White	120 ft
181-00506	SDA2X4W4	SDA2X4					Adhesive	White	120 ft
181-24000	SD2X4G4	SD2X4					Non-Adhesive	Gray	120 ft
181-00505	SDA2X4G4	SDA2X4					Adhesive	Gray	120 ft
181-00469	SD2X4BK4	SD2X4					Non-Adhesive	Black	120 ft
181-00541	SDA2X4BK4	SDA2X4					Adhesive	Black	120 ft
3" x 1" (76.2 x 25.4) Nominal Duct Size									
181-31002	SD3X1W4	SD3X1	3.04" (77.2)	1.05" (26.7)	3.00" (76.2)	Three rows of holes 1.00" (25.4)	Non-Adhesive	White	120 ft
181-00508	SDA3X1W4	SDA3X1					Adhesive	White	120 ft
181-31001	SD3X1G4	SD3X1					Non-Adhesive	Gray	120 ft
181-00507	SDA3X1G4	SDA3X1					Adhesive	Gray	120 ft
181-00470	SD3X1BK4	SD3X1					Non-Adhesive	Black	120 ft
181-00672	SDA3X1BK4	SDA3X1					Adhesive	Black	120 ft
3" x 2" (76.2 x 50.8) Nominal Duct Size									
181-32003	SD3X2W4	SD3X2	3.03" (77.0)	2.06" (52.5)	3.00" (77.0)	Three rows of holes 1.00" (25.4)	Non-Adhesive	White	120 ft
181-00510	SDA3X2W4	SDA3X2					Adhesive	White	120 ft
181-32002	SD3X2G4	SD3X2					Non-Adhesive	Gray	120 ft
181-00509	SDA3X2G4	SDA3X2					Adhesive	Gray	120 ft
181-00471	SD3X2BK4	SD3X2					Non-Adhesive	Black	120 ft
181-00542	SDA3X2BK4	SDA3X2					Adhesive	Black	120 ft
3" x 3" (76.2 x 76.2) Nominal Duct Size									
181-33006	SD3X3W4	SD3X3	3.02" (76.7)	3.06" (77.7)	3.00" (76.2)	Three rows of holes 1.00" (25.4)	Non-Adhesive	White	120 ft
181-00513	SDA3X3W4	SDA3X3					Adhesive	White	120 ft
181-33004	SD3X3G4	SD3X3					Non-Adhesive	Gray	120 ft
181-00512	SDA3X3G4	SDA3X3					Adhesive	Gray	120 ft
181-33000	SD3X3BK4	SD3X3					Non-Adhesive	Black	120 ft
181-00511	SDA3X3BK4	SDA3X3					Adhesive	Black	120 ft
3" x 4" (76.2 x 101.6) Nominal Duct Size									
181-34001	SD3X4W4	SD3X4	3.00" (76.2)	4.06" (103.1)	3.00" (76.2)	Three rows of holes 1.00" (25.4)	Non-Adhesive	White	120 ft
181-00515	SDA3X4W4	SDA3X4					Adhesive	White	120 ft
181-34000	SD3X4G4	SD3X4					Non-Adhesive	Gray	120 ft
181-00514	SDA3X4G4	SDA3X4					Adhesive	Gray	120 ft
181-00472	SD3X4BK4	SD3X4					Non-Adhesive	Black	120 ft
181-00147	SDA3X4BK4	SDA3X4					Adhesive	Black	120 ft

Dimensions are approximate and subject to technical changes. Use **Part No.** for ordering and **Type** for specification purposes.

Solid wall duct in larger sizes continued on the next page. Covers are listed on page 117.

Wiring Duct

Solid Wall Duct

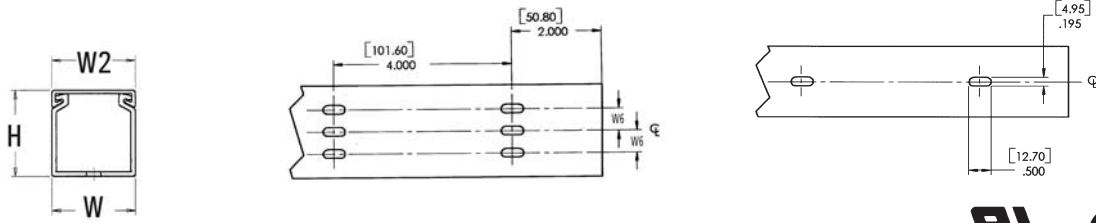

File # E64139 File # 49249

Product Selection			Width (W)	Height (H)	Width (W2)	Width (W6)	Description	Color	Pkg. Qty.
Article No.	Part No.	Type	in. (mm)	in. (mm)	in. (mm)	in. (mm)			ft. (6 ft. lengths)
3" x 5" (76.2 x 127.0) Nominal Duct Size									
181-00475	SD3X5W4	SD3X5	3.00" (76.2)	5.06" (128.5)	3.00" (76.2)	Three rows of holes 1.00" (25.4)	Non-Adhesive	White	120 ft
181-00544	SDA3X5W4	SDA3X5					Adhesive	White	120 ft
181-00474	SD3X5G4	SD3X5					Non-Adhesive	Gray	120 ft
181-00148	SDA3X5G4	SDA3X5					Adhesive	Gray	120 ft
181-00473	SD3X5BK4	SD3X5					Non-Adhesive	Black	120 ft
181-00543	SDA3X5BK4	SDA3X5					Adhesive	Black	120 ft
4" x 2" (101.6 x 50.8) Nominal Duct Size									
181-42004	SD4X2W4	SD4X2	4.03" (102.4)	2.06" (52.3)	4.00" (101.6)	Three rows of holes 1.50" (38.1)	Non-Adhesive	White	120 ft
181-00517	SDA4X2W4	SDA4X2					Adhesive	White	120 ft
181-42002	SD4X2G4	SD4X2					Non-Adhesive	Gray	120 ft
181-00516	SDA4X2G4	SDA4X2					Adhesive	Gray	120 ft
181-00476	SD4X2BK4	SD4X2					Non-Adhesive	Black	120 ft
181-00545	SDA4X2BK4	SDA4X2					Adhesive	Black	120 ft
4" x 3" (101.6 x 76.2) Nominal Duct Size									
181-43002	SD4X3W4	SD4X3	4.03" (102.4)	3.06" (77.7)	4.00" (101.6)	Three rows of holes 1.50" (38.1)	Non-Adhesive	White	120 ft
181-00519	SDA4X3W4	SDA4X3					Adhesive	White	120 ft
181-43001	SD4X3G4	SD4X3					Non-Adhesive	Gray	120 ft
181-00518	SDA4X3G4	SDA4X3					Adhesive	Gray	120 ft
181-00477	SD4X3BK4	SD4X3					Non-Adhesive	Black	120 ft
181-00546	SDA4X3BK4	SDA4X3					Adhesive	Black	120 ft
4" x 4" (101.6 x 101.6) Nominal Duct Size									
181-44015	SD4X4W4	SD4X4	4.00" (101.6)	4.06" (103.1)	4.00" (101.6)	Three rows of holes 1.50" (38.1)	Non-Adhesive	White	120 ft
181-00521	SDA4X4W4	SDA4X4					Adhesive	White	120 ft
181-44009	SD4X4G4	SD4X4					Non-Adhesive	Gray	120 ft
181-44018	SDA4X4G4	SDA4X4					Adhesive	Gray	120 ft
181-44006	SD4X4BK4	SD4X4					Non-Adhesive	Black	120 ft
181-00520	SDA4X4BK4	SDA4X4					Adhesive	Black	120 ft
4" x 5" (101.6 x 127) Nominal Duct Size									
181-45001	SD4X5W4	SD4X5	4.00" (101.6)	5.06" (128.5)	4.00" (101.6)	Three rows of holes 1.50" (38.1)	Non-Adhesive	White	60 ft
181-00523	SDA4X5W4	SDA4X5					Adhesive	White	60 ft
181-45000	SD4X5G4	SD4X5					Non-Adhesive	Gray	60 ft
181-00522	SDA4X5G4	SDA4X5					Adhesive	Gray	60 ft
181-00137	SD4X5BK4	SD4X5					Non-Adhesive	Black	60 ft
181-00547	SDA4X5BK4	SDA4X5					Adhesive	Black	60 ft
6" x 4" (152.4 x 101.6) Nominal Duct Size									
181-64001	SD6X4W4	SD6X4	6.00" (152.4)	4.07" (103.4)	6.00" (152.4)	No mounting holes	Non-Adhesive	White	60 ft
181-64000	SD6X4G4	SD6X4					Non-Adhesive	Gray	60 ft
181-00479	SD6X4BK4	SD6X4					Non-Adhesive	Black	60 ft
8" x 4" (203.2 x 101.6) Nominal Duct Size									
181-84007	SD8X4W4	SD8X4	8.00" (203.2)	4.09" (103.9)	8.00" (203.2)	No mounting holes	Non-Adhesive	White	60 ft
181-84004	SD8X4G4	SD8X4					Non-Adhesive	Gray	60 ft
181-00480	SD8X4BK4	SD8X4					Non-Adhesive	Black	60 ft

Dimensions are approximate and subject to technical changes. Use **Part No.** for ordering and **Type** for specification purposes. Covers are listed on page 117.

Slotted Wall Duct

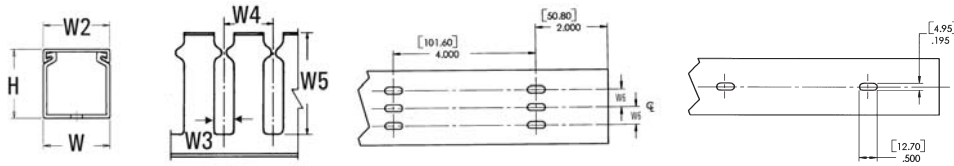

File # E64139 File # 49249

Product Selection												
Article No.	Part No.	Type	Width (W)	Height (H)	Width (W2)	Width (W3)	Width (W4)	Width (W5)	Width (W6)	Description	Color	Pkg. Qty.
			in. (mm)	in. (mm)	in. (mm)	in. (mm)	in. (mm)	in. (mm)	in. (mm)			ft. (6 ft. lengths)
1" x 1" (25.4 x 25.4) Nominal Duct Size												
181-11015	SL1X1W4	SL1X1	1.00" (25.4)	1.05" (26.7)	1.00" (25.4)	.40" (10.2)	1.00" (25.40)	.75" (19.05)	One row of holes on ⌀	Non-Adhesive	White	120 ft
181-11021	SLA1X1W4	SLA1X1								Adhesive	White	120 ft
181-11013	SL1X1G4	SL1X1								Non-Adhesive	Gray	120 ft
181-11019	SLA1X1G4	SLA1X1								Adhesive	Gray	120 ft
181-11009	SL1X1BK4	SL1X1								Non-Adhesive	Black	120 ft
181-11016	SLA1X1BK4	SLA1X1								Adhesive	Black	120 ft
1" x 1.5" (25.4 x 38.1) Nominal Duct Size												
181-11507	SL1X1.5W4	SL1X1.5	1.02" (25.91)	1.56" (26.1)	1.00" (25.40)	.40" (10.16)	1.00" (25.40)	1.19" (30.2)	One row of holes on ⌀	Non-Adhesive	White	120 ft
181-11511	SLA1X1.5W4	SLA1X1.5								Adhesive	White	120 ft
181-11505	SL1X1.5G4	SL1X1.5								Non-Adhesive	Gray	120 ft
181-11509	SLA1X1.5G4	SLA1X1.5								Adhesive	Gray	120 ft
181-00552	SL1X1.5BK4	SL1X1.5								Non-Adhesive	Black	120 ft
181-00564	SLA1X1.5BK4	SLA1X1.5								Adhesive	Black	120 ft
1" x 2" (25.4 x 50.8) Nominal Duct Size												
181-12008	SL1X2W4	SL1X2	1.03" (26.16)	2.06" (52.32)	1.00" (25.40)	.40" (10.16)	1.00" (25.40)	1.62" (41.1)	One row of holes on ⌀	Non-Adhesive	White	120 ft
181-12013	SLA1X2W4	SLA1X2								Adhesive	White	120 ft
181-12005	SL1X2G4	SL1X2								Non-Adhesive	Gray	120 ft
181-12011	SLA1X2G4	SLA1X2								Adhesive	Gray	120 ft
181-00024	SL1X2BK4	SL1X2								Non-Adhesive	Black	120 ft
181-00565	SLA1X2BK4	SLA1X2								Adhesive	Black	120 ft
1" x 3" (25.4 x 76.2) Nominal Duct Size												
181-13008	SL1X3W4	SL1X3	1.02" (25.91)	3.06" (77.72)	1.00" (25.40)	.40" (10.16)	1.00" (25.40)	2.60" (66.0)	One row of holes on ⌀	Non-Adhesive	White	120 ft
181-13012	SLA1X3W4	SLA1X3								Adhesive	White	120 ft
181-13006	SL1X3G4	SL1X3								Non-Adhesive	Gray	120 ft
181-13010	SLA1X3G4	SLA1X3								Adhesive	Gray	120 ft
181-13003	SL1X3BK4	SL1X3								Non-Adhesive	Black	120 ft
181-00566	SLA1X3BK4	SLA1X3								Adhesive	Black	120 ft
1" x 4" (25.4 x 101.6) Nominal Duct Size												
181-14006	SL1X4W4	SL1X4	1.00" (25.40)	4.06" (103.12)	1.00" (25.40)	.40" (10.16)	1.00" (25.40)	3.6" (91.4)	One row of holes on ⌀	Non-Adhesive	White	120 ft
181-00569	SLA1X4W4	SLA1X4								Adhesive	White	120 ft
181-14003	SL1X4G4	SL1X4								Non-Adhesive	Gray	120 ft
181-00568	SLA1X4G4	SLA1X4								Adhesive	Gray	120 ft
181-14001	SL1X4BK4	SL1X4								Non-Adhesive	Black	120 ft
181-00567	SLA1X4BK4	SLA1X4								Adhesive	Black	120 ft
1.5" x 1" (38.1 x 25.4) Nominal Duct Size												
181-15107	SL1.5X1W4	SL1.5X1	1.50" (38.10)	1.05" (26.67)	1.50" (38.10)	.40" (10.16)	1.00" (25.40)	.75" (19.1)	One row of holes on ⌀	Non-Adhesive	White	120 ft
181-00572	SLA1.5X1W4	SLA1.5X1								Adhesive	White	120 ft
181-15105	SL1.5X1G4	SL1.5X1								Non-Adhesive	Gray	120 ft
181-00571	SLA1.5X1G4	SLA1.5X1								Adhesive	Gray	120 ft
181-00548	SL1.5X1BK4	SL1.5X1								Non-Adhesive	Black	120 ft
181-00570	SLA1.5X1BK4	SLA1.5X1								Adhesive	Black	120 ft

Dimensions are approximate and subject to technical changes. Use **Part No.** for ordering and **Type** for specification purposes. Slotted wall duct in larger sizes continued on the next page. Covers are listed on page 117.

Wiring Duct

Slotted Wall Duct

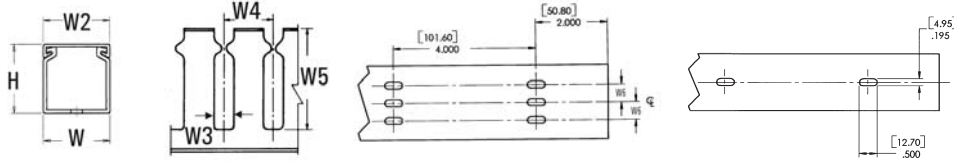

Product Selection			Width (W)	Height (H)	Width (W2)	Width (W3)	Width (W4)	Width (W5)	Width (W6)	Description	Color	Pkg. Qty.
Article No.	Part No.	Type	in. (mm)	in. (mm)	in. (mm)	in. (mm)	in. (mm)	in. (mm)	in. (mm)			ft. (6 ft. lengths)
1.5" x 1.5" (38.1 x 38.1) Nominal Duct Size												
181-15511	SL1.5X1.5W4	SL1.5X1.5	1.52" (38.61)	1.56" (34.6)	1.50" (38.10)	.40" (10.16)	1.00" (25.40)	1.19" (30.2)	One row of holes on ☑	Non-Adhesive	White	120 ft
181-15515	SLA1.5X1.5W4	SLA1.5X1.5								Adhesive	White	120 ft
181-15509	SL1.5X1.5G4	SL1.5X1.5								Non-Adhesive	Gray	120 ft
181-15513	SLA1.5X1.5G4	SLA1.5X1.5								Adhesive	Gray	120 ft
181-15505	SL1.5X1.5BK4	SL1.5X1.5								Non-Adhesive	Black	120 ft
181-00027	SLA1.5X1.5BK4	SLA1.5X1.5								Adhesive	Black	120 ft
1.5" x 2" (38.1 x 50.8) Nominal Duct Size												
181-15209	SL1.5X2W4	SL1.5X2	1.53" (38.86)	2.06" (52.32)	1.50" (38.10)	.40" (10.16)	1.00" (25.40)	1.62" (41.1)	One row of holes on ☑	Non-Adhesive	White	120 ft
181-15213	SLA1.5X2W4	SLA1.5X2								Adhesive	White	120 ft
181-15207	SL1.5X2G4	SL1.5X2								Non-Adhesive	Gray	120 ft
181-15211	SLA1.5X2G4	SLA1.5X2								Adhesive	Gray	120 ft
181-15203	SL1.5X2BK4	SL1.5X2								Non-Adhesive	Black	120 ft
181-00573	SLA1.5X2BK4	SLA1.5X2								Adhesive	Black	120 ft
1.5" x 3" (38.1 x 76.2) Nominal Duct Size												
181-15306	SL1.5X3W4	SL1.5X3	1.52" (38.61)	3.06" (77.72)	1.50" (38.10)	.40" (10.16)	1.00" (25.40)	2.60" (66.0)	One row of holes on ☑	Non-Adhesive	White	120 ft
181-15308	SLA1.5X3W4	SLA1.5X3								Adhesive	White	120 ft
181-15304	SL1.5X3G4	SL1.5X3								Non-Adhesive	Gray	120 ft
181-15307	SLA1.5X3G4	SLA1.5X3								Adhesive	Gray	120 ft
181-00550	SL1.5X3BK4	SL1.5X3								Non-Adhesive	Black	120 ft
181-00575	SLA1.5X3BK4	SLA1.5X3								Adhesive	Black	120 ft
1.5" x 4" (38.1 x 101.6) Nominal Duct Size												
181-15406	SL1.5X4W4	SL1.5X4	1.50" (38.10)	4.06" (103.12)	1.50" (38.10)	.40" (10.16)	1.00" (25.40)	3.60" (91.40)	One row of holes on ☑	Non-Adhesive	White	120 ft
181-00578	SLA1.5X4W4	SLA1.5X4								Adhesive	White	120 ft
181-15404	SL1.5X4G4	SL1.5X4								Non-Adhesive	Gray	120 ft
181-00577	SLA1.5X4G4	SLA1.5X4								Adhesive	Gray	120 ft
181-15400	SL1.5X4BK4	SL1.5X4								Non-Adhesive	Black	120 ft
181-00576	SLA1.5X4BK4	SLA1.5X4								Adhesive	Black	120 ft
2" x 1" (50.8 x 25.4) Nominal Duct Size												
181-21007	SL2X1W4	SL2X1	2.01" (51.05)	1.05" (26.7)	2.00" (50.80)	.40" (10.16)	1.00" (25.40)	.75" (19.1)	Three rows of holes .50" (12.7)	Non-Adhesive	White	120 ft
181-00580	SLA2X1W4	SLA2X1								Adhesive	White	120 ft
181-21005	SL2X1G4	SL2X1								Non-Adhesive	Gray	120 ft
181-21009	SLA2X1G4	SLA2X1								Adhesive	Gray	120 ft
181-00554	SL2X1BK4	SL2X1								Non-Adhesive	Black	120 ft
181-00579	SLA2X1BK4	SLA2X1								Adhesive	Black	120 ft
2" x 2" (50.8 x 50.8) Nominal Duct Size												
181-22028	SL2X2W4	SL2x2	2.03" (51.56)	2.00" (50.80)	2.00" (50.80)	.40" (10.16)	1.00" (25.40)	1.62" (41.1)	Three rows of holes .50" (12.7)	Non-Adhesive	White	120 ft
181-22034	SLA2X2W4	SLA2X2								Adhesive	White	120 ft
181-22024	SL2X2G4	SL2x2								Non-Adhesive	Gray	120 ft
181-22032	SLA2X2G4	SLA2X2								Adhesive	Gray	120 ft
181-22020	SL2X2BK4	SL2x2								Non-Adhesive	Black	120 ft
181-22030	SLA2X2BK4	SLA2X2								Adhesive	Black	120 ft

Dimensions are approximate and subject to technical changes. Use **Part No.** for ordering and **Type** for specification purposes.

Slotted wall duct in larger sizes continued on the next page. Covers are listed on page 117.

Slotted Wall Duct

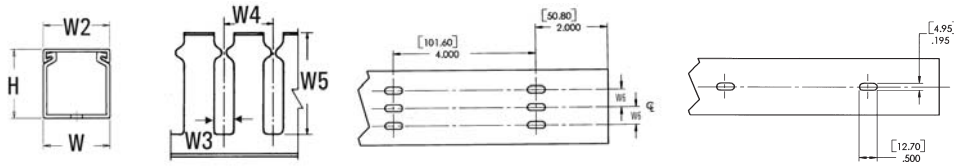

File # E64139 File # 49249

Product Selection												
Article No.	Part No.	Type	Width (W)	Height (H)	Width (W2)	Width (W3)	Width (W4)	Width (W5)	Width (W6)	Description	Color	Pkg. Qty.
			in. (mm)	in. (mm)	in. (mm)	in. (mm)	in. (mm)	in. (mm)	in. (mm)			in. (mm)
2" x 3" (50.8 x 76.2) Nominal Duct Size												
181-23009	SL2X3W4	SL2X3	2.02" (51.31)	3.00" (76.20)	2.00" (50.80)	.40" (10.16)	1.00" (25.40)	2.60" (66.0)	Three rows of holes .50" (12.7)	Non-Adhesive	White	120 ft
181-23012	SLA2X3W4	SLA2X3								Adhesive	White	120 ft
181-23007	SL2X3G4	SL2X3								Non-Adhesive	Gray	120 ft
181-00582	SLA2X3G4	SAL2X3								Adhesive	Gray	120 ft
181-23003	SL2X3BK4	SL2X3								Non-Adhesive	Black	120 ft
181-00581	SLA2X3BK4	SAL2X3								Adhesive	Black	120 ft
2" x 4" (50.8 x 101.6) Nominal Duct Size												
181-24011	SL2X4W4	SL2X4	2.00" (50.80)	4.06" (103.1)	2.00" (50.80)	.40" (10.16)	1.00" (25.40)	3.60" (91.4)	Three rows of holes .50" (12.7)	Non-Adhesive	White	120 ft
181-24014	SLA2X4W4	SLA2X4								Adhesive	White	120 ft
181-24008	SL2X4G4	SL2X4								Non-Adhesive	Gray	120 ft
181-24013	SLA2X4G4	SLA2X4								Adhesive	Gray	120 ft
181-24003	SL2X4BK4	SL2X4								Non-Adhesive	Black	120 ft
181-00583	SLA2X4BK4	SLA2X4								Adhesive	Black	120 ft
3" x 1" (50.8 x 101.6) Nominal Duct Size												
181-31007	SL3X1W4	SL3X1	3.04" (77.22)	1.00" (25.4)	3.00" (76.20)	.40" (10.16)	1.00" (25.40)	.75" (19.1)	Three rows of holes 1.00" (25.4)	Non-Adhesive	White	120 ft
181-00586	SLA3X1W4	SLA3X1								Adhesive	White	120 ft
181-00558	SL3X1G4	SL3X1								Non-Adhesive	Gray	120 ft
181-00585	SLA3X1G4	SLA3X1								Adhesive	Gray	120 ft
181-00557	SL3X1BK4	SL3X1								Non-Adhesive	Black	120 ft
181-00584	SLA3X1BK4	SLA3X1								Adhesive	Black	120 ft
3" x 2" (76.2 x 50.8) Nominal Duct Size												
181-32009	SL3X2W4	SL3X2	3.03" (76.96)	2.00" (50.80)	3.00" (76.20)	.40" (10.16)	1.00" (25.40)	1.62" (41.1)	Three rows of holes 1.00" (25.4)	Non-Adhesive	White	120 ft
181-32015	SLA3X2W4	SLA3X2								Adhesive	White	120 ft
181-32006	SL3X2G4	SL3X2								Non-Adhesive	Gray	120 ft
181-32012	SLA3X2G4	SLA3X2								Adhesive	Gray	120 ft
181-32004	SL3X2BK4	SL3X2								Non-Adhesive	Black	120 ft
181-00587	SLA3X2BK4	SLA3X2								Adhesive	Black	120 ft
3" x 3" (76.2 x 76.2) Nominal Duct Size												
181-33018	SL3X3W4	SL3X3	3.02" (76.71)	3.00" (76.20)	3.00" (76.20)	.40" (10.16)	1.00" (25.40)	2.60" (66.0)	Three rows of holes 1.00" (25.4)	Non-Adhesive	White	120 ft
181-33023	SLA3X3W4	SLA3X3								Adhesive	White	120 ft
181-33016	SL3X3G4	SL3X3								Non-Adhesive	Gray	120 ft
181-33021	SLA3X3G4	SLA3X3								Adhesive	Gray	120 ft
181-33009	SL3X3BK4	SL3X3								Non-Adhesive	Black	120 ft
181-00159	SLA3X3BK4	SLA3X3								Adhesive	Black	120 ft
3" x 4" (76.2 x 101.6) Nominal Duct Size												
181-34007	SL3X4W4	SL3X4	3.00" (76.20)	4.00" (101.60)	3.00" (76.20)	.40" (10.16)	1.00" (25.40)	3.60" (91.4)	Three rows of holes 1.00" (25.4)	Non-Adhesive	White	120 ft
181-00590	SLA3X4W4	SLA3X4								Adhesive	White	120 ft
181-34004	SL3X4G4	SL3X4								Non-Adhesive	Gray	120 ft
181-00589	SLA3X4G4	SLA3X4								Adhesive	Gray	120 ft
181-34002	SL3X4BK4	SL3X4								Non-Adhesive	Black	120 ft
181-00588	SLA3X4BK4	SLA3X4								Adhesive	Black	120 ft

Dimensions are approximate and subject to technical changes. Use **Part No.** for ordering and **Type** for specification purposes. Slotted wall duct in larger sizes continued on the next page. Covers are listed on page 117.

Slotted Wall Duct

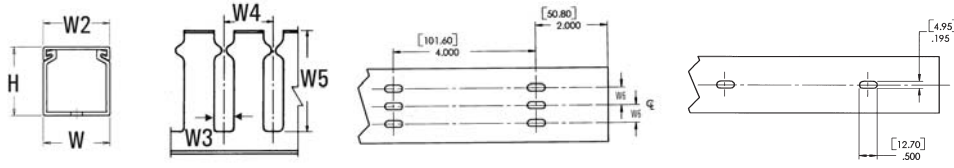

File # E64139 File # 49249

Product Selection												
Article No.	Part No.	Type	Width (W)	Height (H)	Width (W2)	Width (W3)	Width (W4)	Width (W5)	Width (W6)	Description	Color	Pkg. Qty.
			in. (mm)	in. (mm)	in. (mm)	in. (mm)	in. (mm)	in. (mm)	in. (mm)			in. (mm)
3" x 5" (76.2 x 127.0) Nominal Duct Size												
181-00560	SL3X5W4	SL3X5	3.00" (76.20)	5.00" (127.00)	3.00" (76.20)	.40" (10.16)	1.00" (25.40)	4.60" (116.8)	Three rows of holes 1.00" (25.4)	Non-Adhesive	White	120 ft
181-00156	SLA3X5G4	SLA3X5								Adhesive	White	120 ft
181-35005	SL3X5G4	SL3X5								Non-Adhesive	Gray	120 ft
181-00155	SLA3X5G4	SLA3X5								Adhesive	Gray	120 ft
181-35002	SL3X5BK4	SL3X5								Non-Adhesive	Black	120 ft
181-00157	SLA3X5BK4	SLA3X5								Adhesive	Black	120 ft
4" x 2" (101.6 x 50.8) Nominal Duct Size												
181-42010	SL4X2W4	SL4X2	4.03" (102.36)	2.06" (52.3)	4.00" (101.60)	.40" (10.16)	1.00" (25.40)	1.62" (41.1)	Three rows of holes 1.50" (38.1)	Non-Adhesive	White	120 ft
181-42014	SLA4X2W4	SLA4X2								Adhesive	White	120 ft
181-42008	SL4X2G4	SL4X2								Non-Adhesive	Gray	120 ft
181-00592	SLA4X2G4	SLA4X2								Adhesive	Gray	120 ft
181-42005	SL4X2BK4	SL4X2								Non-Adhesive	Black	120 ft
181-00591	SLA4X2BK4	SLA4X2								Adhesive	Black	120 ft
4" x 3" (101.6 x 76.2) Nominal Duct Size												
181-43006	SL4X3W4	SL4X3	4.03" (102.36)	3.00" (76.20)	4.00" (101.60)	.40" (10.16)	1.00" (25.40)	2.60" (66.0)	Three rows of holes 1.50" (38.1)	Non-Adhesive	White	120 ft
181-00594	SLA4X3W4	SLA4X3								Adhesive	White	120 ft
181-43004	SL4X3G4	SL4X3								Non-Adhesive	Gray	120 ft
181-43008	SLA4X3G4	SLA4X3								Adhesive	Gray	120 ft
181-00562	SL4X3BK4	SL4X3								Non-Adhesive	Black	120 ft
181-00593	SLA4X3BK4	SLA4X3								Adhesive	Black	120 ft
4" x 4" (101.6 x 101.6) Nominal Duct Size												
181-44031	SL4X4W4	SL4X4	4.00" (101.60)	4.00" (101.60)	4.00" (101.60)	.40" (10.16)	1.00" (25.40)	3.60" (91.4)	Three rows of holes 1.50" (38.1)	Non-Adhesive	White	120 ft
181-44035	SLA4X4W4	SLA4X4								Adhesive	White	120 ft
181-44027	SL4X4G4	SL4X4								Non-Adhesive	Gray	120 ft
181-44033	SLA4X4G4	SLA4X4								Adhesive	Gray	120 ft
181-44020	SL4X4BK4	SL4X4								Non-Adhesive	Black	120 ft
181-00595	SLA4X4BK4	SLA4X4								Adhesive	Black	120 ft
4" x 5" (101.6 x 127) Nominal Duct Size												
181-45011	SL4X5W4	SL4X5	4.00" (101.60)	5.06" (128.52)	4.00" (101.60)	.40" (10.16)	1.00" (25.40)	4.60" (116.8)	Three rows of holes 1.50" (38.1)	Non-Adhesive	White	60 ft
181-45013	SLA4X5W4	SLA4X5								Adhesive	White	60 ft
181-45010	SL4X5G4	SL4X5								Non-Adhesive	Gray	60 ft
181-00596	SLA4X5G4	SLA4X5								Adhesive	Gray	60 ft
181-45002	SL4X5BK4	SL4X5								Non-Adhesive	Black	60 ft
181-45012	SLA4X5BK4	SLA4X5								Adhesive	Black	60 ft

Dimensions are approximate and subject to technical changes. Use **Part No.** for ordering and **Type** for specification purposes.

Covers are listed on page 117.

High Density Slotted Duct

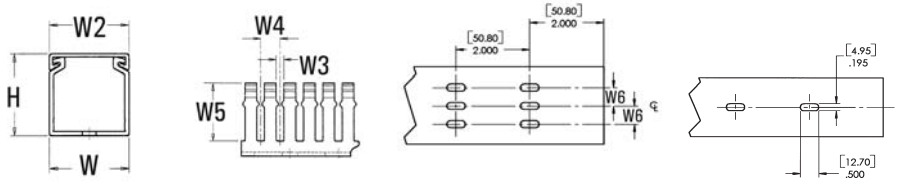

File # E64139 File # 49249

Product Selection			Width (W)	Height (H)	Width (W2)	Width (W3)	Width (W4)	Width (W5)	Width (W6)	Description	Color	Pkg. Qty. ft. (6 ft. lengths)
Article No.	Part No.	Type	in. (mm)	in. (mm)	in. (mm)	in. (mm)	in. (mm)	in. (mm)	in. (mm)			
1" x 1" (25.4 x 25.4) Nominal Duct Size												
184-11006	SLHD1X1W4	SLHD1X1	1.00" (25.4)	1.05" (26.7)	1.00" (25.4)	.16" (4.1)	.40" (10.2)	.75" (19.1)	One row of holes on Φ	Non-Adhesive	White	120 ft
181-00622	SLHDA1X1W4	SLHDA1X1								Adhesive	White	120 ft
184-11004	SLHD1X1G4	SLHD1X1								Non-Adhesive	Gray	120 ft
181-00621	SLHDA1X1G4	SLHDA1X1								Adhesive	Gray	120 ft
181-00597	SLHD1X1BK4	SLHD1X1								Non-Adhesive	Black	120 ft
181-00637	SLHDA1X1BK4	SLHDA1X1								Adhesive	Black	120 ft
1" x 1.5" (25.4 x 38.1) Nominal Duct Size												
184-11012	SLHD1X1.5W4	SLHD1X1.5	1.02" (25.9)	1.56" (39.6)	1.00" (25.4)	.16" (4.1)	.40" (10.2)	1.19" (30.2)	One row of holes on Φ	Non-Adhesive	White	120 ft
184-11009	SLHDA1X1.5W4	SLHDA1X1.5								Adhesive	White	120 ft
184-11010	SLHD1X1.5G4	SLHD1X1.5								Non-Adhesive	Gray	120 ft
184-11008	SLHDA1X1.5G4	SLHDA1X1.5								Adhesive	Gray	120 ft
181-00598	SLHD1X1.5BK4	SLHD1X1.5								Non-Adhesive	Black	120 ft
181-00623	SLHDA1X1.5BK4	SLHDA1X1.5								Adhesive	Black	120 ft
1" x 2" (25.4 x 50.8) Nominal Duct Size												
184-12007	SLHD1X2W4	SLHD1X2	1.03" (26.2)	2.06" (52.3)	1.00" (25.4)	.16" (4.1)	.40" (10.2)	1.62" (41.1)	One row of holes on Φ	Non-Adhesive	White	120 ft
184-12004	SLHDA1X2W4	SLHDA1X2								Adhesive	White	120 ft
184-12005	SLHD1X2G4	SLHD1X2								Non-Adhesive	Gray	120 ft
184-12002	SLHDA1X2G4	SLHDA1X2								Adhesive	Gray	120 ft
181-00599	SLHD1X2BK4	SLHD1X2								Non-Adhesive	Black	120 ft
181-00624	SLHDA1X2BK4	SLHDA1X2								Adhesive	Black	120 ft
1" x 3" (25.4 x 76.2) Nominal Duct Size												
184-13007	SLHD1X3W4	SLHD1X3	1.02" (25.9)	3.06" (77.7)	1.00" (25.4)	.16" (4.1)	.40" (10.2)	2.60" (66.0)	One row of holes on Φ	Non-Adhesive	White	120 ft
184-13003	SLHDA1X3W4	SLHDA1X3								Adhesive	White	120 ft
184-13005	SLHD1X3G4	SLHD1X3								Non-Adhesive	Gray	120 ft
181-00626	SLHDA1X3G4	SLHDA1X3								Adhesive	Gray	120 ft
181-00600	SLHD1X3BK4	SLHD1X3								Non-Adhesive	Black	120 ft
181-00625	SLHDA1X3BK4	SLHDA1X3								Adhesive	Black	120 ft
1" x 4" (25.4 x 101.6) Nominal Duct Size												
184-14004	SLHD1X4W4	SLHD1X4	1.00" (25.4)	4.06" (103.1)	1.00" (25.4)	.16" (4.1)	.40" (10.2)	3.60" (91.4)	One row of holes on Φ	Non-Adhesive	White	120 ft
181-00629	SLHDA1X4W4	SLHDA1X4								Adhesive	White	120 ft
184-14002	SLHD1X4G4	SLHD1X4								Non-Adhesive	Gray	120 ft
181-00628	SLHDA1X4G4	SLHDA1X4								Adhesive	Gray	120 ft
181-00601	SLHD1X4BK4	SLHD1X4								Non-Adhesive	Black	120 ft
181-00627	SLHDA1X4BK4	SLHDA1X4								Adhesive	Black	120 ft
1.5" x 1" (38.1 x 25.4) Nominal Duct Size												
184-15102	SLHD1.5X1W4	SLHD1.5X1	1.50" (38.1)	1.05" (26.7)	1.50" (38.1)	.16" (4.1)	.40" (10.2)	.75" (19.1)	One row of holes on Φ	Non-Adhesive	White	120 ft
181-00632	SLHDA1.5X1W4	SLHDA1.5X1								Adhesive	White	120 ft
184-15101	SLHD1.5X1G4	SLHD1.5X1								Non-Adhesive	Gray	120 ft
181-00631	SLHDA1.5X1G4	SLHDA1.5X1								Adhesive	Gray	120 ft
181-00602	SLHD1.5X1BK4	SLHD1.5X1								Non-Adhesive	Black	120 ft
181-00630	SLHDA1.5X1BK4	SLHDA1.5X1								Adhesive	Black	120 ft

Dimensions are approximate and subject to technical changes. Use **Part No.** for ordering and **Type** for specification purposes.

High density slotted wall duct in larger sizes continued on the next page. Covers are listed on page 117.

Wiring Duct

High Density Slotted Duct

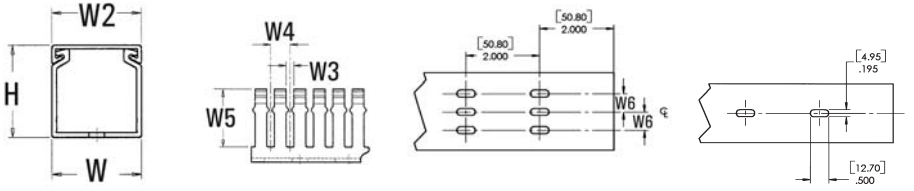



 File # E64139 File # 49249

Product Selection												
Article No.	Part No.	Type	Width (W)	Height (H)	Width (W2)	Width (W3)	Width (W4)	Width (W5)	Width (W6)	Description	Color	Pkg. Qty. ft. (6 ft. lengths)
			in. (mm)	in. (mm)	in. (mm)	in. (mm)	in. (mm)	in. (mm)	in. (mm)			
1.5" x 1.5" (38.1 x 38.1) Nominal Duct Size												
184-15155	SLHD1.5X1.5W4	SLHD1.5X1.5	1.52" (38.6)	1.56" (39.6)	1.50" (38.1)	.16" (4.1)	.40" (10.2)	1.19" (30.2)	One row of holes on Φ	Non-Adhesive	White	120 ft
184-15153	SLHDA1.5X1.5W4	SLHDA1.5X1.5								Adhesive	White	120 ft
184-15152	SLHD1.5X1.5G4	SLHD1.5X1.5								Non-Adhesive	Gray	120 ft
184-15151	SLHDA1.5X1.5G4	SLHDA1.5X1.5								Adhesive	Gray	120 ft
181-00603	SLHD1.5X1.5BK4	SLHD1.5X1.5								Non-Adhesive	Black	120 ft
181-00633	SLHDA1.5X1.5BK4	SLHD1.5X1.5								Adhesive	Black	120 ft
1.5" x 2" (38.1 x 50.8) Nominal Duct Size												
184-15206	SLHD1.5X2W4	SLHD1.5X2	1.53" (38.9)	2.06" (52.3)	1.50" (38.1)	.16" (4.1)	.40" (10.2)	1.62" (41.1)	One row of holes on Φ	Non-Adhesive	White	120 ft
184-15205	SLHDA1.5X2W4	SLHDA1.5X2								Adhesive	White	120 ft
184-15202	SLHD1.5X2G4	SLHD1.5X2								Non-Adhesive	Gray	120 ft
184-15201	SLHDA1.5X2G4	SLHDA1.5X2								Adhesive	Gray	120 ft
181-00604	SLHD1.5X2BK4	SLHD1.5X2								Non-Adhesive	Black	120 ft
181-00634	SLHDA1.5X2BK4	SLHDA1.5X2								Adhesive	Black	120 ft
1.5" x 3" (38.1 x 76.2) Nominal Duct Size												
184-15304	SLHD1.5X3W4	SLHD1.5X3	1.52" (38.6)	3.06" (77.7)	1.50" (38.1)	.16" (4.1)	.40" (10.2)	2.60" (66.0)	One row of holes on Φ	Non-Adhesive	White	120 ft
184-15301	SLHDA1.5X3W4	SLHDA1.5X3								Adhesive	White	120 ft
184-15302	SLHD1.5X3G4	SLHD1.5X3								Non-Adhesive	Gray	120 ft
181-00636	SLHDA1.5X3G4	SLHDA1.5X3								Adhesive	Gray	120 ft
181-00605	SLHD1.5X3BK4	SLHD1.5X3								Non-Adhesive	Black	120 ft
181-00635	SLHDA1.5X3BK4	SLHDA1.5X3								Adhesive	Black	120 ft
1.5" x 4" (38.1 x 101.6) Nominal Duct Size												
184-15403	SLHD1.5X4W4	SLHD1.5X4	1.50" (38.1)	4.06" (103.1)	1.50" (38.1)	.16" (4.1)	.40" (10.2)	3.60" (91.4)	One row of holes on Φ	Non-Adhesive	White	120 ft
181-00639	SLHDA1.5X4W4	SLHDA1.5X4								Adhesive	White	120 ft
184-15401	SLHD1.5X4G4	SLHD1.5X4								Non-Adhesive	Gray	120 ft
181-00638	SLHDA1.5X4G4	SLHDA1.5X4								Adhesive	Gray	120 ft
181-00606	SLHD1.5X4BK4	SLHD1.5X4								Non-Adhesive	Black	120 ft
181-00620	SLHDA1.5X4BK4	SLHDA1.5X4								Adhesive	Black	120 ft
2" x 1" (50.8 x 25.4) Nominal Duct Size												
184-21003	SLHD2X1W4	SLHD2X1	2.01" (51.1)	1.05" (26.7)	2.00" (50.8)	.16" (4.1)	.40" (10.2)	.75" (19.1)	Three rows of holes .50" (12.7)	Non-Adhesive	White	120 ft
181-00642	SLHDA2X1W4	SLHDA2X1								Adhesive	White	120 ft
184-21002	SLHD2X1G4	SLHD2X1								Non-Adhesive	Gray	120 ft
181-00641	SLHDA2X1G4	SLHDA2X1								Adhesive	Gray	120 ft
181-00607	SLHD2X1BK4	SLHD2X1								Non-Adhesive	Black	120 ft
181-00640	SLHDA2X1BK4	SLHDA2X1								Adhesive	Black	120 ft
2" x 2" (50.8 x 50.8) Nominal Duct Size												
184-22008	SLHD2X2W4	SLHD2X2	2.03" (51.6)	2.06" (52.3)	2.00" (50.8)	.16" (4.1)	.40" (10.2)	1.62" (41.1)	Three rows of holes .50" (12.7)	Non-Adhesive	White	120 ft
184-22003	SLHDA2X2W4	SLHDA2X2								Adhesive	White	120 ft
184-22005	SLHD2X2G4	SLHD2X2								Non-Adhesive	Gray	120 ft
181-00644	SLHDA2X2G4	SLHDA2X2								Adhesive	Gray	120 ft
181-00608	SLHD2X2BK4	SLHD2X2								Non-Adhesive	Black	120 ft
181-00643	SLHDA2X2BK4	SLHDA2X2								Adhesive	Black	120 ft

Dimensions are approximate and subject to technical changes. Use **Part No.** for ordering and **Type** for specification purposes. High density slotted wall duct in larger sizes continued on the next page. Covers are listed on page 117.

High Density Slotted Duct

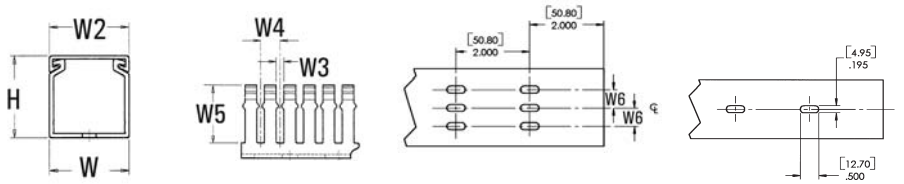

File # E64139 File # 49249

Product Selection													
Article No.	Part No.	Type	Width (W)	Height (H)	Width (W2)	Width (W3)	Width (W4)	Width (W5)	Width (W6)	Description	Color	Pkg. Qty.	
			in. (mm)	in. (mm)	in. (mm)	in. (mm)	in. (mm)	in. (mm)	in. (mm)			ft. (6 ft. lengths)	
2" x 3" (50.8 x 76.2) Nominal Duct Size													
184-23006	SLHD2X3W4	SLHD2X3								Three rows of holes .50" (12.7)	Non-Adhesive	White	120 ft
184-23003	SLHDA2X3W4	SLHDA2X3									Adhesive	White	120 ft
184-23004	SLHD2X3G4	SLHD2X3	2.02"	3.06"	2.00"	.16"	.40"	2.60"			Non-Adhesive	Gray	120 ft
181-00646	SLHDA2X3G4	SLHDA2X3	(51.3)	(77.7)	(50.8)	(4.1)	(10.2)	(66.0)			Adhesive	Gray	120 ft
181-00609	SLHD2X3BK4	SLHD2X3									Non-Adhesive	Black	120 ft
181-00645	SLHDA2X3BK4	SLHDA2X3									Adhesive	Black	120 ft
2" x 4" (50.8 x 101.6) Nominal Duct Size													
184-24007	SLHD2X4W4	SLHD2X4								Three rows of holes .50" (12.7)	Non-Adhesive	White	120 ft
184-24003	SLHDA2X4W4	SLHDA2X4									Adhesive	White	120 ft
184-24004	SLHD2X4G4	SLHD2X4	2.00"	4.06"	2.00"	.16"	.40"	3.60"			Non-Adhesive	Gray	120 ft
181-00648	SLHDA2X4G4	SLHDA2X4	(50.8)	(103.1)	(50.8)	(4.1)	(10.2)	(91.4)			Adhesive	Gray	120 ft
181-00610	SLHD2X4BK4	SLHD2X4									Non-Adhesive	Black	120 ft
181-00647	SLHDA2X4BK4	SLHDA2X4									Adhesive	Black	120 ft
3" x 1" (76.2 x 25.4) Nominal Duct Size													
181-00613	SLHD3X1W4	SLHD3X1								Three rows of holes 1.00" (25.4)	Non-Adhesive	White	120 ft
181-00652	SLHDA3X1W4	SLHDA3X1									Adhesive	White	120 ft
181-00612	SLHD3X1G4	SLHD3X1	3.02"	1.00"	3.00"	.16"	.40"	.75"			Non-Adhesive	Gray	120 ft
181-00651	SLHDA3X1G4	SLHDA3X1	(76.7)	(25.4)	(76.2)	(4.1)	(10.2)	(19.1)			Adhesive	Gray	120 ft
181-00611	SLHD3X1BK4	SLHD3X1									Non-Adhesive	Black	120 ft
181-00649	SLHDA3X1BK4	SLHDA3X1									Adhesive	Black	120 ft
3" x 2" (76.2 x 50.8) Nominal Duct Size													
184-32004	SLHD3X2W4	SLHD3X2								Three rows of holes 1.00" (25.4)	Non-Adhesive	White	120 ft
181-00655	SLHDA3X2W4	SLHDA3X2									Adhesive	White	120 ft
184-32001	SLHD3X2G4	SLHD3X2	3.03"	2.06"	3.00"	.16"	.40"	1.62"			Non-Adhesive	Gray	120 ft
181-00654	SLHDA3X2G4	SLHDA3X2	(77.0)	(52.3)	(76.2)	(4.1)	(10.2)	(41.1)			Adhesive	Gray	120 ft
181-00614	SLHD3X2BK4	SLHD3X2									Non-Adhesive	Black	120 ft
181-00653	SLHDA3X2BK4	SLHDA3X2									Adhesive	Black	120 ft
3" x 3" (76.2 x 76.2) Nominal Duct Size													
184-33004	SLHD3X3W4	SLHD3X3								Three rows of holes 1.00" (25.4)	Non-Adhesive	White	120 ft
184-33001	SLHDA3X3W4	SLHDA3X3									Adhesive	White	120 ft
184-33002	SLHD3X3G4	SLHD3X3	3.02"	3.06"	3.00"	.16"	.40"	2.60"			Non-Adhesive	Gray	120 ft
181-00657	SLHDA3X3G4	SLHDA3X3	(76.7)	(77.7)	(76.2)	(4.1)	(10.2)	(66.0)			Adhesive	Gray	120 ft
181-00615	SLHD3X3BK4	SLHD3X3									Non-Adhesive	Black	120 ft
181-00656	SLHDA3X3BK4	SLHDA3X3									Adhesive	Black	120 ft
3" x 4" (76.2 x 101.6) Nominal Duct Size													
184-34005	SLHD3X4W4	SLHD3X4								Three rows of holes 1.00" (25.4)	Non-Adhesive	White	120 ft
184-34001	SLHDA3X4W4	SLHDA3X4									Adhesive	White	120 ft
184-34003	SLHD3X4G4	SLHD3X4	3.00"	4.06"	3.00"	.16"	.40"	3.60"			Non-Adhesive	Gray	120 ft
181-00659	SLHDA3X4G4	SLHDA3X4	(76.2)	(103.1)	(76.2)	(4.1)	(10.2)	(91.4)			Adhesive	Gray	120 ft
181-00616	SLHD3X4BK4	SLHD3X4									Non-Adhesive	Black	120 ft
181-00658	SLHDA3X4BK4	SLHDA3X4									Adhesive	Black	120 ft

Dimensions are approximate and subject to technical changes. Use **Part No.** for ordering and **Type** for specification purposes. High density slotted wall duct in larger sizes continued on the next page. Covers are listed on page 117.

High Density Slotted Duct

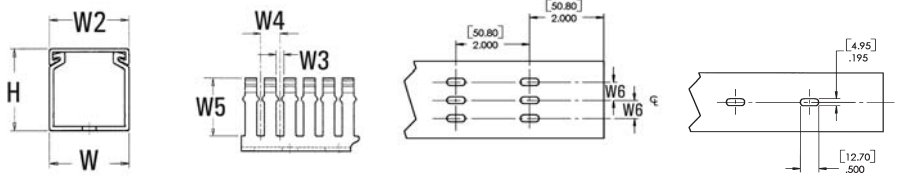

File # E64139 File # 49249

Product Selection												
Article No.	Part No.	Type	Width (W)	Height (H)	Width (W2)	Width (W3)	Width (W4)	Width (W5)	Width (W6)	Description	Color	Pkg. Qty. ft. (6 ft. lengths)
			in. (mm)	in. (mm)	in. (mm)	in. (mm)	in. (mm)	in. (mm)	in. (mm)			
4" x 2" (101.6 x 50.8) Nominal Duct Size												
184-42003	SLHD4X2W4	SLHD4X2	4.03" (102.4)	2.06" (52.3)	4.00" (101.6)	.16" (4.1)	.40" (10.2)	1.62" (41.1)	Three rows of holes 1.50" (38.1)	Non-Adhesive	White	120 ft
181-00665	SLHDA4X2W4	SLHDA4X2								Adhesive	White	120 ft
184-42001	SLHD4X2G4	SLHD4X2								Non-Adhesive	Gray	120 ft
181-00664	SLHDA4X2G4	SLHDA4X2								Adhesive	Gray	120 ft
181-00617	SLHD4X2BK4	SLHD4X2								Non-Adhesive	Black	120 ft
181-00663	SLHDA4X2BK4	SLHDA4X2								Adhesive	Black	120 ft
4" x 3" (101.6 x 76.2) Nominal Duct Size												
184-43003	SLHD4X3W4	SLHD4X3	4.03" (102.4)	3.06" (77.7)	4.00" (101.6)	.16" (4.1)	.40" (10.2)	2.60" (66.0)	Three rows of holes 1.50" (38.1)	Non-Adhesive	White	120 ft
181-00152	SLHDA4X3W4	SLHDA4X3								Adhesive	White	120 ft
184-43001	SLHD4X3G4	SLHD4X3								Non-Adhesive	Gray	120 ft
181-00153	SLHDA4X3G4	SLHDA4X3								Adhesive	Gray	120 ft
181-00618	SLHD4X3BK4	SLHD4X3								Non-Adhesive	Black	120 ft
181-00154	SLHDA4X3BK4	SLHDA4X3								Adhesive	Black	120 ft
4" x 4" (101.6 x 101.6) Nominal Duct Size												
184-44004	SLHD4X4W4	SLHD4X4	4.00" (101.6)	4.06" (103.1)	4.00" (101.6)	.16" (4.1)	.40" (10.2)	3.60" (91.4)	Three rows of holes 1.50" (38.1)	Non-Adhesive	White	120 ft
184-44001	SLHDA4X4W4	SLHDA4X4								Adhesive	White	120 ft
184-44002	SLHD4X4G4	SLHD4X4								Non-Adhesive	Gray	120 ft
181-00667	SLHDA4X4G4	SLHDA4X4								Adhesive	Gray	120 ft
181-00619	SLHD4X4BK4	SLHD4X4								Non-Adhesive	Black	120 ft
181-00666	SLHDA4X4BK4	SLHDA4X4								Adhesive	Black	120 ft

Dimensions are approximate and subject to technical changes. Use **Part No.** for ordering and **Type** for specification purposes.

Covers are listed on page 117.

Covers

Covers for Pro-Duct wiring duct are sold separately. The covers are interchangeable among the 3 styles of duct (solid, slotted and high density).

For modular packaging, remove the last digit "4" from the HellermannTyton part number. e.g., TC1G = 1" wide cover/gray/modular packaging.



File # E64139 File # 49249

Product Selection						
Article No.	Part No.	Type	Width (W)		Color	Pkg. Qty.
			in.	(mm)		ft. (6 ft. lengths)
.5" wide covers						
181-00443	TC.5W4	TC.5	.76"	(19.30)	White	120 ft
181-00442	TC.5G4	TC.5	.76"	(19.30)	Gray	120 ft
181-90050	TC.5BK4	TC.5	.76"	(19.30)	Black	120 ft
.75" wide covers						
181-00447	TC.75W4	TC.75	1.01"	(25.65)	White	120 ft
181-00446	TC.75G4	TC.75	1.01"	(25.65)	Gray	120 ft
181-00445	TC.75BK4	TC.75	1.01"	(25.65)	Black	120 ft
1" wide covers						
181-91008	TC1W4	TC1	1.00"	(25.40)	White	120 ft
181-91004	TC1G4	TC1	1.00"	(25.40)	Gray	120 ft
181-91000	TC1BK4	TC1	1.00"	(25.40)	Black	120 ft
1.5" wide covers						
181-91510	TC1.5W4	TC1.5	1.50"	(38.10)	White	120 ft
181-91507	TC1.5G4	TC1.5	1.50"	(38.10)	Gray	120 ft
181-91503	TC1.5BK4	TC1.5	1.50"	(38.10)	Black	120 ft
2" wide covers						
181-92011	TC2W4	TC2	2.00"	(50.80)	White	120 ft
181-92005	TC2G4	TC2	2.00"	(50.80)	Gray	120 ft
181-92001	TC2BK4	TC2	2.00"	(50.80)	Black	120 ft
3" wide covers						
181-93011	TC3W4	TC3	3.00"	(76.20)	White	120 ft
181-93008	TC3G4	TC3	3.00"	(76.20)	Gray	120 ft
181-93003	TC3BK4	TC3	3.00"	(76.20)	Black	120 ft
4" wide covers						
181-94014	TC4W4	TC4	4.00"	(101.60)	White	120 ft
181-94009	TC4G4	TC4	4.00"	(101.60)	Gray	120 ft
181-94003	TC4BK4	TC4	4.00"	(101.60)	Black	120 ft
6" wide covers						
181-96002	TC6W4	TC6	6.00"	(152.40)	White	60 ft
181-96000	TC6G4	TC6	6.00"	(152.40)	Gray	60 ft
181-00448	TC6BK4	TC6	6.00"	(152.40)	Black	60 ft
8" wide covers						
181-00451	TC8W4	TC8	8.00"	(203.20)	White	60 ft
181-00450	TC8G4	TC8	8.00"	(203.20)	Gray	60 ft
181-00449	TC8BK4	TC8	8.00"	(203.20)	Black	60 ft

Dimensions are approximate and subject to technical changes. Use **Part No.** for ordering and **Type** for specification purposes.

Wiring Duct

Intrinsic Blue Wiring Duct

Designed for identification purposes, HellermannTyton offers intrinsic blue Pro-Duct wiring duct. Manufactured from the same PVC material as HellermannTyton's standard duct, the blue color indicates that the wiring contained in the duct runs to intrinsically safe components in the control panel. Control panels used in chemical plants, grain elevators or other environments where explosive gases may exist are examples of where intrinsic blue duct might be needed.

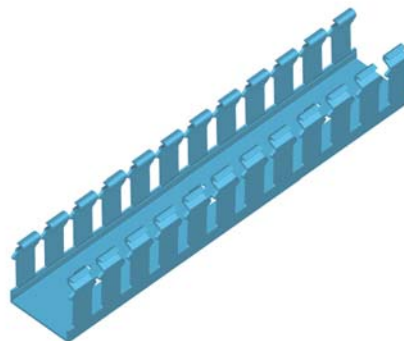

Product Selection			Width (W)		Height (H)			Pkg. Qty.
Article No.	Part No.	Type	in. (mm)		in. (mm)		Color	ft. (6 ft. lengths)
Intrinsic Blue Slotted Wall Duct								
181-11010	SL1X1BLU4	SL1x1	1.00"	(25.40)	1.05"	(26.7)	Blue	120 ft
181-12003	SL1X2BLU4	SL1X2	1.03"	(26.16)	2.06"	(52.32)	Blue	120 ft
181-13004	SL1X3BLU4	SL1X3	1.02"	(25.91)	3.06"	(77.72)	Blue	120 ft
181-15506	SL1.5X1.5BLU4	SL1.5X1.5	1.52"	(38.61)	1.56"	(34.6)	Blue	120 ft
181-00160	SL1.5X1BLU4	SL1.5X1	1.50"	(38.10)	1.05"	(26.67)	Blue	120 ft
181-22021	SL2X2BLU4	SL2x2	2.03"	(51.56)	2.00"	(50.80)	Blue	120 ft
181-23004	SL2X3BLU4	SL2X3	2.02"	(51.31)	3.00"	(76.20)	Blue	120 ft
181-33012	SL3X3BLU4	SL3X3	3.02"	(76.71)	3.00"	(76.20)	Blue	120 ft
181-44024	SL4X4BLU4	SL4X4	4.00"	(101.60)	4.00"	(101.60)	Blue	120 ft
Intrinsic Blue Duct - Covers								
181-91002	TC1BLU4	TC1	1.00"	(25.40)	n/a	n/a	Blue	120 ft
181-91505	TC1.5BLU4	TC1.5	1.50"	(38.10)	n/a	n/a	Blue	120 ft
181-92003	TC2BLU4	TC2	2.00"	(50.80)	n/a	n/a	Blue	120 ft
181-93005	TC3BLU4	TC3	3.00"	(76.20)	n/a	n/a	Blue	120 ft
181-94007	TC4BLU4	TC4	4.00"	(101.60)	n/a	n/a	Blue	120 ft

Dimensions are approximate and subject to technical changes. Use **Part No.** for ordering and **Type** for specification purposes.

Duct Notching Tool

HellermannTyton's duct notching tool is designed for use with HellermannTyton's slotted wall and slotted high density Pro-Duct wiring duct. This hand held tool features plastic grips for easy handling and allows users to notch a duct sidewall section down to the very base for finger and sidewall removal.



Product Selection					Pkg. Qty.
Article No.	Part No.	Type	Description		
182-00002	TDNT	TDNT	Notching tool		1

Dimensions are approximate and subject to technical changes. Use **Part No.** for ordering and **Type** for specification purposes.

Solid Style Wire Retainers

The solid wall wire retainer is inserted in the duct and snaps into place. The retainer can be used on any smooth, straight run of duct and can work with vertical and overhead applications. Solid wall wire retainers are manufactured from black PVC.

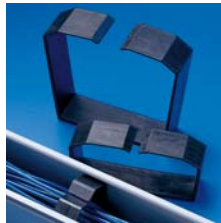

Slotted Style Wire Retainers

The slotted wall wire retainer snaps in from the outside of the duct, allowing for fast and easy installation and removal. The retainer spans approximately 90% over the duct opening for effective wire management. Slotted wall wire retainers are manufactured from black nylon 6/6.



Product Selection						
Article No.	Part No.	Type	Description	Color	Pkg. Qty.	
Solid Style Wire Retainers						
181-20201	SDWR2X20K2	SDWR2X20	Wire Retainer for 2" X 2" Solid Duct	Black	50	
181-00158	SDWR4X20K2	SDWR4X20	Wire Retainer for 4" X 2" Solid Duct	Black	50	
181-00441	SDWR4X40P2	SDWR4X40	Wire Retainer for 4" X 4" Solid Duct	Black	10	
Slotted Style Wire Retainers						
181-20021	SLWR20C2	SLWR20	Wire Retainer for 2" Wide Slotted Duct	Black	100	
181-30031	SLWR30C2	SLWR30	Wire Retainer for 3" Wide Slotted Duct	Black	100	
181-40041	SLWR40C2	SLWR40	Wire Retainer for 4" Wide Slotted Duct	Black	100	

Dimensions are approximate and subject to technical changes. Use **Part No.** for ordering and **Type** for specification purposes.

Wiring Duct Accessories

Panel Mounting Rivets and Tool

HellermannTyton panel rivets are one piece drive rivets that provide a fast, economical means of affixing wiring duct. The rivet is inserted into a 3/16" pre-punched hole and the pin is driven into the base, thereby expanding the rivet legs and locking the duct and sub-panel in place. The panel thickness (including the duct thickness) should be a maximum of 3/16". A panel rivet tool is also available for quick and easy installation of the drive rivets.



Straight Connectors

HellermannTyton's PVC straight connectors join straight duct runs to cover and protect wires. The connectors can be used with all sizes of duct. Supplied in six foot lengths, they can be cut to fit duct sidewall heights.

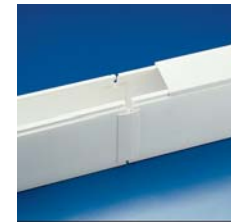

Corner Strips

HellermannTyton corner strips are supplied in six foot lengths which can be cut to provide a rounded corner for two duct sections meeting at right angles. They are made from PVC material and can be used with any size HellermannTyton wiring duct.



Product Selection					
Article No.	Part No.	Type	Description	Color	Pkg. Qty.
181-00139	PR1	PR11	Panel Rivet	Natural	1000
182-00001	PRT1	PRT1	Panel Rivet Tool	Yellow	1
181-00003	SCG	SCG	Straight Connector - gray	Gray	6ft
181-00004	SCW	SCW	Straight Connector - white	White	6ft
181-00001	CSG	CSG	Corner Strip - gray	Gray	6ft
181-00002	CSW	CSW	Corner Strip - white	White	6ft

Dimensions are approximate and subject to technical changes. Use **Part No.** for ordering and **Type** for specification purposes.

Wiring Duct

Wiring Duct Material Properties



Physical Properties	Material	ASTM Method	Test Units	Test Results
Specific Gravity (Gray)	PVC	D-792	—	1.4
Durometer Hardness	PVC	D-2240	Shore Hardness	80D
Flexural Strength	PVC	D-790	psi	12,000
Modulus of Elasticity (Tension)	PVC	D-638	psi	360,000
Dielectric Constant- 60 cps @ 30°C 60H	PVC	D-150	—	3.9
Dielectric Constant-1,000 cps @ 30° C 10°H	PVC	D-150	—	3.3
Coefficient of Thermal Conductivity	PVC	D-177	btu/in.hr.FT ² /°F	1.3
Coefficient of Linear Expansion	PVC	D-696	in./in./OF	4.0 x 10 ⁻⁵
Heat Deflection Temperature (264 psi)	PVC	D-648	°F	155
Tensile Strength (+73°F)	PVC	D-638	psi	6,600
Izod Impact Strength (+73°F)	PVC	D-256	ft. lbs./in. notch	15
Flame Resistance	PVC	D-635	—	Self-extinguishing
UL Standard 94	PVC		.029 and .062	94V-O

Wiring Capacity

Duct Size (WxH)	Duct Area (Sq. In.)	12 AWG	14 AWG	14 AWG	16 AWG	18 AWG	22 AWG
		Wire O.D.					
		0.158	0.165	0.139	0.125	0.113	0.065
.5x.5	0.18	5	4	6	7	9	27
.5x1	0.38	10	9	13	15	19	57
.75x.75	0.28	7	7	9	11	14	42
1x1	0.731	19	17	24	30	36	110
1x1.5	1.15	29	27	38	47	57	173
1x2	1.564	40	37	52	64	78	236
1x3	2.31	59	54	76	94	115	348
1x4	2.98	76	70	98	121	149	449
1.5x1	1.196	30	28	39	49	60	180
1.5x1.5	1.864	48	44	61	76	93	281
1.5x2	2.527	64	59	83	103	126	381
1.5x3	3.761	96	88	124	153	188	567
1.5x4	4.92	125	115	162	200	245	741
2x1	1.665	42	39	55	68	83	251
2x2	3.482	89	81	115	142	174	525
2x3	5.213	133	122	172	212	260	785
2x4	6.874	175	161	226	280	343	1036
3x1	2.584	66	60	85	105	129	389
3x2	5.4	138	126	178	220	269	814
3x3	8.12	207	190	267	331	405	1223
3x4	10.77	275	252	355	439	537	1623
3x5	13.44	343	314	443	548	670	2025
4x2	7.32	187	171	241	298	365	1103
4x3	11	281	257	363	448	549	1658
4x4	14.66	374	343	483	597	731	2209
4x5	18.32	467	428	604	747	913	2761
6x4	22.32	569	522	735	909	1113	3363
8x4	30.01	765	702	989	1223	1496	4522

Formula used to calculate fill capacity: Number of wires = duct area / (1.57 x (wire o.d.)²) or duct area x (0.637/(wire o.d.)²) * 50% Fill Capacity

Lightguide Fiber Optic Protection System



The Lightguide Fiber Optic Protection System is a fully enclosed system designed to isolate, route and protect fiber optic cable. This system provides a smooth, protective surface and channel to prevent fiber kinking, cutting and associated signal loss. Consisting of connectors and channels in gray or orange, the Lightguide System is easily adaptable for cable routing in a LAN, central office, data center, telecommunications office or wherever cable is run from the building entrance to its termination point. The Lightguide System is designed to be supported by existing equipment such as bays, cable racks, unistrut, threaded rod, etc., and is mounted and secured with metal hardware kits. The connectors and channels are secured by nuts and bolts or HellermannTyton's rivet fasteners.

Components

There are more than 40 components in different sizes with various horizontal and vertical transitions. System sizes include 2"x2", 4" x4", and 8" x4". Designed to provide easy re-entry, the Lightguide connectors feature a hook and loop cover attachment, eliminating fiber pinching and the need for additional hardware. When the connector cover is removed, the cable remains in place due to an inside flange providing cable retention. The complete lay-in capability of the connectors and channels eliminates the pulling of fiber and allows ease of access and tracing. The connectors and channels are designed to prevent fiber cables from exceeding the 2" minimum bend radius requirement.

HellermannTyton has simplified the assembly process by offering rivet fasteners, which do not require tools to assemble, and can connect the components to the channel. Unlike other rivets, these interlocking rivet fasteners can be easily removed and re-installed.

A 10-32 bolt also can be used for assembly.

Manufactured from a PVC/Acrylic alloy with a flammability rating of UL94V-0, the connectors possess an oxygen index of 37 with a maximum continuous temperature rating of 122° Fahrenheit.

Protective Channel

The protective channel is available in 6 foot lengths as solid or slotted with snap-on covers. The solid channel provides fiber routing and protection for all straight horizontal runs. The slotted channel is designed for vertical drops from the overhead environment down to the front face of the equipment bay. The slotted fingers can be broken off to create a custom size opening so the fiber and cable can branch out to the equipment. The snap-on covers easily interlock with the channel and feature a non-slip surface.

Both styles of protective channel and cover are manufactured from a rigid, non-flammable polyvinyl chloride. This material is 94V-0 rated with an oxygen index of 40 to 48 per ASTM 2863.

Routing and Raceway Products

Lightguide Fiber Optic Protection System

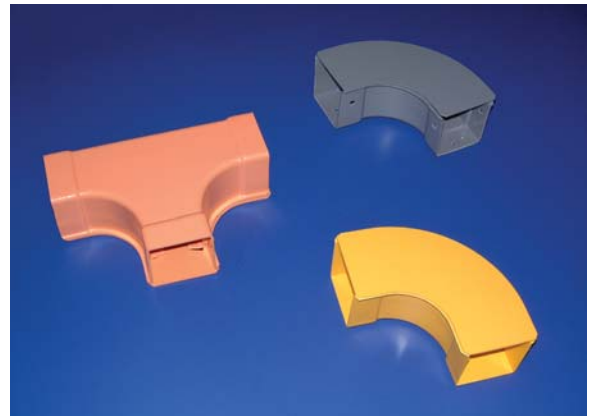
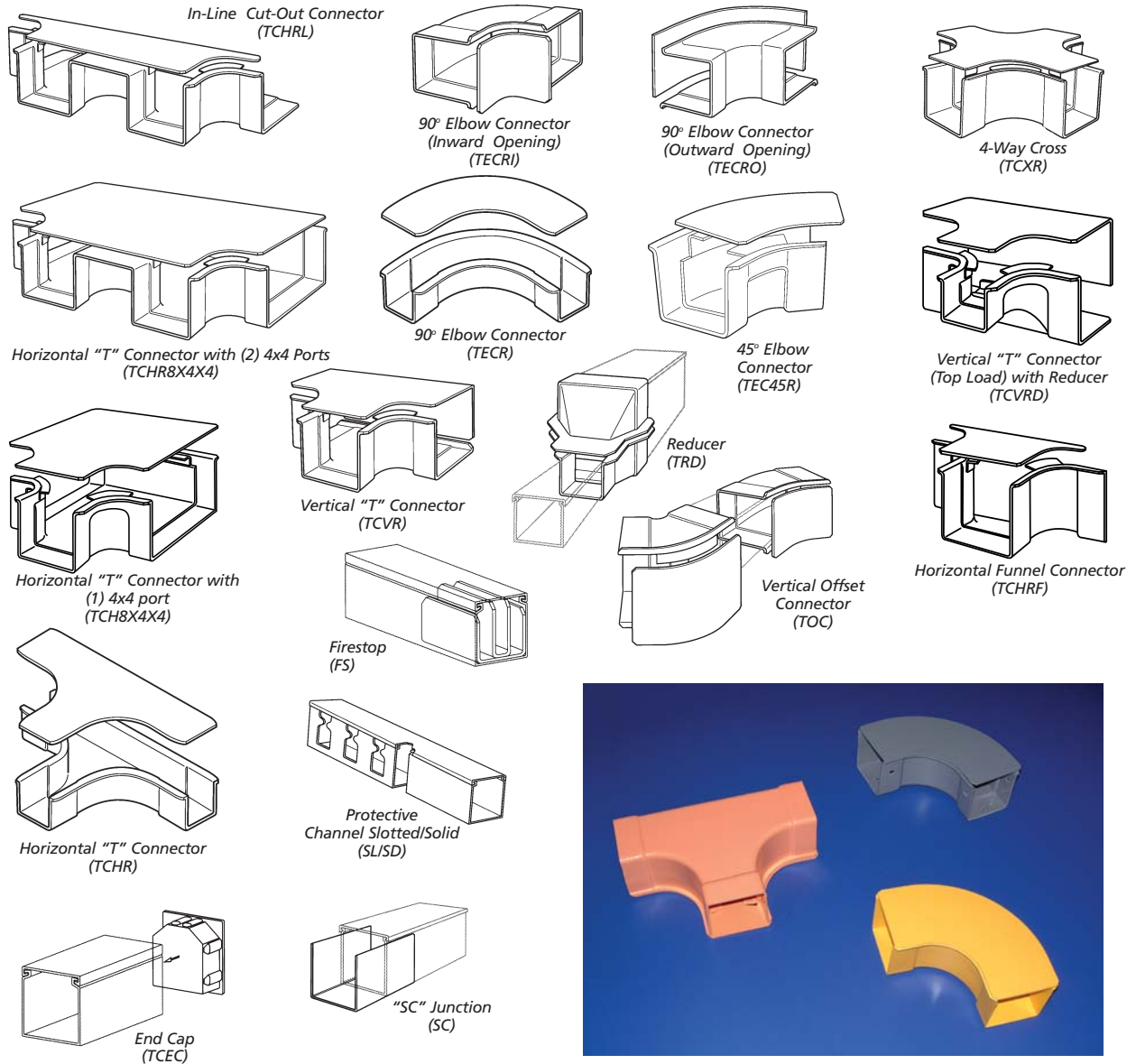

Product Selection

Part Number	Description	Pkg. Qty.
2" x 2" System		
TOC2x2X	Vertical Offset Connector (Inward & Outward Set)	1
TCVR2x2X	Vertical "T" Connector (Top Load)	1
TCVRD2x2X	Vertical "T" Connector (Top Load) with 2" to 1" reducer	1
TCXR2x2X	4-Way Cross	1
TECRO2x2X	90° Elbow Connector (Outward Opening)	1
TECRI2x2X	90° Elbow Connector (Inward Opening)	1
TECR2x2X	90° Elbow Connector	1
TEC45R2x2X	45° Elbow Connector	1

Replace "X" in the part number with the following letters for desired color: X = G (gray) or ORN (orange) is available in selected fittings. Please call HellaermannTyton customer service for availability, lead times and minimums on fittings - not all colors available.

Routing and Raceway Products

Lightguide Fiber Optic Protection System

Product Selection

Part Number	Description	Pkg. Qty.
2" x 2" System		
TCHR2x2X	Horizontal "T" Connector	1
TCEC2x2X	End Cap	1
FS2x2X	Firestop Support	1
SC2x2X	Straight Connector (Junction)	1
TRD2x1X	2" to 1" Reducer	1
SD2x2X/TC2	2" x 2" Solid Channel with Cover	30 feet of 6 foot lengths
SL2x2X/TC2	2" x 2" Slotted Channel with Cover	30 feet of 6 foot lengths
4" x 4" System		
TOC4x4X	Vertical Offset Connector (Inward & Outward Set)	1
TCVR4x4X	Vertical "T" Connector (Top Load)	1
TCVRD4x4X	Vertical "T" Connector (Top Load) with 4" to 2" Reducer	1
TCXR4x4X	4-Way Cross	1
TECRO4x4X	90° Elbow Connector (Outward Opening)	1
TECR14x4X	90° Elbow Connector (Inward Opening)	1
TECR4x4X	90° Elbow Connector	1
TEC45R4x4X	45° Elbow Connector	1
TCHR4x4X	Horizontal "T" Connector	1
TCHRD4x4X	Horizontal "T" Connector with 4" to 2" Reducer	1
TCHRF4x4X	Horizontal Funnel Connector	1
TCEC4x4X	End Cap	1
FS4x4X	Firestop Support	1
SC4x4X	Straight Connector (Junction)	1
TRD4x2X	4" x 4" to 2" x 2" Reducer	1
SD4x4X/TC4	4" x 4" Solid Channel with Cover	30 feet of 6 foot lengths
SL4x4X/TC4	4" x 4" Slotted Channel with Cover	30 feet of 6 foot lengths
SDWR4x40P2	Wire Retainer for 4" x 4" Solid Channel, Black	10 pieces per bag
SLWR40C2	Wire Retainer for 4" x 4" Slotted Channel, Black	100 pieces per bag
8" x 4" System		
TOC8x4X	Vertical Offset Connector (Inward & Outward Set)	1
TCXR8x4X	4-Way Cross	1
TECRO8x4X	90° Elbow Connector (Outward Opening)	1
TECR8x4X	90° Elbow Connector	1
TCHR8x4X	Horizontal "T" Connector	1
TCH8x4x4X	Horizontal "T" Connector with one 4" x 4" port	1
TCHR8x4x4X	Horizontal "T" Connector with two 4" x 4" ports	1
TCHRL8x4x4X	In-Line Cut-Out Connector with two 4" x 4" ports	1
TCEC8x4X	End Cap	1
SC8x4X	Straight Connector (Junction)	1
TRD8x4x4X	8" x 4" to 4" x 4" Reducer	1
SD8x4X/TC8	8" x 4" Solid Channel with Cover	30 feet of 6 foot lengths

Replace "X" in the part number with the following letters for desired color: X = G (gray) or ORN (orange) is available in selected fittings.
Please call HellermannTyton customer service for availability, lead times and minimums on fittings - not all colors available.

Converter Kit

When the complete connection of duct and tubing is required, or rigid Lightguide components may not fit through a certain area, the converter kit can be used.

The kit consists of two gray PVC connectors, a section of black convoluted tubing, and two black Snapper clamps (SNP42) to secure the converters to the tubing. The black convoluted tubing is available in lengths of 2 feet, 4 feet, and 6 feet. The converter kit provides a smooth transition from 2" x 2" Lightguide to 1-1/2" flexible tubing.



Product Selection

Part Number	Description	Pkg. Qty.
TFJK2X2	Kit containing two gray connectors, 2 foot section black convoluted tubing & two black Snapper clamps.	1
TFJK2X2-4	Kit containing two gray connectors, 4 foot section black convoluted tubing & two black Snapper clamps.	1
TFJK2X2-6	Kit containing two gray connectors, 6 foot section black convoluted tubing & two black Snapper clamps.	1
TJ2XRD	Gray connector	1