

1051-19: T48" x 48"

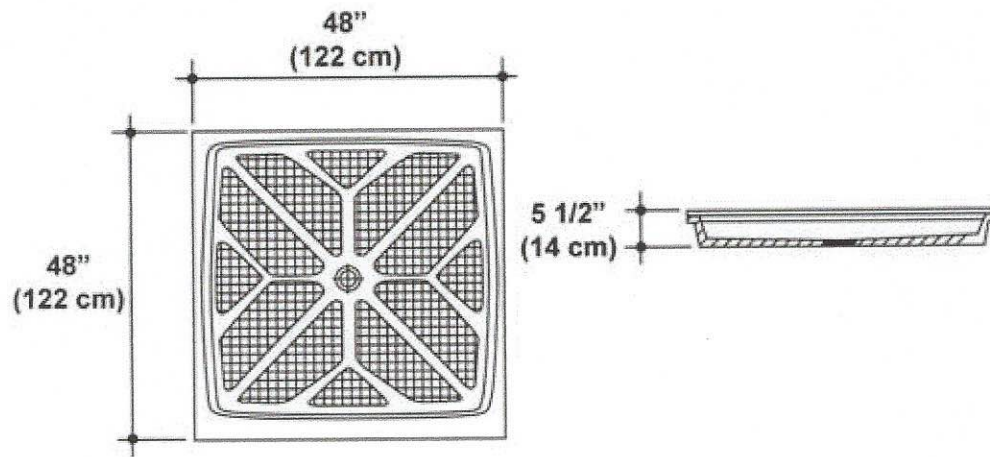

Description/Order No (#)

Male

1051-19 Shower Pan T48" x 48" - #23071

Female

F-1051-19 Shower Pan - #430718

F-1051-19 Turtle - #4307181

Lightweight Female 1/2"

F-1051-19 Combo Insert - #430719

Cast Weight Specs: Gross Weight = 299 lb; Net Weight (w/ Insert) = 206 lb; Net Weight (w/ Turtle) = 165 lb