

There are several notes I need to provide to aid you with the enclosed package. The original kits used 1/16" balsa. Since I wanted to print these directly on balsa sheet I developed the parts for 1/32" balsa sheet. My printer will handle up to 1/20" sheet, but I find 1/32" is a little easier to handle in the printer. As a result, some of the parts have been drawn to allow for cross grain laminations. The fuselage formers are a good example. The fin as also been drawn with a mirror image to allow for markings on both sides. This works fine as long as you are using 1/32" sheet stock.

Since the Ranger 21 does not use wing struts, 1/32" sheet wings are very marginal in strength for this model. As a result, I recommend that after printing the wings, you laminate a second layer to the bottom of each wing sheet before cutting out the parts. I have had good results with white glue that is spread very thin with a scrap of thin cardboard or a piece of balsa sheet. This will produce a much stronger wing with minimal weight gain. The wing halves are laminated flat. The wing camber is generated by the fuselage as was the case for the original kits.

I like to use a removable nose for winding. The parts have been drawn with this in mind. An un-colored nose former has been drawn that is to be part of the fuselage structure. A colored nose piece has also been drawn. The piece when backed with a piece of 1/64" plywood becomes the removable part. The nose former is located to allow the removable piece to nestle inside the fuselage sheeting. I like to use a Peck thrust bearing for 1/32" prop shafts in the removable nose piece. Please see the diagram that comes just before the scanned kit plan in this package.

When using 1/32" sheet for the fuselage sides, I was concerned about the load of a fully wound motor on the rear motor peg. I like to use a piece of 3/32" aluminum tubing for the rear peg. Makes holding the model in a winding stoooge very easy. To create a bit more strength at the rear peg, I apply a 3/8" diameter disk of plywood to the inside of each fuselage side at the peg location. This has proven to be more than adequate for a fully wound motor of 1/8" Tan II rubber. A piece of 3/32" OD aluminum tubing is used for the rear motor peg.

The kit Ranger 21 used a formed plastic nose to support the prop thrust bearing. I have drawn the reproduction to use a nose similar to the Top Flite Jigtime Rascal 18. Also, the kit Ranger 21 did not include a pilot figure. I like the pilot figures that were included in the Jigtime series, so I borrowed the pilot from the Rascal 18. It was scaled up in size to match the larger Ranger 21. It is included in the parts drawings should you want to add a pilot to your Ranger 21.

The original Goldberg kits did not have any color applied to the balsa. I have added color and markings in a manner similar to the old Top Flite Jigtime models. Carl Goldberg was responsible for the Jigtime series when he was with Top Flite. The colors chosen are based on the kit box art.

I do hope you build and enjoy a model from this plan package.

Paul Bradley

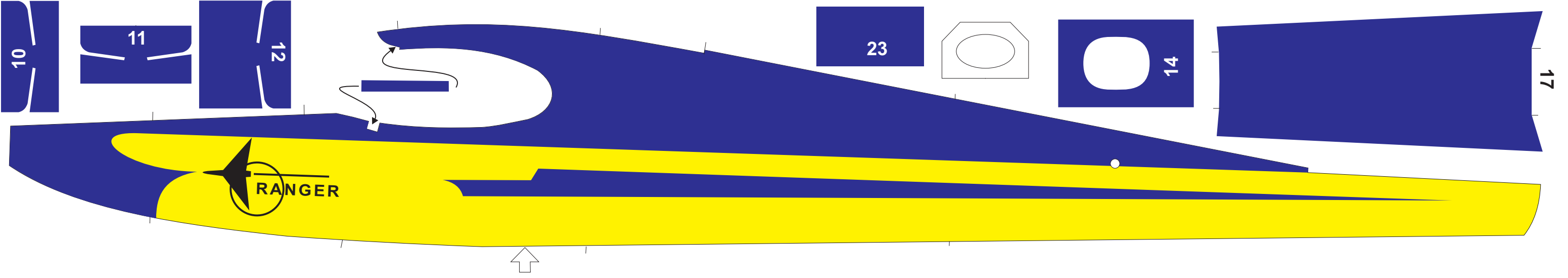

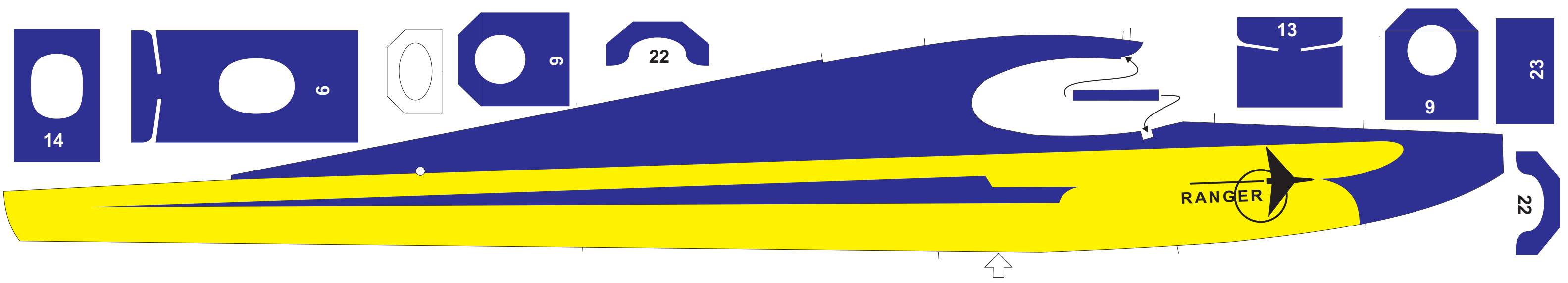

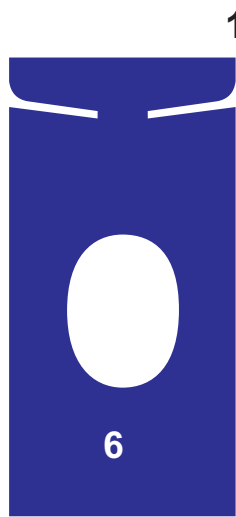
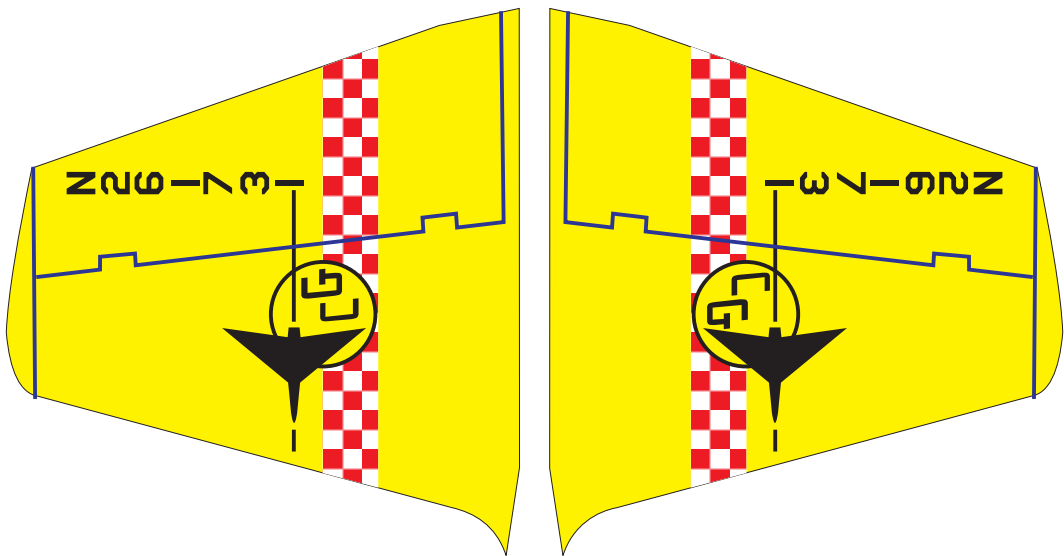

16

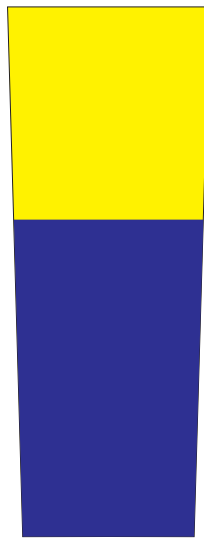
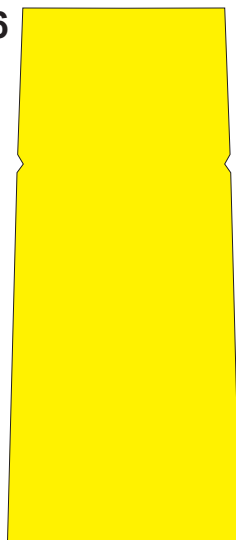

15

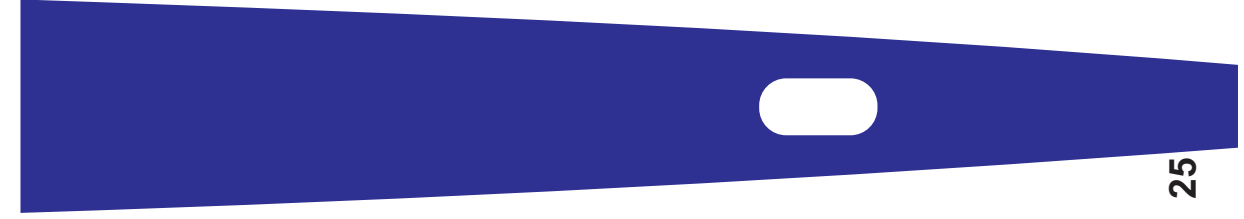

25

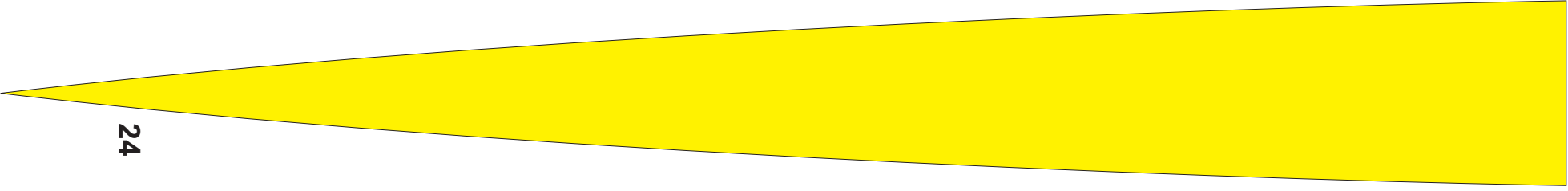

24

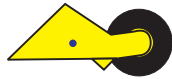
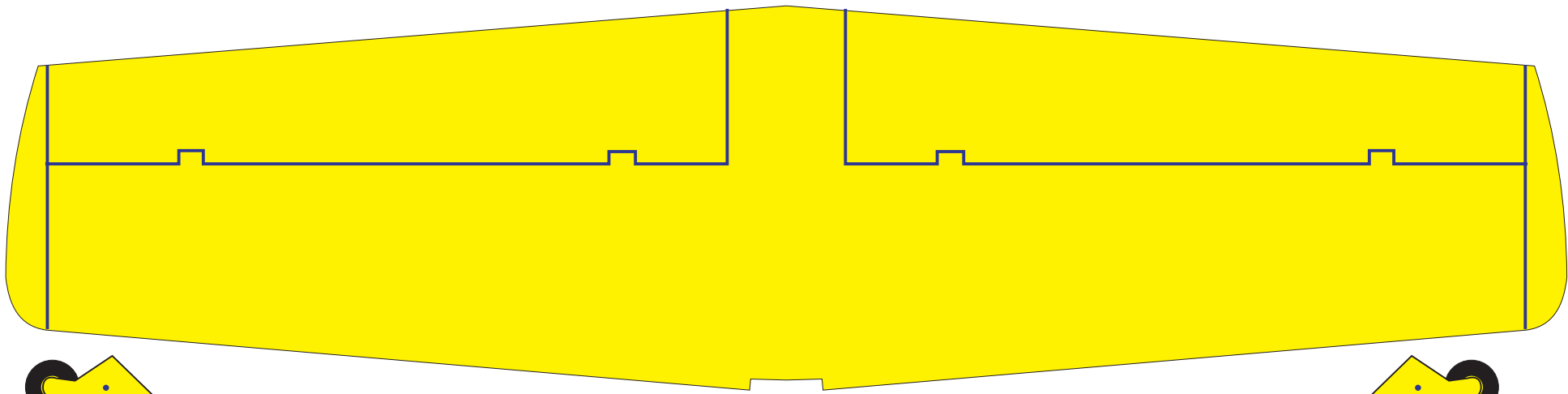

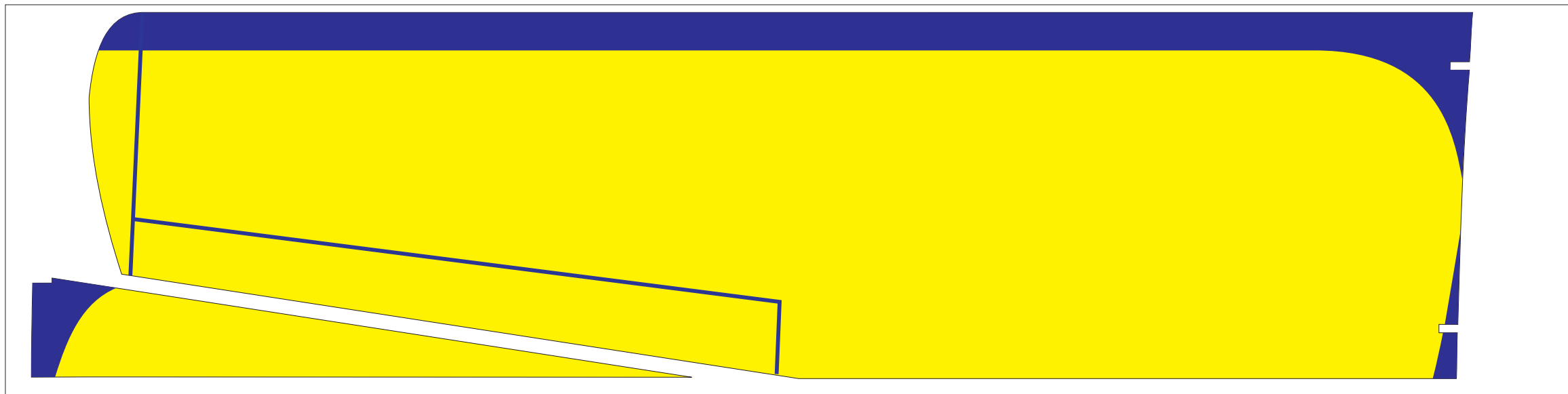

N261731

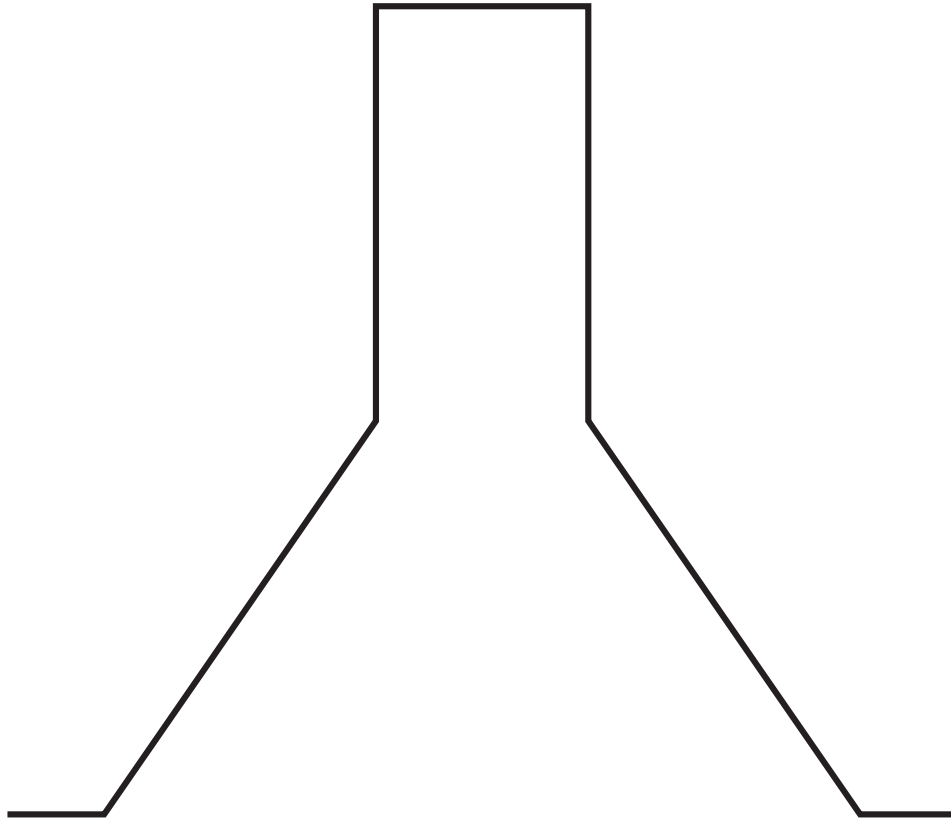

Make landing gear from .032 music wire.

Use 3/4" to 1" wheels

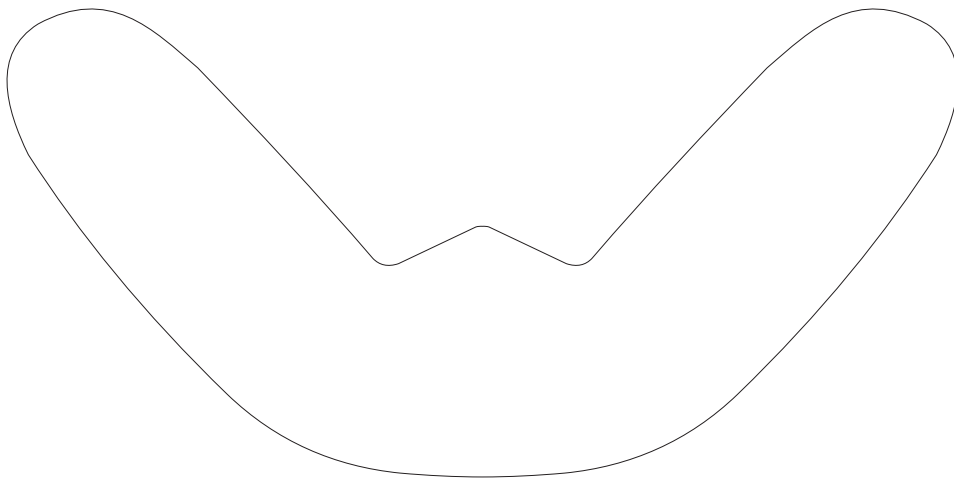

Ranger 21

The Ranger 21 is a simple but thrilling rubber-powered flying model. Its proportions and methods of construction have been worked out through many years of experimenting, so as to give you a strong, light, and efficient airplane. The lines of the Ranger remind you of training planes seen at your local airport. However, it is slimmer and does not have wing struts, so it cuts through the air with less drag. This allows it to climb higher and glide flatter for more distance and duration in the air.



RANGER 21

FLYING MODEL, KIT D3

FLIES 15-30 SEC., 150.

Wingspan 21"
 Length 16 1/2"
 Weight 1 1/4 oz.

Designed and
 Built by
 Carl Goldberg



CARL GOLDBERG MO

L.I.L. JUMPER BEAN
KIT G 8

RANGER 30
KIT G 2

CHICAGO

CESNA 180
KIT D 4

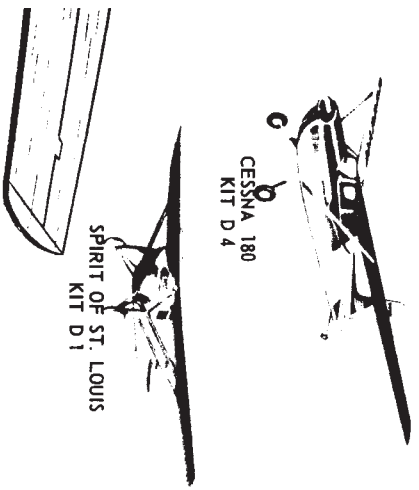

SPIRIT OF ST. LOUIS
KIT D 1

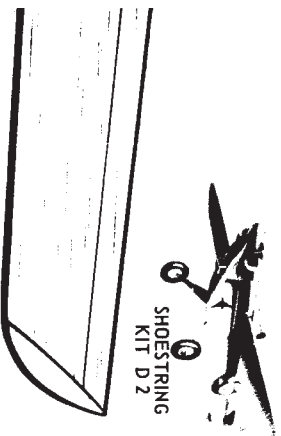

SHOESTRING
KIT D 2

RANGER 21

MODEL, KIT D3

DESIGNED AND DRAWN BY:
CARL GOLDBERG
1 1/2 OZ.
1 1/4 OZ.

Designed and drawn by:
Carl Goldberg
1 1/2" 16 1/2"
1 1/4 oz. Carl Goldberg
FLYING MODELS, INC.

FLYING MODELS, INC.

YOUR SUGGESTIONS WANTED!

Modelers often have ideas for improvements. We will be happy to hear from you by post card or letter on:

1. Your suggestions.
2. What you like best about our models.
3. What three new models you'd like to see us bring out.

Be sure to include your name, age, and address so we can reply and thank you.

HOW TO WIN YOUR PILOT'S LICENSE!

A pilot must of course study, practice and finally pass certain tests before he can win the coveted certificate. The performance standard set for your model is not difficult, but it will take some effort. So read the following carefully.

First, build your model carefully and accurately, following instructions. Cement all the joints firmly. Sand the entire model neat and smooth, with rounded edges especially on the wing and tail. Keep it light!

Second, follow the Flying Instructions to get your model in perfect "flying trim." Get lots of practice in flying it, and learn to make small adjustments to help it fly more smoothly. Study and follow the section on How to Make Extra Long Flights. Keep practicing.

Third, have your model timed to see how long it can stay up. The timer can be your teacher, scoutmaster, parent or a friend, and should use a stopwatch or a sweep-second watch. When you have successfully achieved the necessary time as shown in the application, fill it out and send it in with 10c to cover the handling and mailing costs. Within a short time (allow three weeks), you will receive a handsome certificate inscribed in your name, giving real recognition to your building and flying achievements!

FLYING INSTRUCTIONS

RUBBER BAND

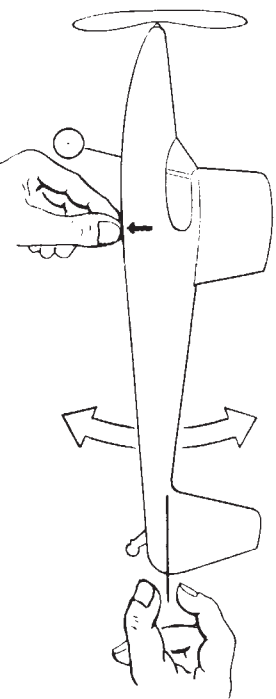

2 Balance model as shown. Add modeling clay to front or rear to make model balance at arrow.

WIRE

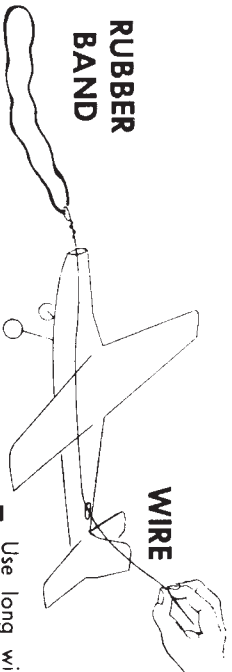

1 Use long wire (from hobby shop, florist or hardware) to help install rubber motor. Insert dowel at rear.

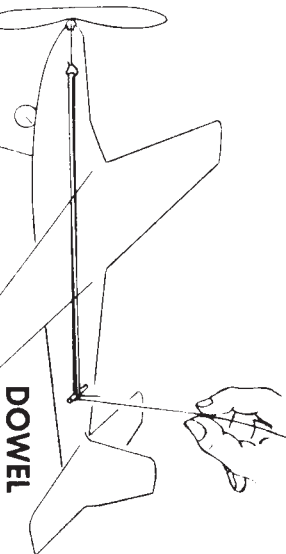

DOWEL

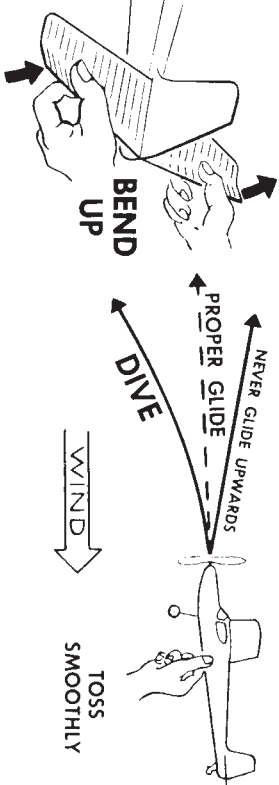

3 Make test glides over tall grass. Should model dive, bend tail up a little at a time until the glide is smooth.

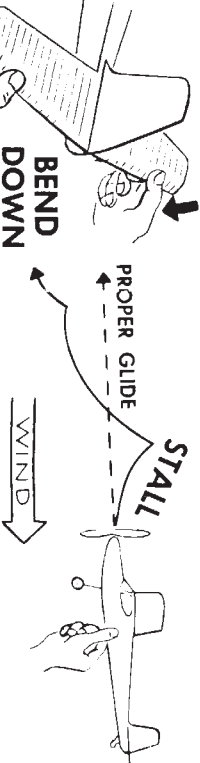

BEND DOWN

STALL

PROPER GLIDE

WIND

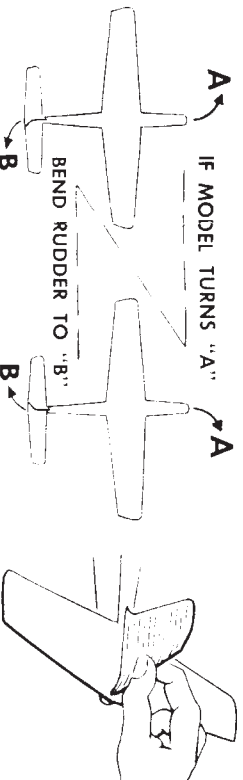

A IF MODEL TURNS "A"

B BEND RUDDER TO "B"

TOSS SMOOTHLY

To Carl Goldberg Models, Inc.

LICENSE APPLICATION

Chicago Ill.

I am enclosing 10c to cover the costs of handling and mailing my pilot's license. My plane, Ranger 21, had to fly at least 16 seconds to qualify. It made a flight of ... seconds.

Name

Age

Address

Timer's Signature

City

State

15 model uses bend rudder for opposite turn in order to start straight

Here's HOW TO MAKE YOUR MODEL RIGHT!

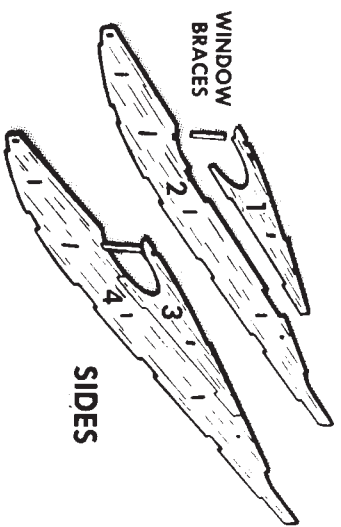

1 Use regular model airplane cement to join the fuselage side pieces as shown.

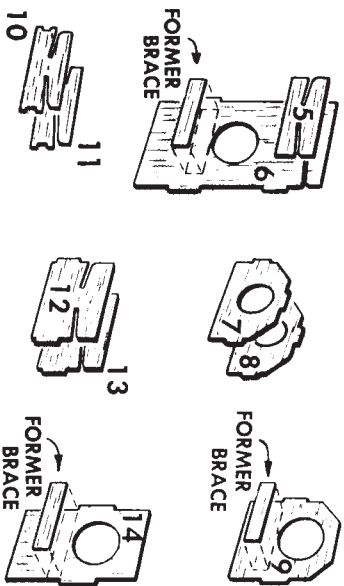

2 Carefully cement together the various parts pictured above.

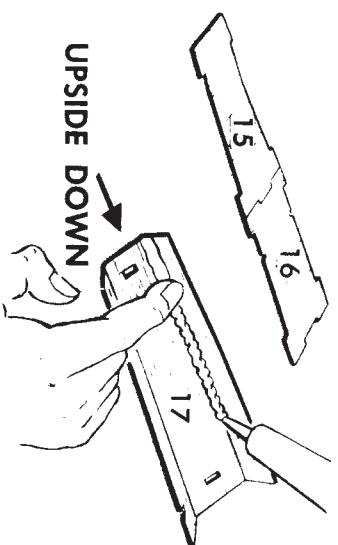

3 Cement 15 and 16 together. Turn 17 upside down, and rub cement into the underside of the creases.

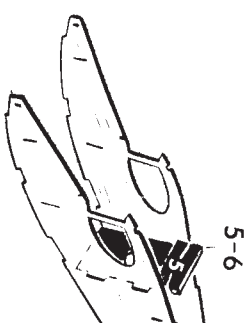

4 Cement formers 5-6 between accurately cement rear of

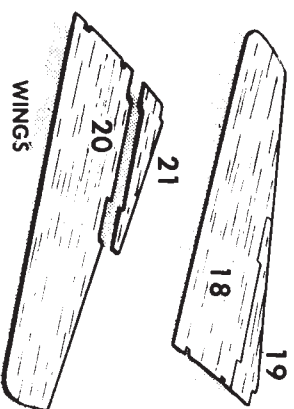

5 Join the wing parts as shown.

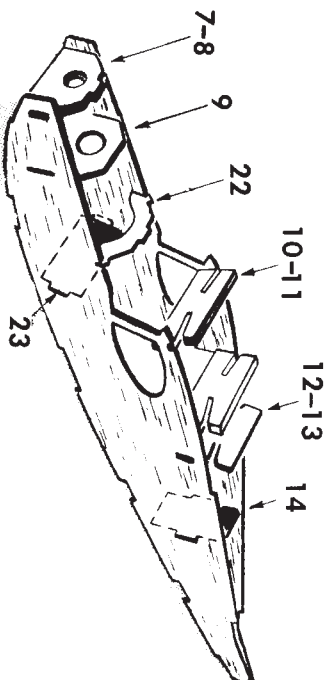

6 Cement in place all the remaining formers.

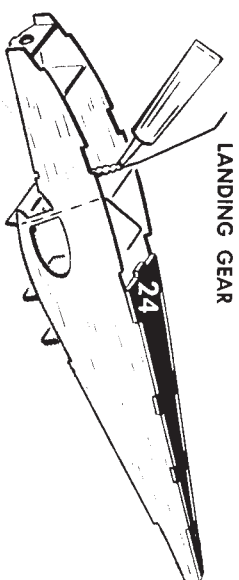

7 Set 24 in place, and cement while in position. Wipe off excess cement until shine is gone. Cement landing gear firmly.

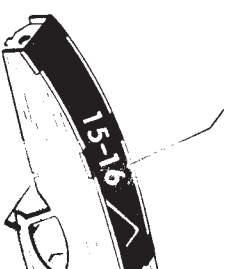

8 Set 15-16 in place, cement in position.

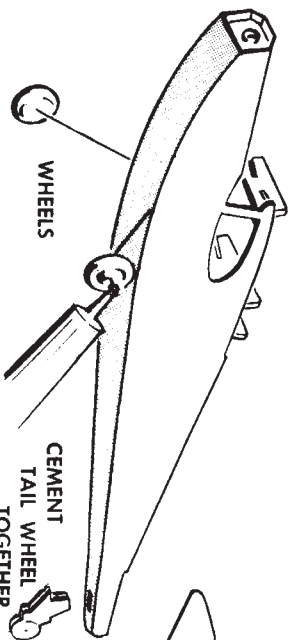

11 Add wheels and tail wheel. Put drop of cement on ends of axles without touching wheels.

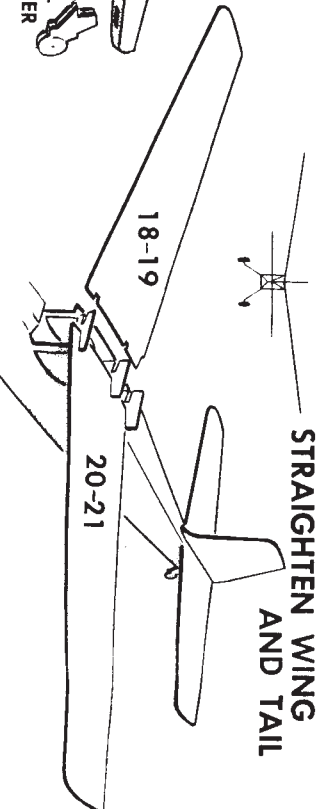

STRAIGHTEN WING AND TAIL

12 Cement wings and tail carefully in place. Look at model from front and rear for correct line-up. Straighten before cement dries.

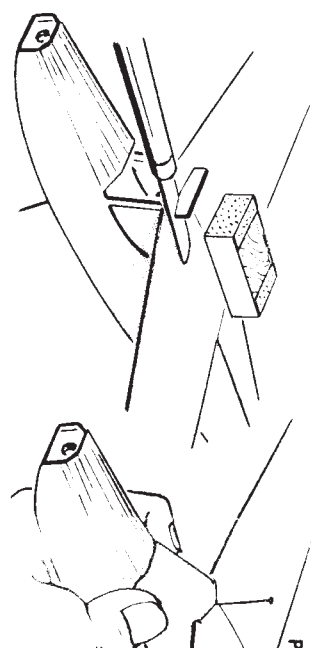

13 When cement is dry, cut off tops of formers and so windshield in place.

RIGHT!

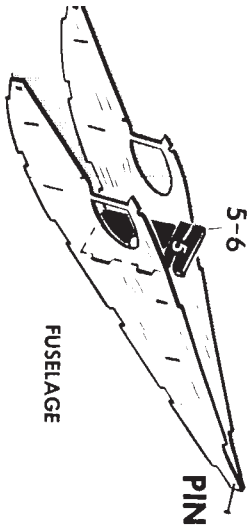

FUSELAGE

PIN

4 Cement formers 5-6 between fuselage sides. Very accurately cement rear of fuselage together.

4 Should model stall and dip (first climb, then dive), bend tail down a bit or a time until the glide is smooth and flat.

HOW TO GET EXTRA LONG FLIGHTS!

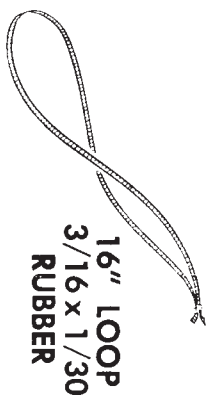

16" LOOP
3/16 x 1/30
RUBBER

6 For a longer, more powerful motor, see your dealer for rubber 3/16 x 1/30 x 32". The ends with a square knot. Rub castor oil into the motor so it can take many more turns without breaking. Don't get castor oil on the knot or it will come undone, and you'll have to rub dust into it to get the knot to hold.

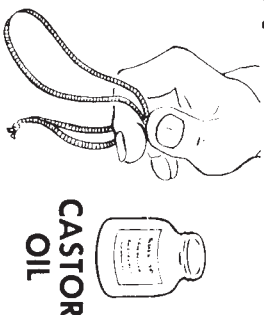

CASTOR
OIL

Learn to wind with a drill, with a hook firmly tightened in place for winding. Stretch the motor 3 to 5 times its length, and wind while coming back in gradually. You should have about 3/5 of your intended number of turns by the time you have come back in about 1/5 of the distance.

5 If model turns, bend rudder for opposite turn in order to get straight flights. Wind motor 100 turns, and make several test flights. Make corrections for better flights by bending tail as in steps 3 and 4.

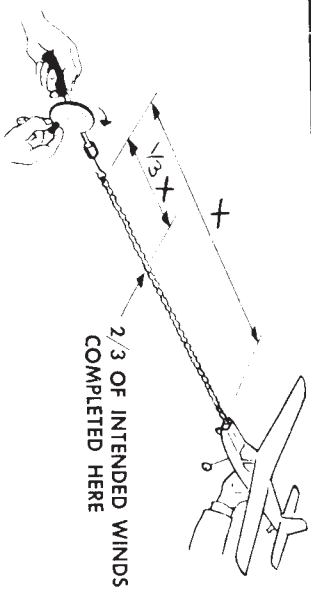

2/3 OF INTENDED WINDS
COMPLETED HERE

Practice winding for maximum turns and power. It's best to practice with the motor outside the plane, hooked on a nail, in case it should break. You should be able to get from 750 to 1000 turns. In good, calm flying weather, and with your plane adjusted to fly smoothly, this amount of turns should enable you to get long flights of 20 to 30 seconds duration. Good luck!

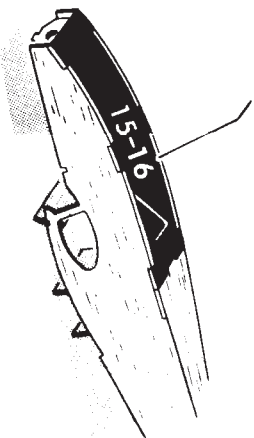

15-16

8 Set 15-16 in place, and cement while in position.

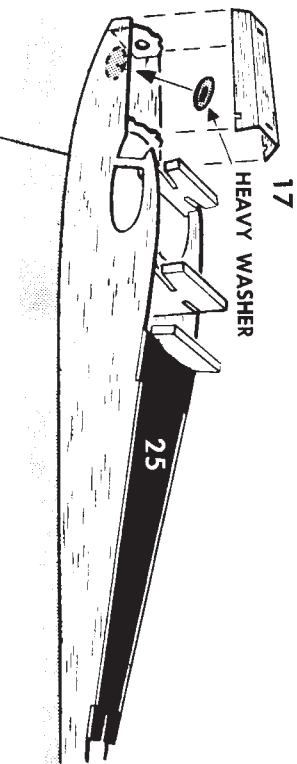

17

HEAVY WASHER

25

9 Cement balance weight washer in place, then cement 17 to top front fuselage. Set 25 in place, and cement while in position.

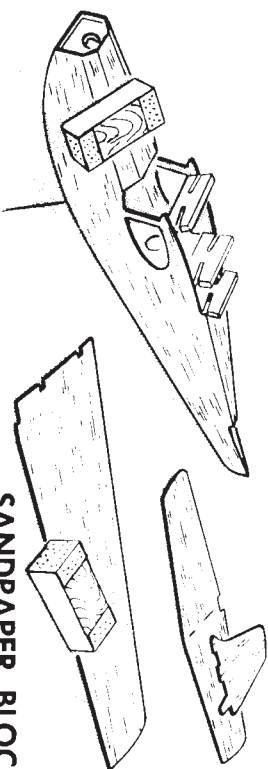

SANDPAPER BLOCK

10 Sand all parts smooth except formers, using 4/0 sandpaper. Round off square edges on fuselage, wings and tail except where parts join.

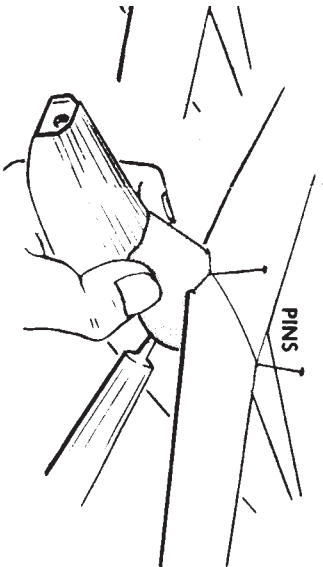

PINS

, cut off tops of formers and sand smooth. Cement

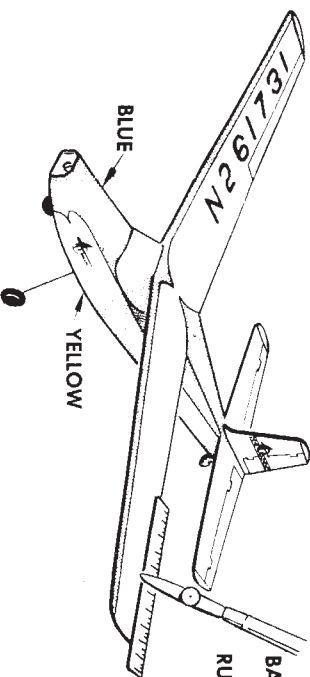

BLUE

YELLOW

BALL POINT
OR
RULING PEN

14

Model may be clear doped one thin coat and sanded smooth. Add trim lines and decals. Keep model light for long flights. If beauty is more important, apply 2 thin coats color dope before lines and decals.

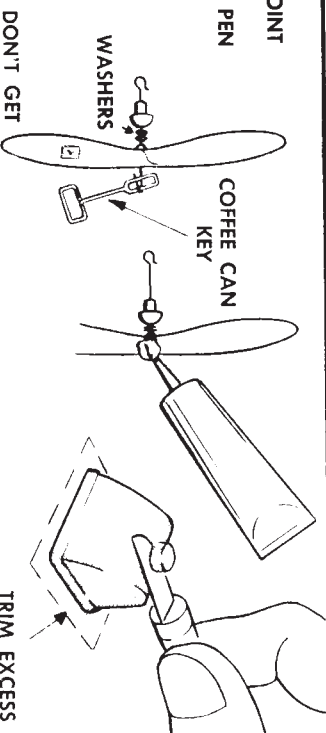

WASHERS

COFFEE CAN
KEY

DON'T GET
PROP BACKWARDS

TRIM EXCESS

15

Assemble propeller parts as shown. Bend and cement shaft to prop. Trim excess off nose.